

# ELECTRONIC INDUSTRIES

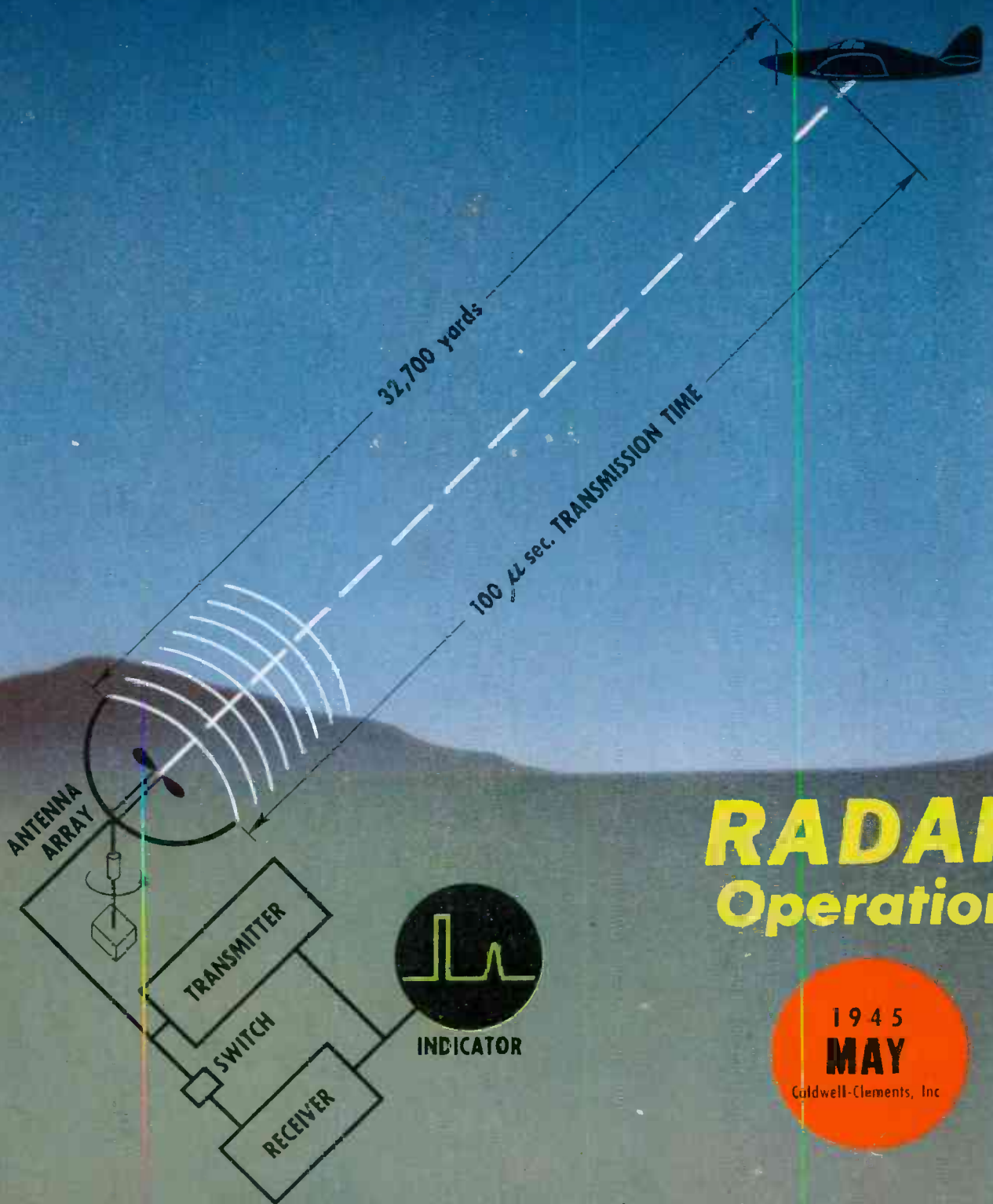

## RADAR Operation

1945  
MAY

Caldwell-Clements, Inc

Dental operating unit with two Mallory Circuit Selector Switches on the front panel as current regulators, and a third Mallory switch at upper right to control the spray bottle warmer.



## More Comfort in Dental Equipment

Thanks to

P. R. MALLORY & CO. Inc.

# MALLORY

## Precision Switches

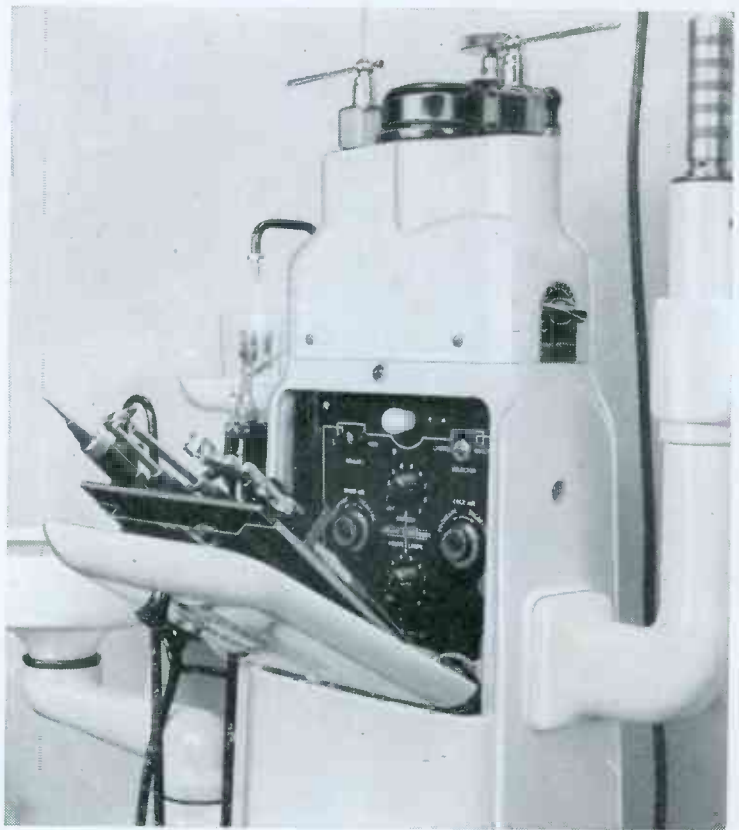

**E**FFICIENT operation of this modern dental unit, built by The Weber Dental Manufacturing Co., Canton, Ohio, is assured by its electronic controls—including three Mallory Circuit Selector Switches, two for regulating current, the third for operating the spray bottle warmer.

While these Mallory switches are *standard* parts . . . available throughout the country from Mallory Distributors . . . they are built to precision tolerances and incorporate such *special* features as: low-resistance, self-cleaning contacts; "hill-and-valley" index for smooth, positive switching action; heavy

insulating sections; notched shafts for easy cutting to desired lengths.

Electronic engineers designing industrial and professional equipment find it a great convenience to specify Mallory Approved Precision Products—multi-gang, single gang and push button switches, resistors, volume controls, jacks and plugs. You can simplify your own procedures . . . from blueprint through assembly line . . . by writing Mallory parts into your circuit diagrams.

Ask your Mallory Distributor for a free copy of the latest Mallory catalog. For engineering help on any specific problem, consult us.

P. R. MALLORY & CO., Inc.  
INDIANAPOLIS 6, INDIANA



P. R. MALLORY & CO. Inc.  
**MALLORY**

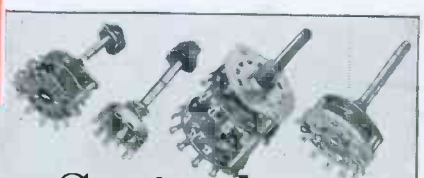

## Industrial and Electronic Switches

# ELECTRONIC INDUSTRIES

Including INDUSTRIAL ELECTRONICS

★ IN THIS ISSUE

MAY, 1945 ★

FRONT COVER—Radar Operating Principles .....	See pages 4 and 76
EDITORIAL .....	75
OPERATIONAL ELEMENTS OF A RADAR SYSTEM .....	76
RAILROAD RADIO .....	81
SIMPLE FM CONVERTERS .....	82
MEETING SPECS IN UHF .....	84
CASE-STUDIES OF TYPICAL ELECTRONIC HEATING JOBS .....	86
TUBE CHARACTERISTICS .....	88
GUN SOUND RANGING .....	89
COLD CATHODE OSCILLOGRAPH .....	90
THERMAL STABILITY IN RECEIVER OSCILLATORS—II .....	93
100-300 MC EQUIPMENT .....	96
REVIEWING SOME BASIC MODULATION PROCESSES .....	98
INTERFERENCE EFFECTS IN FM WITHOUT LIMITING .....	100
PRODUCTION SHORT CUTS .....	104
MAGNETRON FREQUENCIES .....	106
3-BAND "MORALE" SET .....	107
DESIGN OF ELECTRONIC HEATING GENERATORS .....	108
Survey of Wide Reading .....	112
What's New .....	114
Washington News .....	116
Television Today .....	120
Association News .....	122
New Patents Issued .....	126
New Books .....	234
New Bulletins .....	238

ORESTES H. CALDWELL, Editor M. CLEMENTS, Publisher

**EDITORIAL STAFF**—Ralph R. Batcher, consulting editor; Stanley P. McMinn, managing editor; William Moulie, electronic theory and design; H. Gregory Shea, industrial engineering applications; Josepha Zeitner, Ph.D., patents and foreign reviews; H. L. M. Capron, engineering management relations; E. T. Bennett, editorial records; Charles Dreyer, art director; Carl Bührer, circuit diagrams; Roland C. Davies, 1290 National Press Building, Washington, D. C., Washington editor; Arthur H. Halloran, 1020 Union St., San Francisco, west coast editor.

**READER SERVICE**—J. Cosin, H. Mirtel; data research, H. Kullk.

**CIRCULATION**—B. V. Splnetta, circulation director; Subscriptions; list compilation: B. Gollub, M. Groening, B. Ruchalsky.

**BUSINESS**—M. H. Newton, business manager; John Samborn, eastern manager; Richard Fitzpatrick, western manager; O. H. Sutter, New England manager; Lee Robinson, district manager; Ben Morris, research; N. McAllister, production manager; J. E. Cochran, make-up; E. P. Butler; W. W. Swigert, credit manager; W. Kenneth Reynolds, D. Williams, E. Callahan.

**CHICAGO MANAGER**—R. Y. Fitzpatrick. Tel. RAN. 9225. 201 N. Wells Street.

**CALDWELL-CLEMENTS, INC. — TEL. PLAZA 3-1340 — 480 LEXINGTON AVENUE, NEW YORK 17, N. Y.**

Electronic Industries, May, 1945. Vol. IV, No. 5. Regular price per copy 35 cents. Published monthly by Caldwell-Clements, Inc., 480 Lexington Avenue, New York, N. Y. M. Clements, President; Orestes H. Caldwell, Treasurer; M. B. Clements, Assistant Secretary. Subscriptions: United States and possessions, Mexico, Central and South American countries, \$3.00 for one year; \$5.00 for two years; \$6.50 for three years. Canada, \$3.50 per year; \$5.50 for two years; \$7.15 for three years. All other countries \$5.00 a year. Entered as Second Class Matter, September 20, 1943, at the Post Office at New York, N. Y., under the act of March 2, 1879. Copyright by Caldwell-Clements, Inc., 1945. Printed in U. S. A.

Available through Leading Radio Equipment Distributors!



# AMPEREX

## WATER AND AIR COOLED TRANSMITTING AND RECTIFYING TUBES

The more popular AMPEREX tubes are available through leading radio equipment distributors. Thus, engineers may now obtain many of our standard tube types with minimum delay. The AMPEREX line, especially for industrial and electro-medical applications, is probably the most com-

plete in the industry. AMPEREX engineers pioneered in the design and development of these types, and our name stamped on a "bottle" designates longer life with corresponding economy. If we can be of service to you, on present or peacetime assignments, we will be very glad to oblige.

**AMPEREX**

*... the high  
performance  
tube*



## AMPEREX ELECTRONIC CORPORATION

79 WASHINGTON ST., BROOKLYN 1, N. Y. . . . Export Div.: 13 E. 40th St., N. Y. 16, N. Y., Cables: "ARLAB"

WASTEPAPER IS A CRITICAL WAR REQUIREMENT... SAVE EVERY SCRAP



# AWAY AHEAD!

TOBE LEADS IN NOISE ELIMINATION



## NEW SCREEN BOOTH FILTER

**H**ERE is more evidence of Tobe's Leadership in the noise elimination field. This remarkable SCREEN BOOTH FILTER is designed for use in laboratory testing rooms, including those already shielded to prevent outside electrical interference. It is attached to the power line at the point of entrance into the booth, and is designed to eliminate troublesome interference which might upset vital testing work. *Note the exceptional frequency range, from .15 MC to 400 MC.*

### CONTAINER DIMENSIONS

Length . . .	20 1/16"	Height . . .	4 1/8"
Width . . .	7 15/16"	Weight . . .	35 lbs.

Whenever your problem is connected with eliminating electrical interference, the name to remember is

. . . TOBE! We have a great inventory of knowledge on this subject, backed by 17 years' experience. Your inquiries are welcome at any of our offices. Investigate the applications you can make of TOBE Filters, including the unusual SCREEN BOOTH FILTER described on this page.

**TOBE DEUTSCHMANN CORP., CANTON, MASS.**



GRAND CENTRAL TERMINAL BUILDING  
NEW YORK 17, N. Y.  
•  
110 WEST BROADWAY  
GLENDALE 4, CAL.  
•  
230 NORTH MICHIGAN AVE.  
CHICAGO 1, ILL.  
•  
2-159 GENERAL MOTORS BLDG.  
DETROIT 2, MICH.

## THE COVER

The cover illustration, drawn by Electronic Industries' versatile artist, Charles Dreyer, depicts the principle of operation of a radio location installation, otherwise known as a radar transmitter and receiver. The drawing is based on well known principles of radio wave propagation and reflection which have been in use for various purposes for a number of years, as, for example, in the determination of ionosphere heights, the establishment of the absolute altitude at which airplanes fly over unknown terrain and in other ways dependent upon the projection of a beam of high frequency energy and its reception and measurement after reflection from a distant object.

The article which starts on page 76 is one of the first which censorship authorities have permitted to be published on the general subject of radar principles and operation.

### Editorial Awards

To prevent possible misunderstanding, we should like to make plain that ALL papers and articles prepared by anyone other than regular members of the Editorial staff, and published in "Electronic Industries," automatically will be considered for the Editorial Awards originally announced in the March issue. In other words, it is not necessary specifically to designate an article as being intended for consideration under the terms of the Award, listed herewith.

1. An award of \$600 (first prize), \$300 (second prize), \$100 (third prize) will be made by Caldwell-Clements, Inc., for technical papers published in *Electronic Industries* and judged to be most outstanding contributions to the electronic field.
2. All technical papers published in *Electronic Industries*, May, 1945, through December, 1945, inclusive are automatically eligible.
3. All technical papers received by *Electronic Industries* will be handled in the same manner as heretofore. If accepted, and published, the author will receive the usual space rate payment for the article. No special treatment of the paper is necessary to make it eligible for the Caldwell-Clements award.
4. Judges will be outstanding authorities in various electronic fields. Names of judges will be announced before contest closes.
5. Papers will be judged on following points:
  - a) Contribution to the electronic art.
  - b) Originality of thought and application.



★  
CONTRIBUTING  
to  
VICTORY  
and the  
New Electronic World

**MERIT COIL & TRANSFORMER CORP.**

TELEPHONE

4427 North Clark St. Long Beach 6311 CHICAGO 40, ILL.

# G-E high-frequency tubes for electronic heating are **SERVICE PROVED!**



Type GL-889-A (water-cooled) is shown at left; price \$160  
Type GL-889R-A (forced-air-cooled) at right; price \$280

Your tube requirements for electronic heating are best served by G-E power triodes, which have demonstrated their efficiency over years of both radio transmitting and industrial use. Combining modern design and proved trustworthiness which feature the entire line of G-E tubes for electronic heating, Types GL-889-A and GL-889R-A, shown above, contain numerous advancements reflected in superior performance.

- Their compact, low-inductance design makes for stable operation under varying circuit conditions, while individual features of construction add

efficiency and contribute strength.

- Cathode distortion is minimized by multiple-strand design and rigid construction of this electrode. The self-supporting grid cage structure further increases internal stability.

- In all respects Types GL-889-A and GL-889R-A are engineered for top-grade service in busy plants where dependability is a first essential. Consult your nearest G-E office or distributor for further information about G-E high-frequency tubes for electronic heating. Or write direct to *Electronics Department, General Electric, Schenectady 5, N. Y.*

### Characteristics of the GL-889-A

Three-electrode vacuum oscillator tube for producing the high-frequency alternating current required in electronic heating. Its water-cooled anode suits Type GL-889-A for induction heating, where water-cooling generally is employed. Cathode voltage and current are 11 v and 125 amp. Maximum plate ratings are: voltage 8,500 v, current 2 amp; input 16 kw, dissipation 5 kw.

For dielectric heating, Type GL-889R-A is available with cooling by copper-fin radiator and forced air. Ratings are the same as those given above for Type GL-889-A.

Hear the G-E radio programs: "The World Today" news, Monday through Friday, 6:45 p. m., EWT, CBS. "The G-E All-Girl Orchestra," Sunday 10 p. m., EWT, NBC. "The G-E House Party," Monday through Friday, 4 p. m., EWT, CBS.

THERE ARE 265 MAIN SUPPLY OUTLETS FOR G-E ELECTRONIC TUBES, BACKED UP BY CENTRALLY LOCATED STOCKS IN 26 LARGE CITIES FROM COAST TO COAST

# GENERAL ELECTRIC

102-09-8850

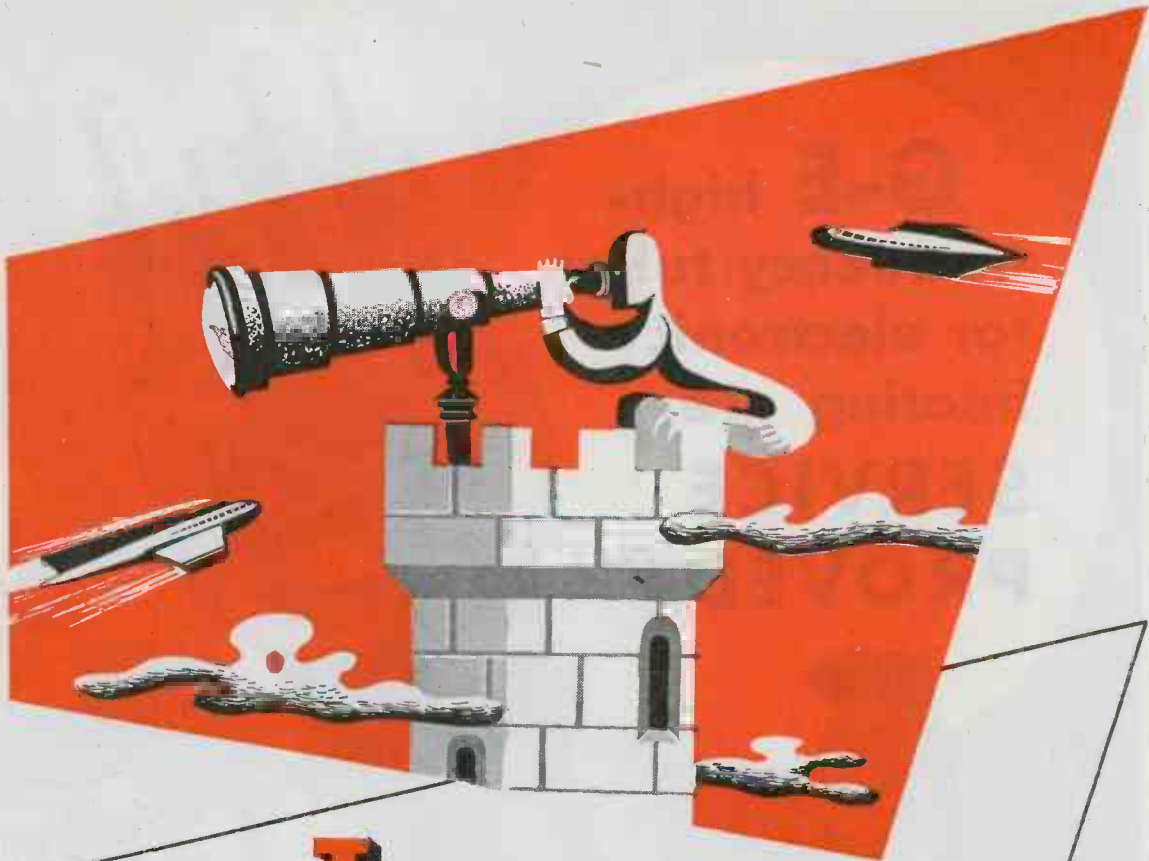

## **I**very tower . . . with a view!

**Aireon** engineers are not in any sense prima donnas. But

we do provide them with the sort of seclusion that promotes constructive thinking...an isolated building of 22,000 square feet, equipped with the latest and finest scientific apparatus, given over exclusively to research and development. A place where you can hear a kitten pound its feet. ■ This partly accounts for the fact that, of twenty-eight *major* electronic products, turned out by our Electronic Division, *twenty-four* were largely designed from the ground up and converted into production realities by **Aireon** engineers. ■ The regenerative force of research is responsible for the steady progress of **Aireon** in the electronics field. Supporting it are manufacturing facilities groomed for the mass production of precision products. ■ Our executives are ready to discuss your plans for today and tomorrow—our engineers and plants to carry them out. A call to any one of our offices will bring results.

# **Aireon**

**MANUFACTURING CORPORATION**

Formerly AIRCRAFT ACCESSORIES CORPORATION

**Radio and Electronics • Engineered Power Controls**

**NEW YORK • CHICAGO • KANSAS CITY • BURBANK**





## Let Trouble be our Introduction

**T**HERE'S nothing like trouble to bring people together. That's how some of Revere's closest friends were gained — through a mutual struggle against difficulties, trouble such as occasionally beset any business.

Take the case of an important electronic product for war use costing several hundred dollars. Rejections were running extremely high, over 40%, costs were skyrocketing, and badly needed production was being lost. The manufacturer asked us if we would care to collaborate in solving the problem. Of course, we would. After studying the subject in detail with the manufacturer's engineers, we suggested a radical change in the properties of a non-ferrous product used in the manufacture of the vital part causing failure. New processes of manufacture were developed and in a short time test runs of the new material proved we were right. Rejections of finished units dropped to less than 1%. Thus a vexing and expensive bottleneck was broken, and we gained a new customer and a firm friend.

This success story demonstrates that Revere has an open mind as well as an informed one, and is always ready to question the customary, find new answers to new problems. If something is worrying you in your employment of non-ferrous materials in electronics, get in touch with Revere, not for ready-made answers, but for wholehearted cooperation, a joint search for better results. This help is given freely, without obligation, through the Revere Technical Advisory Service, which has at its command the knowledge and facilities of our laboratories, and the accumulated experience of the entire Revere organization. Just write the Revere Executive Offices.

# **REVERE**

**COPPER AND BRASS INCORPORATED**

*Founded by Paul Revere in 1801*

*Executive Offices: 230 Park Avenue, New York 17, N.Y.*

# NOW IN FULL PRODUCTION...

## —the new NYT transformer plant at Alpha, New Jersey

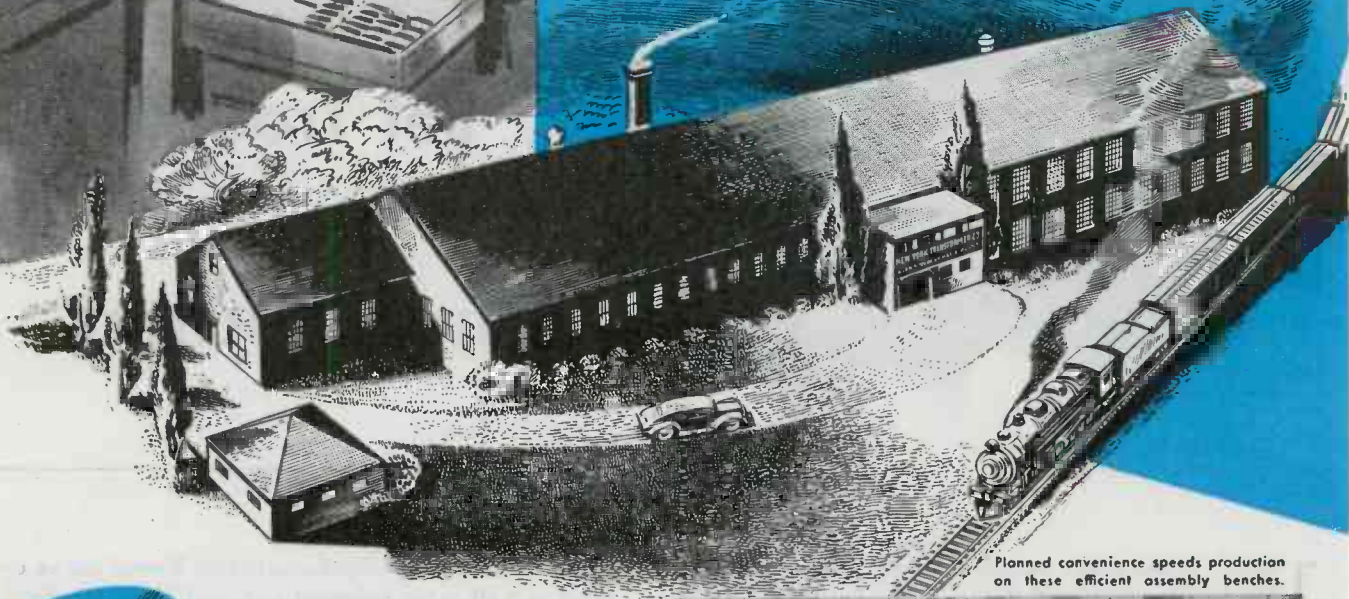

Planned convenience speeds production on these efficient assembly benches.



### **COLLABORATION:**

N-Y-T service to the electronic manufacturer begins at the design stage. The experience of N-Y-T design engineers extends into every field in which transformers are used. These men are at your service.



### **ENGINEERING:**

N-Y-T engineers will meet your requirements at minimum unit cost. They also know how to design transformer components so as to simplify your production assembly and reduce dimensional requirements.



### **MANUFACTURING:**

Highest quality is paramount. Not only electrical characteristics but all materials used in assembly are held to the most exacting requirements. Rigid inspection is imposed at every stage of production.



## THE NAME FOR PRECISION

# ...ready to meet present and post-war transformer requirements!



Complete in every phase of transformer manufacture, the Alpha Division of N-Y-T embraces one of the most modern equipped plants in the East, including complete laboratories, engineering and manufacturing facilities.

This new plant is now at peak production and is rapidly assuming the roll of 'transformer department' to many of the leading manufacturers of electronic equipment.

## NEW YORK TRANSFORMER COMPANY

GENERAL OFFICES

26 WAVERLY PLACE, NEW YORK 3, N. Y.

Ample inventories systematically stocked prevent production delays—assure prompt delivery.

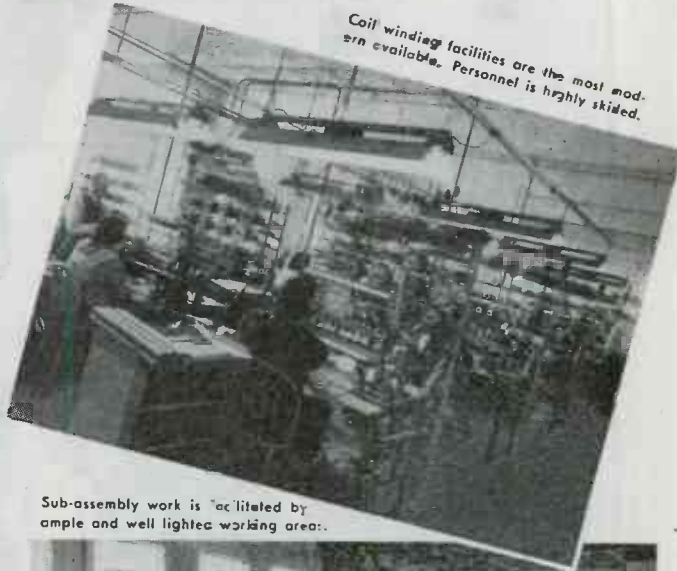

Coil winding facilities are the most modern available. Personnel is highly skilled.

Sub-assembly work is facilitated by ample and well lighted working area.



Units are preheated before potting. Compound is poured slowly to fill every recess.



### TRANSFORMERS, CHOKES AND FILTERS

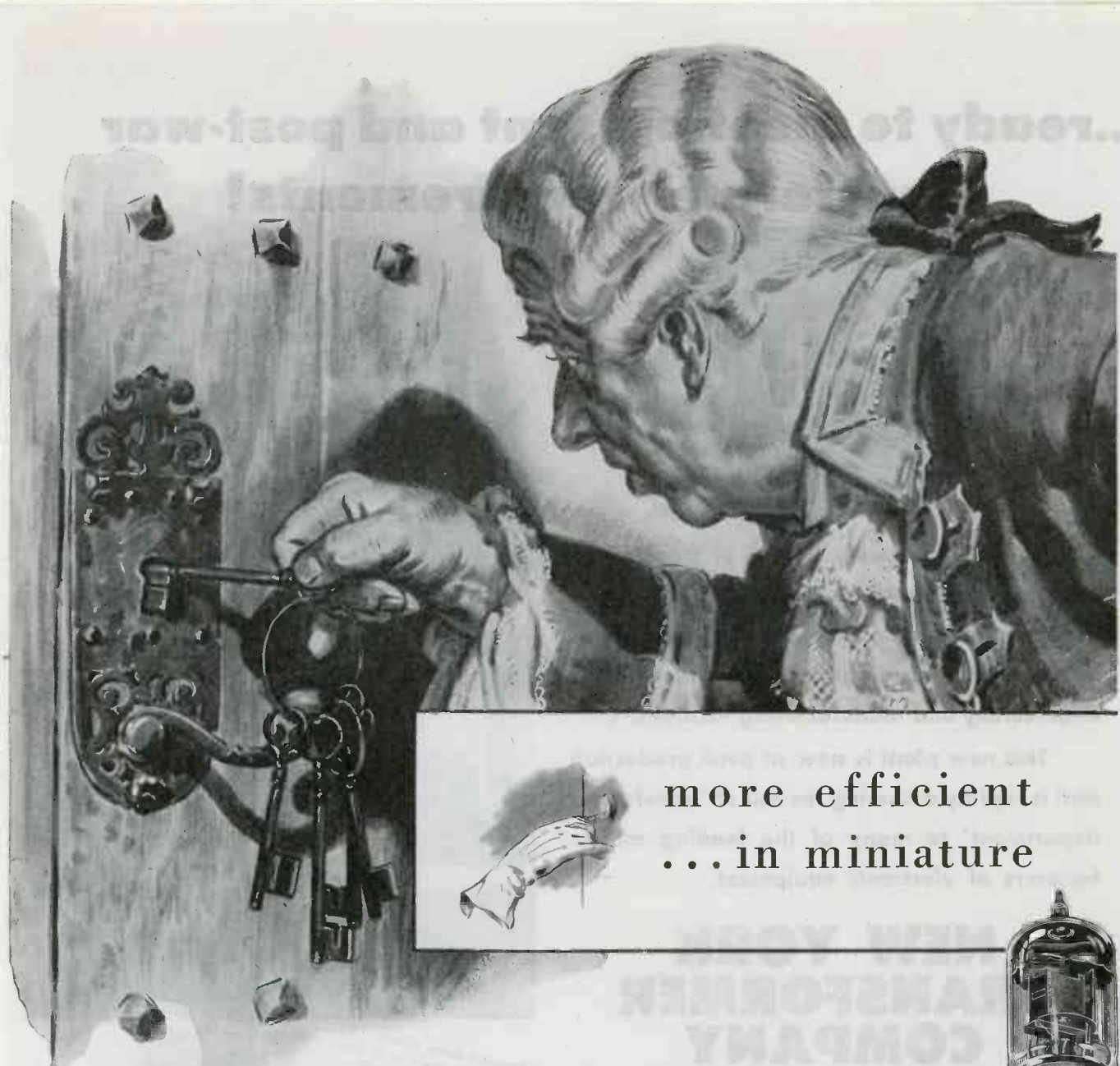

more efficient  
... in miniature

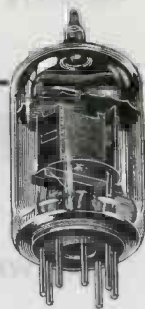

Imagine a lady carrying a bunch of keys for old time locks in her evening bag. Their bulk and weight would make this impractical... yet, for modern locks, it is common practise for her to carry several keys. Imagine trying to crowd a kit of old-style large tubes into the midget receiving set of the future. TUNG-SOL Miniature Electronic Tubes have indeed opened up new possibilities in compactness and weight.

When miniature tubes were introduced, they created much interest... but set manufacturers asked "will they work as well?" The answer is "yes." In most circuits, miniatures do a better job than large tubes. Some high frequency circuits could not even be designed with large tubes. Added advantages of miniatures are their small size and reduced weight.

The experience gained at TUNG-SOL in producing tubes of all kinds for wartime purposes is at the disposal of manufacturers engaged in building more efficient electronic equipment. TUNG-SOL engineers will be glad to aid in the improvement of circuits and in a better selection of tubes. Your future plans will be held in strictest confidence.

**TUNG-SOL**  
*vibration-tested*  
**ELECTRONIC TUBES**

**TUNG-SOL LAMP WORKS INC., NEWARK 4, NEW JERSEY**  
*Also Manufacturers of Miniature Incandescent Lamps, All-Glass Sealed Beam Headlight Lamps and Current Intermittors*

ELECTRONIC INDUSTRIES • May, 1945



**SOLAR**

**CAPACITORS...**



**Trustworthy in every climate**

**SOLAR PRODUCTS**

DRY ELECTROLYTIC CAPACITORS  
WET ELECTROLYTIC CAPACITORS  
PAPER CAPACITORS  
MICA CAPACITORS  
"ELIM-O-STAT" SUPPRESSORS  
CAPACITOR ANALYZERS



**SOLAR MANUFACTURING CORP.**

285 MADISON AVE. • NEW YORK 17, N. Y.

# WEAVING COMMUNICATION HIGHWAYS

**RESEARCH**  
FINDS THE IDEA

**DESIGN**  
GIVES IT FORM

**DEVELOPMENT**  
MAKES IT WORK

**SPECIFICATIONS**  
TELL THE FACTORY

## BELL TELEPHONE LABORATORIES

brings together the efforts of 2000 specialists in telephone and radio communication. Their wartime work has produced more than 1000 projects for the Armed Forces, ranging from carrier telephone systems, packaged for the battle-front, to the electrical gun director which helped shoot down robots above the White Cliffs of Dover. In normal times, Bell Laboratories' work in the Bell System is to insure continuous improvement and economies in telephone service.





## CONCENTRICITY...

### For Uniform Transmission Characteristics in High Frequency Lines

IN COAXIAL CABLES, more than in any other types, accurate relationship between the component parts is essential.

Concentricity and uniformity of conductors and dielectric join in Anaconda Coaxials to effectively fulfill the objectives of electrical designers.

Each type is specifically designed to serve best in the intended application. All electrical characteristics are held within close limits to uniform standards assuring accurate surge impedances.

In addition to manufacturing standard types of coaxial cables, Anaconda offers research and engineering facilities to meet needs for specialized types.

45308



**ANACONDA COAXIAL CABLES**

Anaconda coaxial cables are made in a variety of types to Army-Navy specifications.



# ANACONDA WIRE & CABLE COMPANY

GENERAL OFFICES: 25 Broadway, New York City 4

Subsidiary of Anaconda Copper Mining Company

CHICAGO OFFICE: 20 North Wacker Drive 6 • Sales Offices in Principal Cities

**LOW FREQUENCIES ACCURACY TO 1/1,000th of 1%**

Actual Size

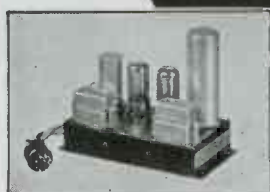

**TOP**  
**FREQUENCY STANDARD**  
(60 cycle) for use with  
external power supply

**CENTER**  
**CHRONOGRAPH**  
Records time intervals  
with resolution to .001 second

**BOTTOM**  
**FREQUENCY STANDARD**  
(120 cycles) with  
self-contained power supply

These tuning forks which include new engineering principles, provide frequencies from 120 to 1,000 cycles directly with an unqualified guarantee of accuracy to 1 part in 100,000 over a wide temperature range. (Better than 1 second in 24 hours). Closer tolerances are obtainable on special order.

These tuning fork assemblies are available only in single or multi-frequency instruments of our own manufacture which are de-

signed to test, measure or control other precision equipment by mechanical, electrical, acoustical or optical means.

The dependability of these frequency standards is being demonstrated for myriad purposes in all climates and under all working conditions.

If you have need for low frequency standards of exceptional accuracy, your inquiries are invited.

**American Time Products, Inc.**

**580 Fifth Ave.**

**New York, N. Y.**

Dist. of Western Electric &  Watch-rate Recorders





"R" IS FOR RELIABILITY

"R" IS FOR RUNZEL

WIRES • CORDS • CABLES



FOR ELECTRONICS...  
RADIO...TELEPHONE...  
Wherever *Quality Wire* Can Serve

**RUNZEL CORD & WIRE CO.**

4723-31 MONTROSE AVENUE • CHICAGO 41

# RECTIFIERS FOR EVERY D-C APPLICATION

## Only G-E Offers

# All 3

Wherever low-voltage power is needed whether for instruments, relays, solenoids, motors, battery charging, plating, or any other d-c application, G.E. can supply the exact size and type rectifier to do the job.

G.E. and only G.E. designs and builds the three types of low-voltage rectifiers most commonly used; copper-oxide, selenium and Tungar. Each rectifier differs in characteristics, basic materials and construction.

The conditions under which a rectifier is to operate and the results that are to be obtained determine which type will do the most economical, most efficient and most satisfactory job.

G-E engineers will gladly analyze your rectifier needs and offer their recommendations. Whether they recommend copper-oxide, selenium or Tungar you can be sure their selection is impartial for G.E. offers all three. For more information write to Section A557-124, Appliance and Merchandise Dept., General Electric Company, Bridgeport, Conn.

### BUY WAR BONDS AND KEEP THEM

Hear the General Electric radio programs: "The G-E All Girl Orchestra" Sunday 10 P.M. EWT, NBC. "The World Today" news every weekday 6:45 P.M. EWT, CBS. "The G-E House Party" Monday through Friday 4:00 P.M. EWT, CBS.

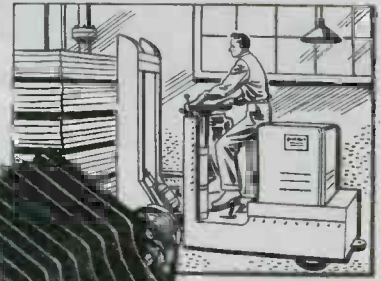

**COPPER-OXIDE**  
Rugged in construction, provides virtually unlimited life when operated within rated capacities.

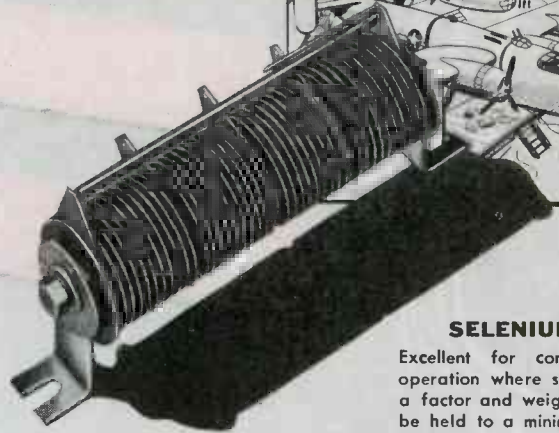
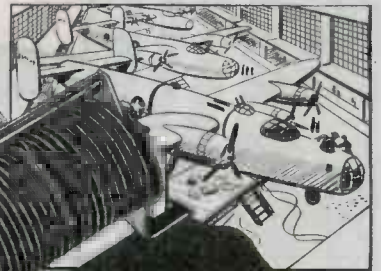

**SELENIUM**  
Excellent for continuous operation where space is a factor and weight must be held to a minimum.



**TUNGAR**  
Efficient and economical for low-voltage applications where life and price are determining factors.

# GENERAL ELECTRIC

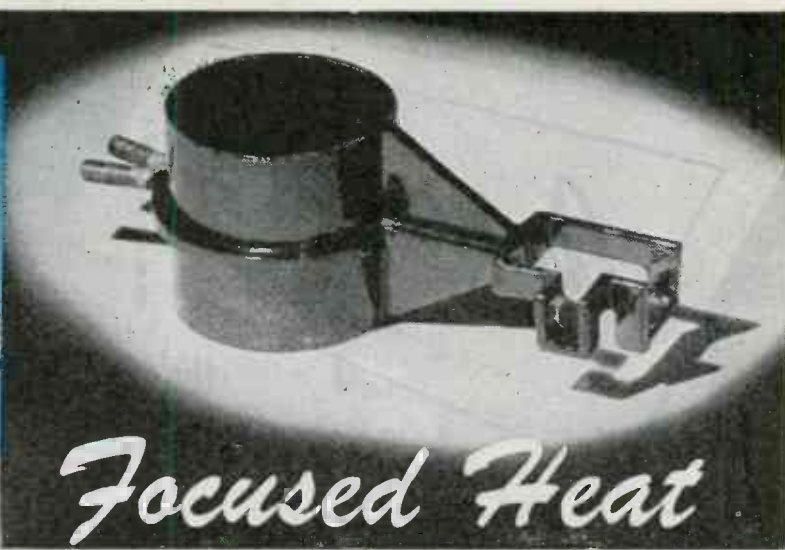
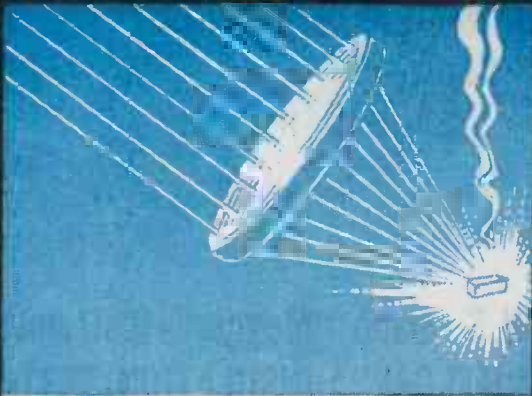

# Focused Heat

## with AJAX-NORTHRUP

The little coil pictured above focuses 6 kilowatts of high-frequency current into a small complicated joint, and produces perfectly brazed bourdon gauge parts at an amazing rate of speed — at low unit heating cost, with no distortion and no clean-up required.

Aptly named a focus inductor, the coil was designed by Ajax-Northrup engineers to control and accurately concentrate the heat — no need to heat the whole part just to braze one small joint.

This particular coil may not fit your work, but suitable inductors or furnaces can be designed to do your production heating jobs with higher speed and quality. By simply changing inexpensive coils and jigs, you can do several operations with the same Ajax-Northrup equipment.



**HARDENING**



**BRAZING**



**FORGING**

## AJAX-NORTHRUP Engineering

For over a quarter of a century Ajax-Northrup engineers have successfully solved hundreds of heating problems with focused high-frequency heat.

We may already have solved problems similar to yours. Call on the full weight of our experience to help you revolutionize your production heating and melting for war now and for peace later.

# A J A X - N O R T H R U P H I G H - F R E Q U E N C Y

AJAX ELECTROTHERMIC CORPORATION • Ajax Park

ASSOCIATE COMPANIES . . . THE AJAX METAL COMPANY. Non-Ferrous Ingot Metals.  
 AMI ELECTRIC FURNACE CORPORATION. Ajax-Wyatt, Induction Furnaces.  
 AJAX ELECTRIC COMPANY, INC. Ajax-Multgren Salt Bath Furnaces.  
 AJAX ENGINEERING CORPORATION. Aluminum Melting Furnaces.



SINCE 1916

# HEATING TRENTON 5, N. J. MELTING

Announcing—

the SECOND U.S.-made "Megger" Instrument  
... THE MIDGET "MEGGER"\* INSULATION TESTER

Following the production, in June 1943, of the first U. S.-made "Megger" testers, we now announce a second "Megger" instrument being built in our Philadelphia factory—the Midget "Megger" Insulation Tester.

This new U. S. model is identical in design and similar in every way to the Midget "Megger" Insulation Testers we have been supplying for the past ten years, except that the molded plastic housing is mottled brown instead of red.

The Midget "Megger" Tester has achieved wide popularity because of its size and low cost. Weighing

but 3 pounds, it is always ready to use for testing insulation resistance of a wide variety of electrical equipment. It is indispensable for maintenance and trouble shooting, even where higher range "Megger" testers can be used . . . reads up to 50 megohms and delivers 500 volts d-c from a hand-cranked generator, making it independent of batteries or external power supply. Lower ratings are also available.

Manufacturing facilities are complete and our expanding production makes availability of these new instruments far better than we have previously been able to offer. We invite your orders for them.

**JAMES G. BIDDLE CO.**

1211-13 ARCH STREET • PHILADELPHIA 7, PA.



For complete description of the new U. S.-made Midget "Megger" Tester, write for Bulletin 1785-EI.

\*By special arrangement with the original makers of the "Megger" Testing Sets, our new instrument carries the U. S. Registered Trade Mark "MEGGER."

INCREDIBLY SMALL...  
INCREDIBLY EFFICIENT...

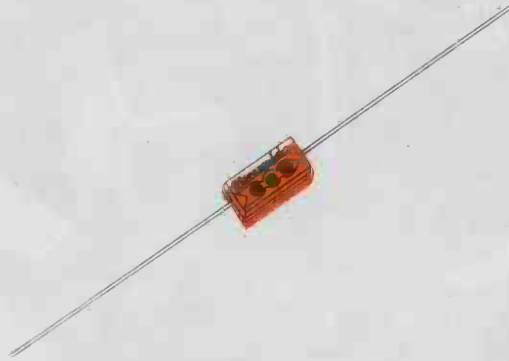

PQ

(Illustrated actual size)

Micamold

*Silvered Mica*  
**CAPACITORS**

The smallest yet—especially notable  
for their remarkable electrical qualities

Another MICAMOLD achievement that dovetails perfectly into advanced Radio and Radar design . . . admirably serving your need for a fine small capacitor to use in TUNED CIRCUITS, such as small IF transformers, tank circuits, etc.

Capacity Range : 5 mf. to 100 mmf.\*  
Voltage Rating : 300 VDC Working 600 VDC Test  
Tolerance : Plus or minus 5% or 1 mmf.—whichever is greater  
Minimum Q : Over 2000  
Temperature Coefficient : Plus or minus 100 parts/million\*\*  
Capacitance Drift : Plus or minus 0.3%\*\*

Molded in Red XM262 (lowloss materia)  
Tropicalized by application of an  
anti-fungus wax

\*PQ is so small, it can only be marked with a  
3-dot color code indicating capacity in mmfs.

\*\*These figures correspond to characteristic "D"  
of specifications JAN - C-5.

*Available At Once*

SAMPLES OR PRODUCTION QUANTITIES

**MICAMOLD** Radio Corporation  
115 Knickerbocker Ave., Brooklyn 6, N. Y.

The Brush Surface Analyzer is used in the precision manufacture of Packard Marine engines that power the PT boats of the U.S. and allied Navies. Photo courtesy of The Packard Motor Car Co.

# Now! NO PRIORITIES

are necessary to purchase a Brush Surface Analyzer  
...Approximately two week delivery on unrated  
orders.

**THE BRUSH SURFACE ANALYZER**  
measures and records the irregularities as shallow  
as a millionth of an inch on steel...glass...  
plastics...plated and painted surfaces.

Ask for a demonstration at your plant.

*An Illustrated brochure, SURFACE  
FINISH—.000001", sent on request*

**THE BRUSH DEVELOPMENT COMPANY**

3433 PERKINS AVENUE

CLEVELAND 14, OHIO

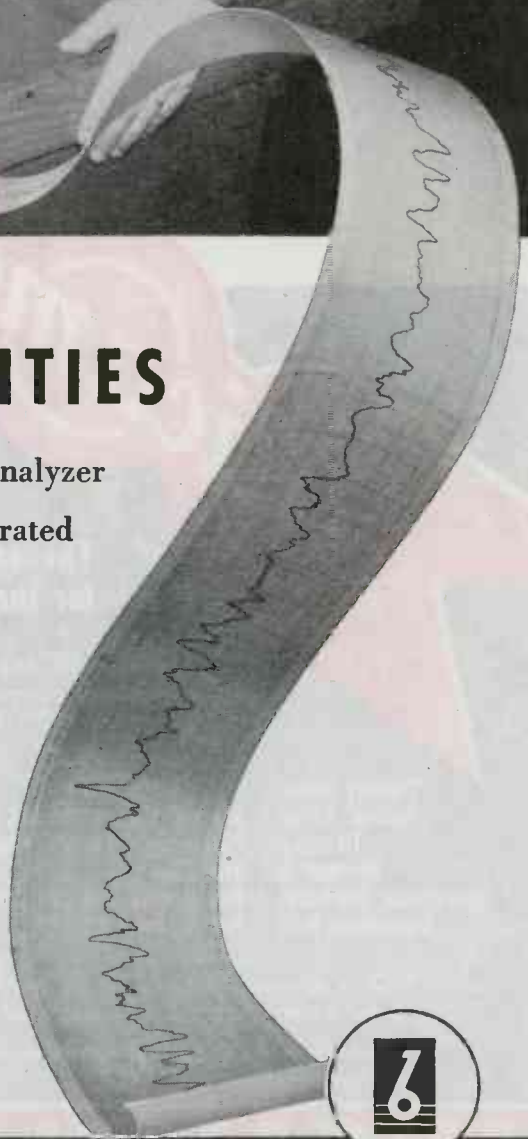



**QUICK  
AS A  
WINK!**



Model 1200 for D. C. operation—Quick action available with contact ratings up to 10 amps. Either quick or time delay action, normally open or closed.

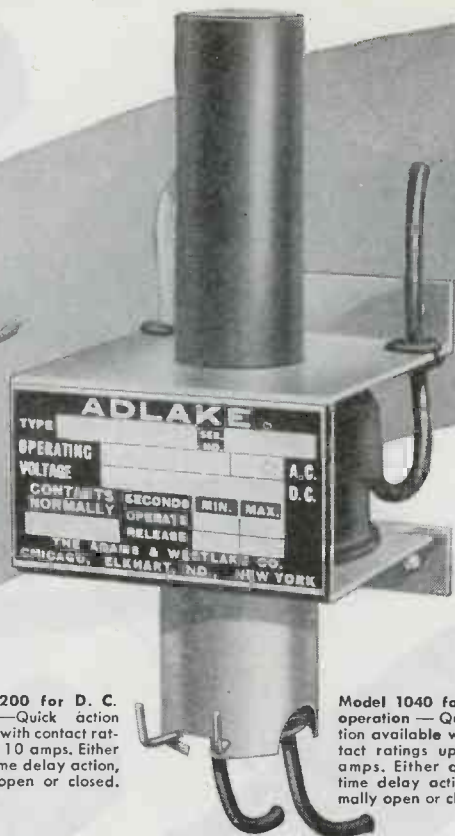

Model 1040 for A. C. operation—Quick action available with contact ratings up to 50 amps. Either quick or time delay action, normally open or closed.

## Circuit Control with ADLAKE MERCURY RELAYS

### HOW THEY WORK

**ENERGIZED**—Coil C pulls plunger P down into mercury M. Mercury thus displaced enters thimble T through orifice O. Inert gas in thimble gradually escapes through ceramic plug CP, thus producing time delay.

**ENERGIZED**—Mercury now fills thimble T, is completely leveled off and mercury-to-mercury contact established between electrodes E and EE. Degree of porosity of ceramic plug CP determines length of time delay.

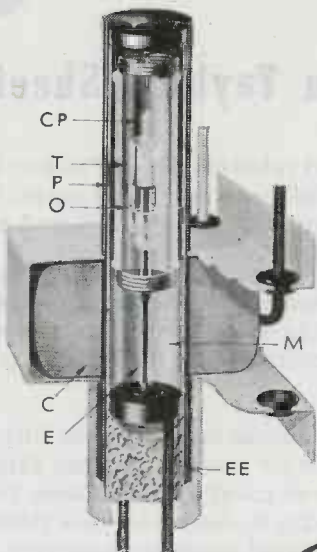

Contacts and break-offs are as quick as a wink because Adlake Plunger-type Relays (models for A.C. or D.C.) use fast-moving, liquid metal mercury . . . positive in action; silent and chatterless; will not burn, pit, or stick.

Under the most exacting conditions . . . heat or cold, dirt, dust, or moisture they're ready and prompt to perform. Mechanisms, encased in armored glass or metal cylinders and then hermetically sealed, are impervious to the elements and oxidation.

No cleaning, no inspection, no servicing . . . relax and let an Adlake Mercury Relay work your timing, load, or control circuits—automatically and trouble-free.

Our bulletin tells the complete story, write for it today.



# THE ADAMS & WESTLAKE COMPANY

ESTABLISHED IN 1857

ELKHART, INDIANA

NEW YORK · CHICAGO

MANUFACTURERS OF ADLAKE HERMETICALLY SEALED MERCURY RELAYS FOR TIMING, LOAD AND CONTROL CIRCUITS

ELECTRONIC INDUSTRIES • May, 1945

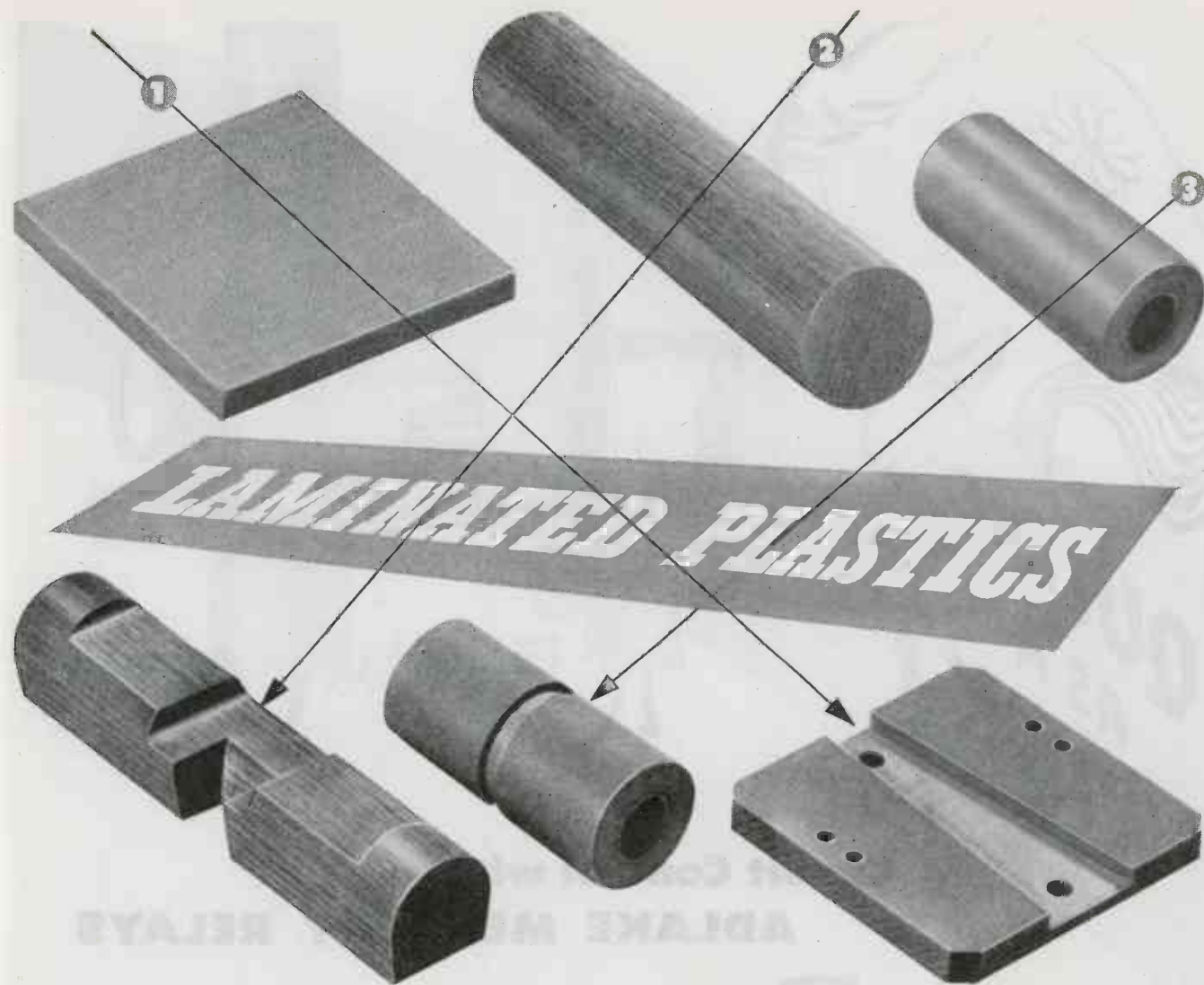

## Thousands of Fabricated Parts from Taylor's Sheets, Rods, Tubes

① One of several parts for an artificial leg, which is sawed, milled and drilled from a flat sheet of Phenol Fibre.

② Hinge support blocks for the P-51 Mustang fighter planes' elevator trim tabs were created and designed by Taylor engineers.

③ Switch spacers, made from tubes of Phenol Fibre, are quickly and accurately finished on a Taylor automatic screw machine.

From sheets, rods, and tubes of Phenol Fibre or Vulcanized Fibre, Taylor makes thousands of different fabricated parts, turning them out by the millions and doing it quickly, accurately, and economically.

Almost every one of these parts is specially designed for a special purpose and calls for a laminated plastic with special characteristics. Their common feature is light weight with great strength. In addition, they have insulating, electrical, and dielectrical properties unequalled by any other material.

Having been in this business for more than fifty years, Taylor also has a stock of standard tools for turning out such things as plain washers, and shoulder bushings, in so many different sizes that the chances are good that the size *you* need is in stock and your fabricated part can therefore be made more quickly and more inexpensively.

Whatever your problem, our engineers will gladly tell you, without obligation, exactly what Taylor Laminated Plastics can contribute to its solution. Write us today, sending sketch or blueprint.

# TAYLOR FIBRE COMPANY

LAMINATED PLASTICS: PHENOL FIBRE • VULCANIZED FIBRE • Sheets, Rods, Tubes, and Fabricated Parts

NORRISTOWN, PENNSYLVANIA • OFFICES IN PRINCIPAL CITIES • PACIFIC COAST HEADQUARTERS: 544 S. SAN PEDRO ST., LOS ANGELES 13



★ *This New Cetron High  
Current Thyatron brings  
New Efficiency to  
Industrial Operations*

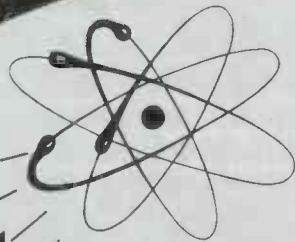

## CETRON CE-304

In the Cetron CE-304 tube shown here, Continental Electric Company engineers have reached a new high in concentrating super-efficiency in the smallest possible space.

CE-304 is a mercury vapor filled tube with a peak current rating of 125 amperes and an average current rating of 12.5 amperes DC. This high current thyatron-type tube is designed to be particularly useful in welding control and motor control applications.

CE-304 uses industrial type 4-pin base; is sturdily constructed. Patented filament design gives exceptionally high output with minimum of cathode power.

CE-304 is built to give long life in all sorts of industrial and other applications where dependability is an important consideration.

*Write for Bulletin No. 119*

**CONTINENTAL ELECTRIC CO.**  
GENEVA, ILLINOIS

CHICAGO: 903 MERCHANDISE MART  
NEW YORK: 265 WEST 14th STREET



# CERAMIC DIELECTRIC TUBES *to Specifications*



Laboratory control — an important factor in the production of Stupakoff quality ceramics.



## *... Assured by* **STUPAKOFF**

Control—from raw material to finished product—assures uniform characteristics in all Stupakoff ceramic dielectric tubes.

Dimensionally accurate, these tubes are produced to meet your specifications for power factor—dielectric constant—temperature coefficient—dielectric strength—volume resistivity. Employ them with confidence in the manufacture of temperature compensating capacitors for reducing frequency drift in RF circuits, for by-pass, lead-through, and blocking.

Stupakoff manufactures a wide variety of ceramic dielectric materials. Tubes—special or standard—are available in temperature coefficients from +120 to -750 parts per million per degree centigrade, depending upon the specific characteristics required. Manufacturing facilities permit prompt delivery in large quantity. Samples upon request.

★  
BUY EXTRA  
WAR BONDS

★



**STUPAKOFF CERAMIC AND MANUFACTURING CO., LATROBE, PA.**

*Ceramics for the World of Electronics*





## Many Armed Servant

The many arms of the FEDERAL organization are the arms of a versatile servant . . . making war goods now and preparing for the new and greater demands of a world at peace.

\* \* \*

For example, FEDERAL INSTRUMENT LANDING AND RADIO RANGE equipment is pioneering new concepts of faster, safer air travel.

FEDERAL'S MEGATHERM dielectric and heat induction units are revolutionizing production processes in the plastics, metal, food, plywood, textile and other industries.

FEDERAL always *has* made better tubes. Today, as the result of continuous scientific development, FEDERAL'S TRANSMITTING, RECTIFYING AND INDUSTRIAL POWER TUBES are proving even more dependable and long lasting.

To fill a vital war need, FEDERAL developed INTELIN ULTRA HIGH FREQUENCY TRANSMISSION LINE — now is the world's largest manufacturer.

FEDERAL'S MARINE RADIO EQUIPMENT, first in serving America's merchant fleet, includes DIRECTION FINDERS, AUTO ALARMS, packaged TRANS-

MITTING AND RECEIVING UNITS and LIFEBOAT TRANSMITTERS.

Back of every FEDERAL TRANSMITTER are years of engineering and manufacturing experience which assure the ability to produce any type or power of communications equipment from walkie-talkie to 200 K.W. transmitters.

QUARTZ CRYSTALS, precision cut and mass produced at FEDERAL, are performing many secret military jobs.

SELENIUM RECTIFIERS, introduced by FEDERAL, are accepted as standard for converting alternating to direct current. Power equipment and battery chargers, powered by FEDERAL SELENIUM RECTIFIERS, are known for long life, high efficiency and low cost.

\* \* \*

Yes, FEDERAL's many arms make many things — all to one high standard. Here some of the world's keenest scientific minds combine their talents with three decades of FEDERAL leadership for developing and producing better communications and industrial electronic equipment.

**Federal Telephone and Radio Corporation**

Newark 1, N. J.





## WHY WE MEASURE OUR OWN "YARDSTICKS"

Complex, sensitive instruments are a commonplace not only in the engineering laboratories but on the production lines of Connecticut Telephone & Electric Division. These instruments enable us to maintain the extreme precision in telephone equipment and electronic devices called for by Signal Corps standards. So important is this high precision that we

have special apparatus for measuring the accuracy of the test instruments themselves.

The result of this constant testing and retesting is *better products*... better telephones, headsets, switchboards and other devices, for our armed forces, a better, brighter future for your communicating systems, electrical and electronic equipment for tomorrow.

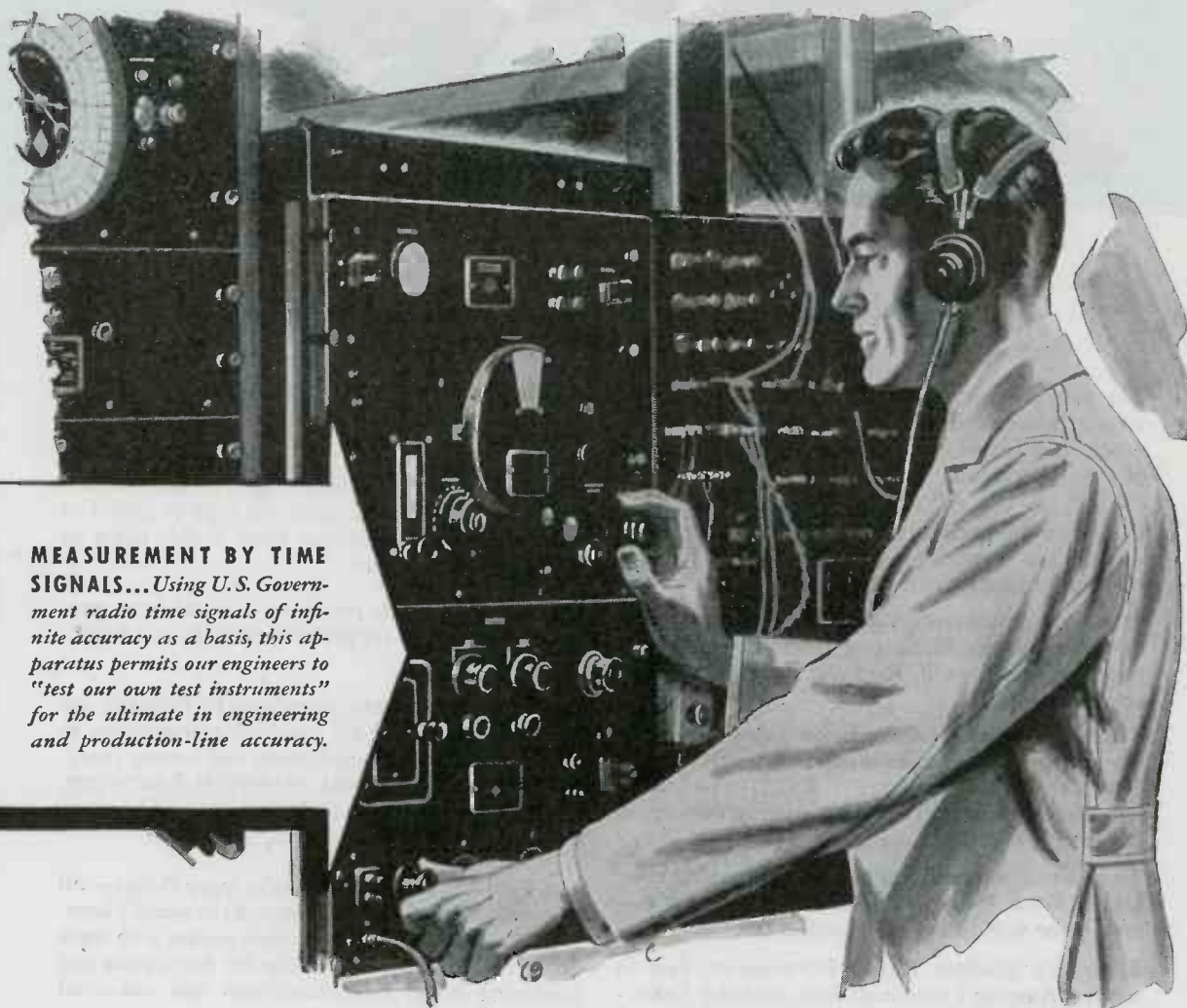

**MEASUREMENT BY TIME SIGNALS...** Using U. S. Government radio time signals of infinite accuracy as a basis, this apparatus permits our engineers to "test our own test instruments" for the ultimate in engineering and production-line accuracy.



## CONNECTICUT TELEPHONE & ELECTRIC DIVISION

GREAT AMERICAN INDUSTRIES, INC. • MERIDEN, CONNECTICUT

TELEPHONIC SYSTEMS • SIGNALLING EQUIPMENT • ELECTRICAL EQUIPMENT • HOSPITAL AND SCHOOL COMMUNICATIONS AND SIGNALLING SYSTEMS • IGNITION SYSTEMS



# Pursuit of a molecule

**ANOTHER  
MACHLETT  
TECHNIQUE**

A stable high vacuum is essential to the production of an electron tube if it is to give uniform, predictable performance. But there is much more to the process of getting a vacuum than just pumping.

Molecules of gas are not only present within the space inside the tube, and inside the metal parts, but also adhere tenaciously to all inner surfaces, or are "adsorbed". There is a special Machlett technique for dislodging those molecules. During pumping both the glass and the metal are brought to high temperatures. Cathode and anode are heated alternately many times, in order to capture molecules that are driven from one surface to the other. Most important of all, the tube is actually operated at voltages far in excess of values generally used in the vacuum tube field. All this takes many hours, the use of perfected apparatus

including Machlett-designed pumps and other equipment, and the highest skills of laboratory-trained technicians.

Thus when the tube is finally sealed we know the heat of operation cannot free enough molecules to affect its performance in your hands. This Machlett technique was developed for our X-ray tubes, and was in part responsible for the Machlett reputation. When we began the manufacture of radio and industrial oscillators, amplifiers and rectifiers, the same methods of capturing the molecules were adopted. That is one of the many reasons why users of Machlett radio and industrial tubes join with medical and industrial users of Machlett X-ray tubes in praising their reliability and economy. It will pay you to buy Machlett tubes. For information as to available types, write Machlett Laboratories, Inc., Springdale, Conn.



*ML-889-R, a rugged forced-air-cooled triode, designed for h-f broadcast and dielectric heating applications*

# MACHLETT

APPLIES TO RADIO AND INDUSTRIAL USES  
ITS **48** YEARS OF ELECTRON-TUBE EXPERIENCE

# Centralab

## Medium Duty Power Switches

- 7½ amp. 115 V. 60 cycle A. C.
- Voltage breakdown 2500 V to ground D. C.
- Solid silver contacts
- 25,000 cycles of operation without contact failure
- Fixed stops to limit rotation
- 20° indexing

Centralab medium duty power switches are now available for transmitters (has been used up to 20 megacycles) power supply converters and for certain industrial and electronic uses.

It is indicated in applications where the average Selector Switch is not of sufficient accuracy or power rating. Its accuracy of contact is gained by a square shaft, sleeve fit rotor, and individually aligned and adjusted contacts. It is assembled in multiple gangs with shorting or non-shorting contacts. Torque can be adjusted to suit individual requirements. Furnished in 1 pole . . . 2 to 17 positions (with 18th position continuous rotation with 18th position as "off"); and 2 or 3 pole . . . 2 to 6 position including "off".



# Centralab

Division of GLOBE-UNION INC., Milwaukee

PRODUCERS OF Variable Resistors • Selector Switches • Ceramic Capacitors • Fixed and Variable • Steatite Insulators and Silver Mica Capacitors



# Beyond the horizon

## The Television Dream That Cables Make Possible

**T**ELEVISION—sign and symbol of the age to come—is one of the wonders that specially designed cable transmission makes practical. For the quality and fidelity of the transmitted image depend largely on how well the cables are engineered and manufactured, from tiny cables in the broadcasting mechanism itself to the great coaxial cables linking city with city, making possible the television networks of the future.

Thus the "wireless age" as it develops will actually need more wires—and more complicated cables—to achieve its realization! And in the solution of these problems, new and more complicated cables will be required.

Today, we will undertake to engineer and manufacture the radio and audio cable requirements of

any government agency or private concern in war work. Moreover, we look forward to solving many of the most difficult cable tasks in peacetime—as we have in wartime. The same laboratories, the same Yankee ingenuity that have helped to whip many of the difficulties involved in the communications requirements of our Army and Navy are prepared to function for industry—whatever the problems of today and tomorrow.

### *Why ANKOSEAL solves cable problems*

Ankoseal, a thermoplastic insulation, can help solve many electrical engineering problems, now and in the future. *Polyvinyl* Ankoseal possesses notable flame-retarding and oil resisting characteristics; is highly resistant to acids, alkalis, sunlight, moisture, and most solvents. Polyethylene Ankoseal is outstanding for its low dielectric loss in high-frequency transmission. Both have many uses, particularly in the radio and audio fields. Ankoseal cables are the result of extensive laboratory research at Ansonia—the same laboratories apply engineering technique in the solution of cable problems of all types.

## THE ANSONIA ELECTRICAL COMPANY

*Specializing in "Ankoseal" a Thermoplastic Insulation*

ANSONIA • CONNECTICUT



*A Wholly-Owned Subsidiary of*

## NOMA ELECTRIC CORPORATION

GENERAL OFFICES • NEW YORK, N. Y.

—In peacetime makers of the famous Noma Lights—the greatest name in decorative lighting. Now, manufacturers of fixed mica dielectric capacitors and other radio, radar and electronic equipment.

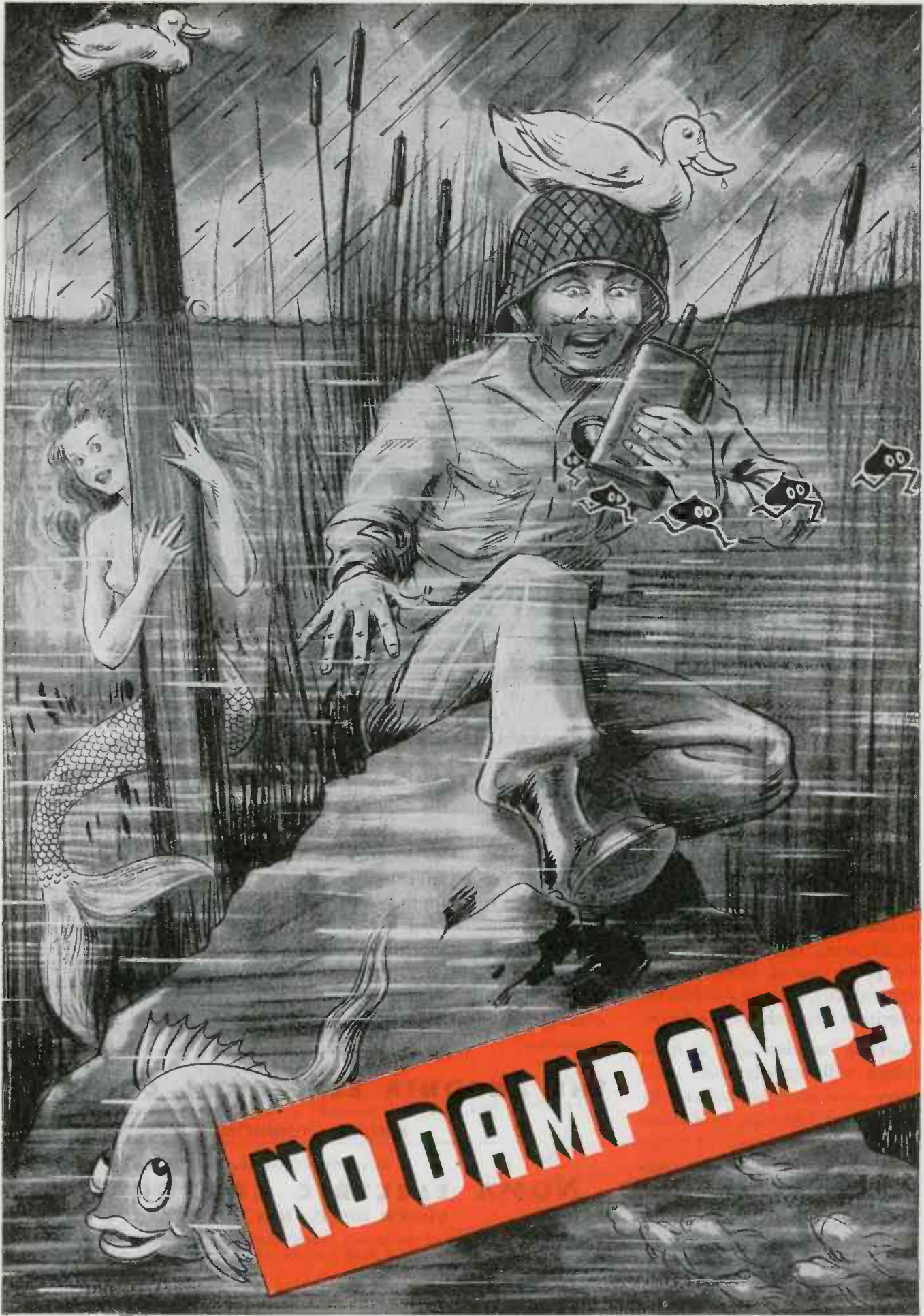

**NO DAMP AMPS**





No. 100

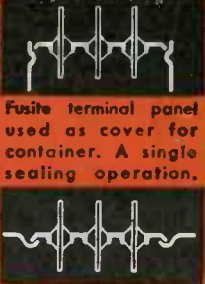



Fusite terminal panel used as cover for container. A single sealing operation.

Hole punched and adapter socket formed to receive Fusite terminal panel.

<b>No. 100</b> SINGLE FLANGE DIAMETER 5/16" (App.)	<b>700</b> SERIES 1" DIAMETER 1.9521	<b>900</b> SERIES 1 1/4" DIAMETER 1.2351
--	--	--

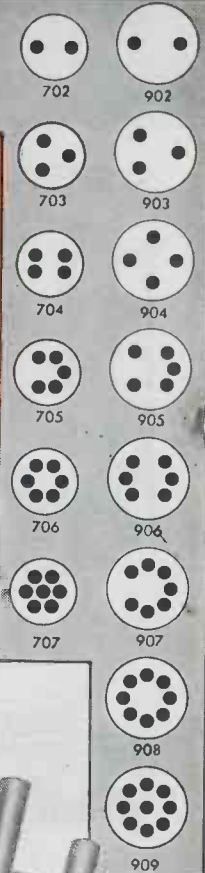
INSERTS IN  
3/16" HOLE



**DUCKING . . .** the issue is old stuff. A good ducking can spell *finis* for electronic equipment. When moisture wades in, the best transformer, coil, relay fold up. Protect them with **FUSITE** Hermetic Terminals. **FUSITE** keeps out the wet and seals in the dry. No damp amps are the positive result, regardless of outside atmospheric conditions. Time, place and temperature can be discounted. This means dependable performance. **FUSITES** pass the tough thermal shock test of dry ice to boiling water. They withstand production handling in your plant and manhandling on the job. **FUSITE** is an inorganic-insulated, hermetic terminal interfused within a reinforced metal shape, all in one piece. One and only one sealing operation is required to provide a perfect hermetic seal. **FUSITE** saves parts and labor, downs costs, ups production and helps to guarantee the performance of your electronic component parts. Look for this mark  stamped in every seal. It is your guarantee of "proved performance." Write for samples on your business letterhead.



No. 908

GLASS TO METAL

**WITH  
FUSITE  
SEALS**



A "GI" AMP,  
OUT ON A PRANK,  
IS GOOD FOR NOTHING-REALLY!  
WET MAKES HIM HIGH,  
SO KEEP HIM DRY,  
"MP"-WITH **FUSITE SEALING!**

**CINCINNATI ELECTRIC  
PRODUCTS COMPANY**

CARTHAGE AT HANNAFORD, NORWOOD,  
CINCINNATI 12, OHIO

Copyright 1945, Cincinnati Electric Products Co.

**FUSITE**  
**HERMETIC TERMINALS**  
**NO DAMP AMPS!**

# RHEOSTATS

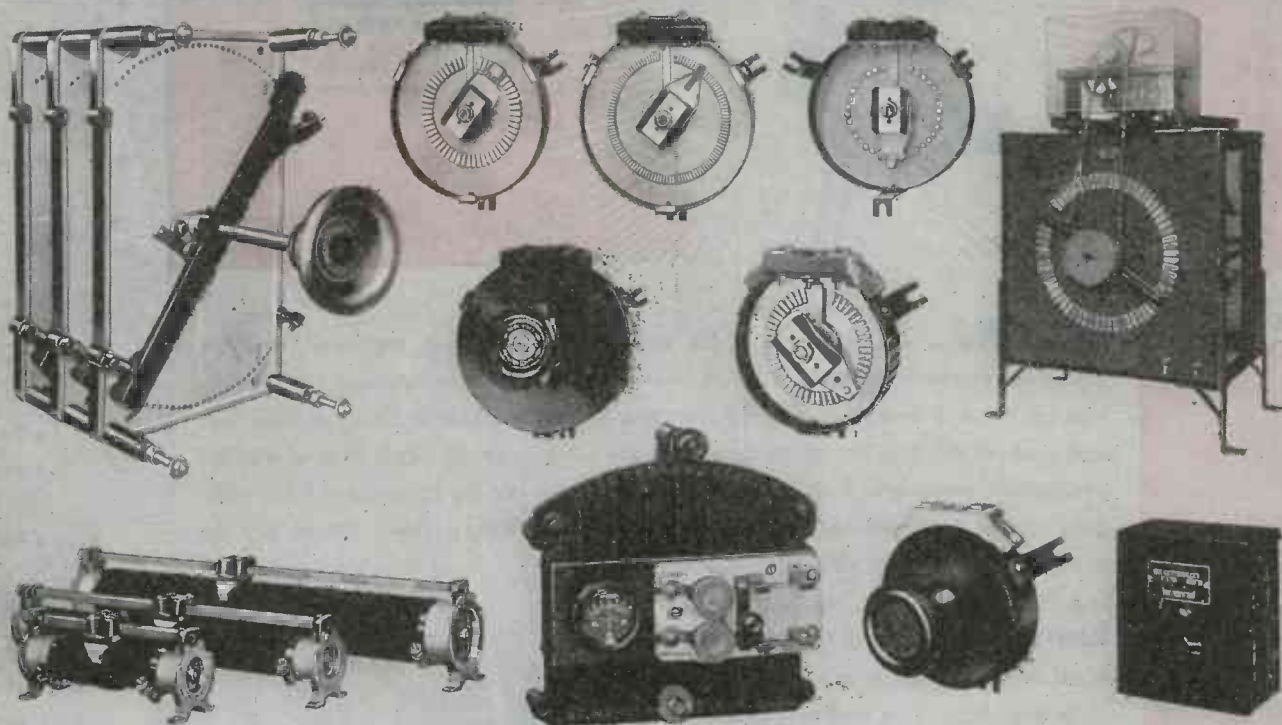

The Ward Leonard line of rheostats includes the widest range of sizes, tapers and current ratings from the tiny types for radio to huge multiple assemblies for the heaviest industrial use. Smooth operation, durable contacts and extreme dependability characterize all Ward Leonard Rheostats, Resistors and Relays. Write for bulletins of interest to you.

## WARD LEONARD

### RELAYS • RESISTORS • RHEOSTATS



Electric control  devices since 1892.

WARD LEONARD ELECTRIC COMPANY • 61 SOUTH ST. • MOUNT VERNON, N. Y.

ELECTRONIC INDUSTRIES • May, 1945

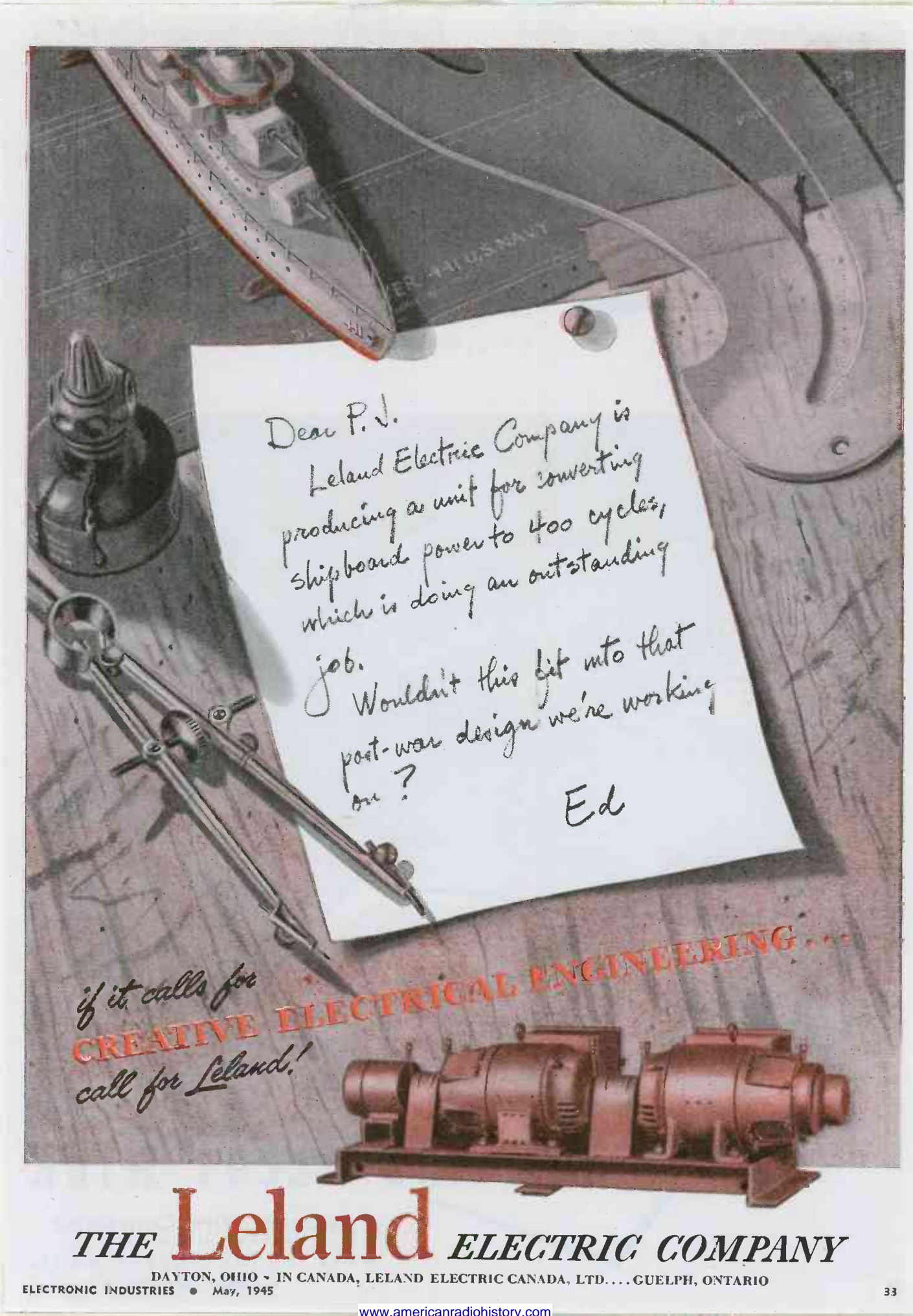

Dear P. J.

Leland Electric Company is producing a unit for converting shipboard power to 400 cycles, which is doing an outstanding job.

Wouldn't this fit into that post-war design we're working on?

Ed

*if it calls for  
call for Leland!*

**CREATIVE ELECTRICAL ENGINEERING...**

**THE Leland ELECTRIC COMPANY**

DAYTON, OHIO • IN CANADA, LELAND ELECTRIC CANADA, LTD. . . . GUELPH, ONTARIO

ELECTRONIC INDUSTRIES • May, 1945

"Try this on your

**BIG GUNS!"**



Crouching in an old shell hole on shore, a fire control party directs a battleship's deadly salvos against enemy strong points holding up Allied invasion forces. On the world's far-flung fighting fronts, battle-tested Spencer precision wire used in communication equipment is hastening the day of final Victory.



PHOTO U.S. SIGNAL CORPS.

**SPENCER**  
*Precision*  
**WIRE**



**FINE STEEL AND ALLOY WIRE**

Spencer Wire Company  
WEST BROOKFIELD PLANT  
WEST BROOKFIELD • MASS.  
ELECTRONIC INDUSTRIES • May, 1945

# "CLIENT WILL BUY A BUSINESS"

If some of your War activities cannot be continued profitably in Peacetime, then perhaps a client of ours\* can help you.

Our client wishes to buy a going business or a complete department of a permanent organization.

This is to help them in the rapid expansion of a growing concern whose success is due to Electrical and Electronic Engineering talent, backed by proven merchandising ability.

Anything that can be made and sold to any branch of Electrical Communications will interest them; this includes Radio, Telephone, Telegraph, Television, Radar, Wire Photo, Sound on Film, Wire or Disc. An accessory widely used in these fields would be ideal.

Also, any items that would carry their technical ability into Industrial markets or into Air, Ground or Marine Transportation would be attractive.

They are particularly interested in products with protected positions either by virtue of patents, special "know-how" or limited markets; however, they would be glad to consider situations relating to mass markets.

They prefer products whose quality demands Engineering and Manufacturing skill thereby justifying above average sales prices and careful selling attention.

If you will be forced to stop work on any of your projects after V-day, either because they are out of line with your Peacetime activities or because they have insufficient sales volume to be of interest, then our client would like to meet you.

They would like to study your situation with reference to their ability to take over one of your projects, either now or later, and continue it on a mutually profitable basis.

All answers will be held confidential. Please reply to:

*Cory Snow, Inc.*

• MERCHANDISING • ADVERTISING •  
739 BOYLSTON ST. BOSTON 16, MASS.

*\*We are authorized to furnish the name of our  
client if requested on your business letterhead.*



**FRANKLY, SMITHERS, YOUR DIRECTORS DON'T NEED TO SEARCH THE SCRAP PILE,  
ALBION CAN SHIP ALL THE COILS YOU NEED!**

**SUPER-QUALITY COILS AT REASONABLE PRICES**

More and more every day, the industry is turning to Albion for fast, quality and quantity production of coils, chokes, and transformers. That's because here you benefit from the unbeatable combination of management "know how," skilled workmanship, streamlined facilities, and central location. Your requirements will be given prompt and thoughtful attention.

**ALBION  
COIL COMPANY**

ALBION, ILLINOIS

R. F. AND TRANSMITTING COILS AND CHOKES;  
I. F. TRANSFORMERS

# creative capacitor engineering



CJD TYPE 6K MEDIUM POWER MICA CAPACITOR

Ideal for high stability tuned circuits where constant capacity is required. A compensated unit which can be made having any temperature coefficient between the limits of  $+0.003\%$  to  $-0.005\%$  per degree C. (tolerance  $\pm 0.001\%$  per degree C) over a temperature range from  $-40^{\circ}$  C to  $+70^{\circ}$  C, made in a wide range of capacity and voltage ratings.

# CORNELL-DUBILIER CAPACITORS

1910 1945



MICA • DYKANOL • PAPER • WET AND DRY ELECTROLYTICS

The name Cornell-Dubilier on capacitors is more than a 35-year old symbol of dependability.

It stands for creative capacitor engineering—the technical ingenuity capable of designing and building peak-efficiency capacitors for every application. C-D's engineering ability acknowledged today, was already recognized when Secretary of the Navy, Josephus Daniels, wrote on March 8, 1919:

"Mr. Dubilier's improved condenser has been of value in increasing the compactness and reliability of radio transmitters."

William Dubilier, pioneer of modern capacitors, set a high precedent for Cornell-Dubilier engineers.

Today, he works with them—counsels them with the wisdom of a lifetime devoted to capacitor engineering. He has inspired them to further creative efforts.

The result: Basic innovations in capacitor design, engineering and manufacture—such as the first series-stack mica capacitor.

*We welcome the opportunity to demonstrate to you our ability to design and build any type capacitor for your needs. Cornell-Dubilier Electric Corporation, South Plainfield, N. J. Other Plants: New Bedford, Brookline, Worcester, Mass. and Providence, R. I.*



# YOURS!

*Just write us, on your letterhead, for your copy of this valuable booklet on permanent magnets*

● As a service to industry, The Arnold Engineering Company is "lending a hand" in the distribution of what Arnold engineers believe to be a very informative study on the subject of permanent magnets.

This 39-page book of permanent magnet theory, design data and references was published by the government. Arnold is pleased to make it available to you free of charge and without obligation. Write for it today!

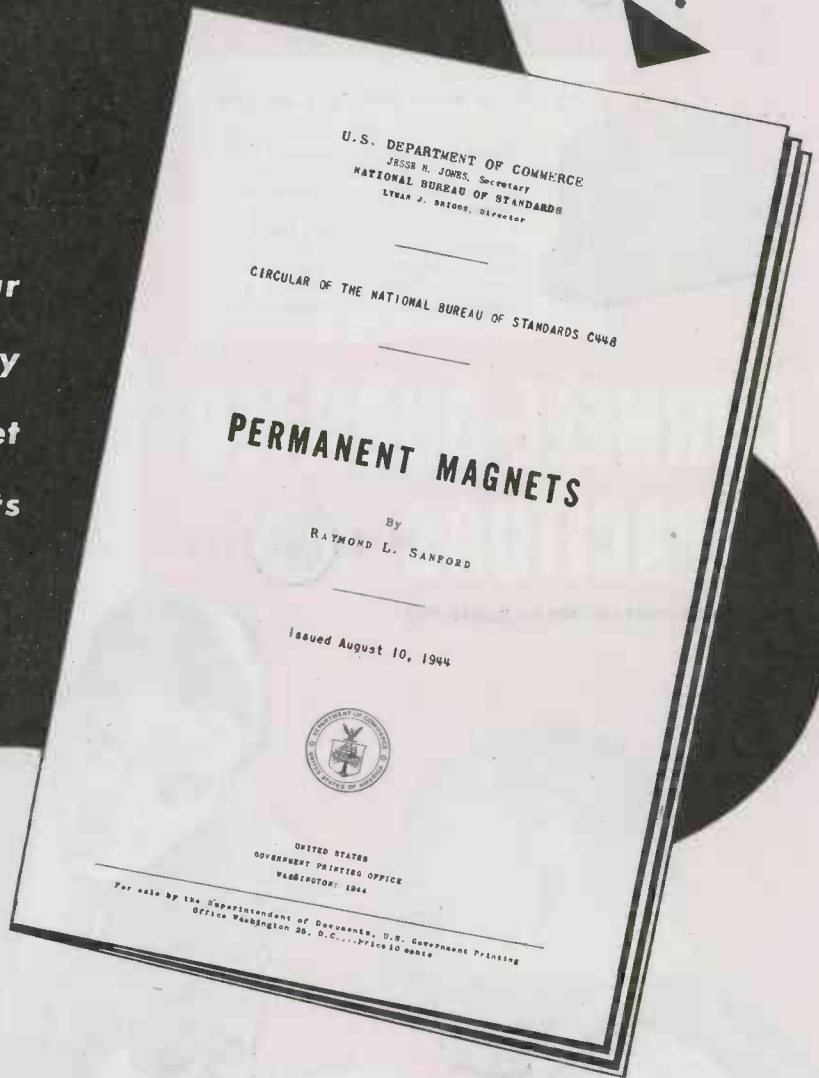

## THE ARNOLD ENGINEERING COMPANY

147 EAST ONTARIO STREET, CHICAGO 11, ILLINOIS

*Specialists in the Manufacture of ALNICO PERMANENT MAGNETS*





## Out of the War Came **BETTER** Insulation!

**S**TRIKING progress in many lines during the all out war effort will have great value in the future and will pay back a part of the terrible cost of war.

Formica FF and MF grades developed during this time have introduced glass base laminated sheets to electrical engineers and have provided insulation of a new high quality in the laminated form.

Some of these grades are excellent high frequency insulators—comparable with ceramics—yet they maintain the easy machinability and workability of laminated parts. They can be punched, drilled, milled. Some of them have exceptional heat resistance for use in motor slot wedges and similar applications.

They will produce better electrical devices at lower costs in the years to come, and contribute in a small way to making a better world.

Engineering data on request.

**THE FORMICA INSULATION COMPANY**  
 4647 Spring Grove Avenue  
 Cincinnati 32, Ohio



548	594	569	551	592
552	535	540	525	503
557	504	508	533	

# IMAGINE SPOT WELDING with a PAIR of TWEEZERS!



**NEW BESCO SPOT WELDING TWEEZERS** are already performing successfully for some of America's leading radio tube manufacturers . . . uniting fine wires .003" OD and larger . . . as fast as 4,000 welds an hour . . . getting in and out of the tightest spots by virtue of their fine tips . . . leaving behind perfectly welded elements, free of oxidation, ready to meet rigid inspection standards.

No skill is required to use the TWEEZERS. They are held with bare hands . . . comfortably . . . without danger to the operator. The plastic covered, copper leads are flexible, permitting the TWEEZERS to be used in any position. Standard leads are 18"; longer leads are available as required. Maintenance is cut to a minimum; the points require "touching up" only once a day.

To operate: connect the lugs in place of the regular welding electrodes on your present welding equipment and use with a timer which cuts the current and times the length of the weld. Applications are unlimited; they may be used on any small, precise parts which require fine spot welding.

Cost is amazingly low . . . only \$15.00 per dozen units. Estimated life . . . from four to six months. Sample units are available for immediate delivery at \$1.25. Check with your welding department NOW; place your order at once. This ingenious, new invention may revolutionize your entire welding procedure to your everlasting benefit.

When writing ask for catalog data on complete line of Tweezers for fine assembly work of all kinds.

**PLACE YOUR ORDER NOW FOR NEW BESCO SPOT WELDING TWEEZERS**

Please send One Dozen Tweezers @ \$15.00 (check here)  
Please send Sample Pair Tweezers @ \$1.25 (check here)  
Please quote on Tweezers with leads of \_\_\_\_\_ quantity  
(Please write for additional information on your own letterhead, include request for catalog of tweezers for fine assembly work.)

FIRM NAME \_\_\_\_\_

PER \_\_\_\_\_

ADDRESS \_\_\_\_\_

MRO PREFERENCE RATING AND CERTIFICATION REQUIRED

**NEW JERSEY JEWELERS' SUPPLY** • 280 Plane Street, Newark 2, N. J.  
MANUFACTURERS



NEW



**SPOT WELDING**

**TWEEZERS**

- PROBES FOR, BENDS, HOLDS, WELDS SMALL PARTS
- CONNECTS TO PRESENT SPOT WELDING EQUIPMENT
- REACHES ALMOST INACCESSIBLE ELEMENTS
- OPERATES ON FROM 1/2 TO 1 KVA ON 10 AMP CURRENT
- NO SKILL REQUIRED
- MINIMUM MAINTENANCE
- FAST, PRODUCTIVE, INEXPENSIVE
- NO OXIDATION, CLEAN WELD
- WELDS COPPER, NICKEL, STEEL, TIN, TIN ALLOYS, BRASS, MONEL, ZINC, BRONZE, NICKEL TO TUNGSTEN, COPPER TO NICKEL

\*PAT. PENDING

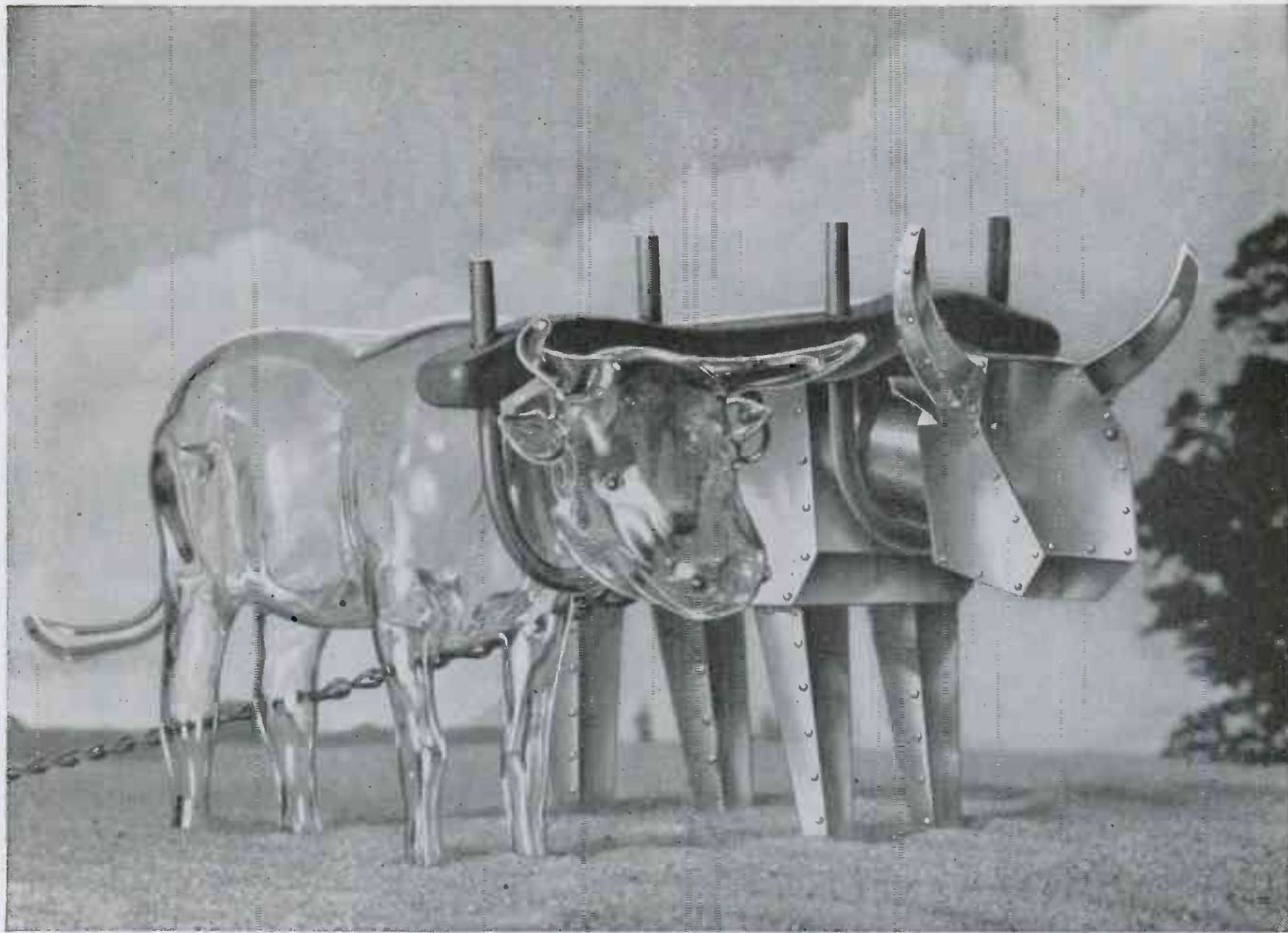

## TOGETHER THEY FORM A GREAT TEAM...

*thanks to Corning Metalizing!*

**G**LASS and metal work together for the electronics industry under a yoke fashioned by Corning Research in Glass.

Metalized glass has been used for many years, mainly for decorative purposes. But Corning Research developed a metalizing process which can be accurately controlled and which is permanent under severe industrial service conditions.

The superior electrical properties of glass are well known in the electronics field. Low power factor, high dielectric strength, extremely high resistance, wide range of dielectric constants—

coupled with fine mechanical properties—make glass invaluable in electronic applications. The addition of metalized areas permits hermetic seals between glass and metal by ordinary soldering methods. Corning's metalizing process, particularly when applied to low expansion glasses, also produces accurate and fixed inductances, capacitances or shielding.

Perhaps our team of glass and metal can help you. Write us about your problem. Address Electronic Sales Department I-5, Bulb and Tubing Division, Corning Glass Works, Corning, N. Y.

**CORNING**  
— means —  
Research in Glass

*Electronic Glassware*



"PYREX", "VYCOR" and "CORNING" are registered trade-marks and indicate manufacture by Corning Glass Works, Corning, N. Y.

# OHMITE RESISTORS

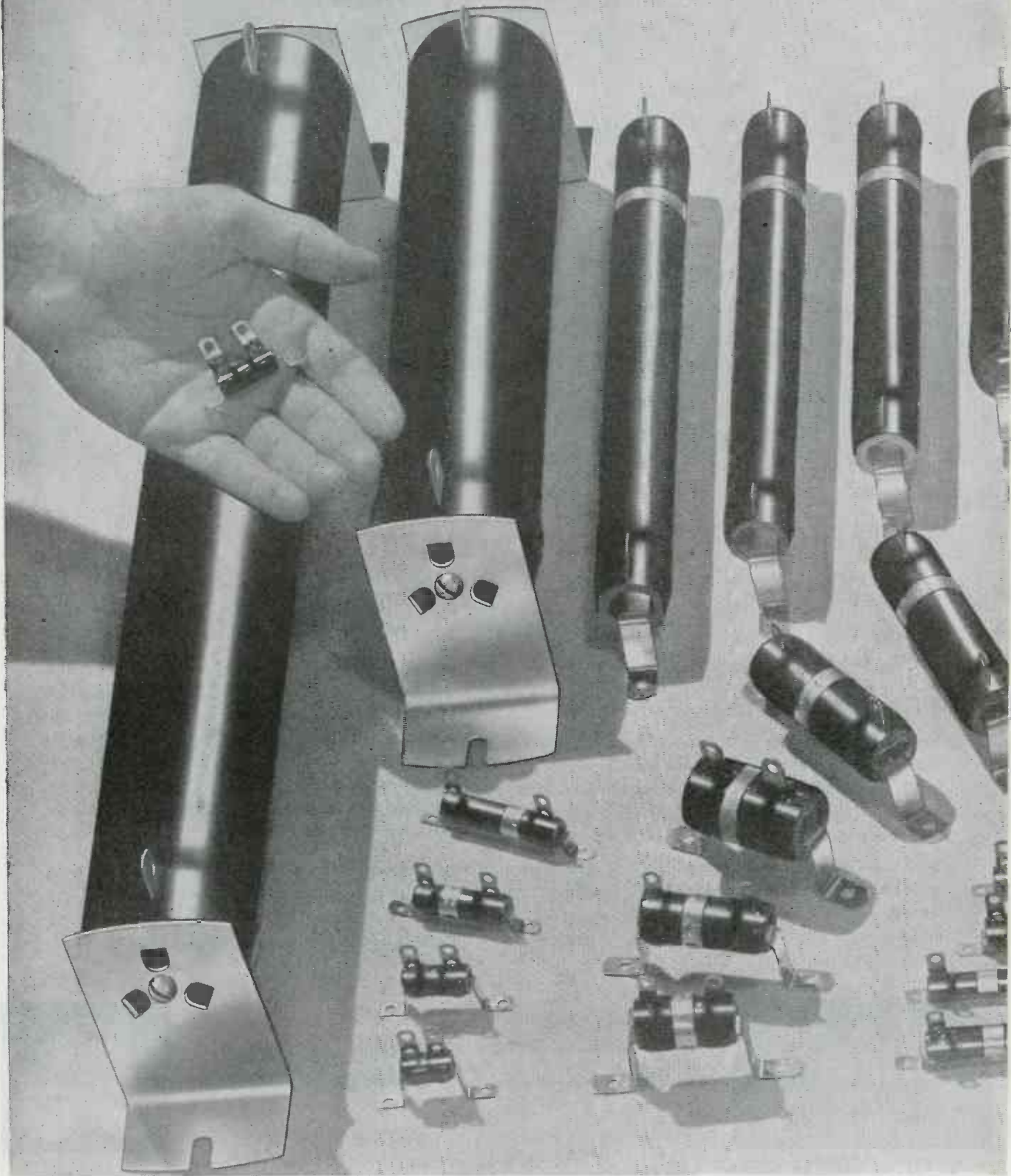

# More than 60 Core Sizes to Meet Every Control Need

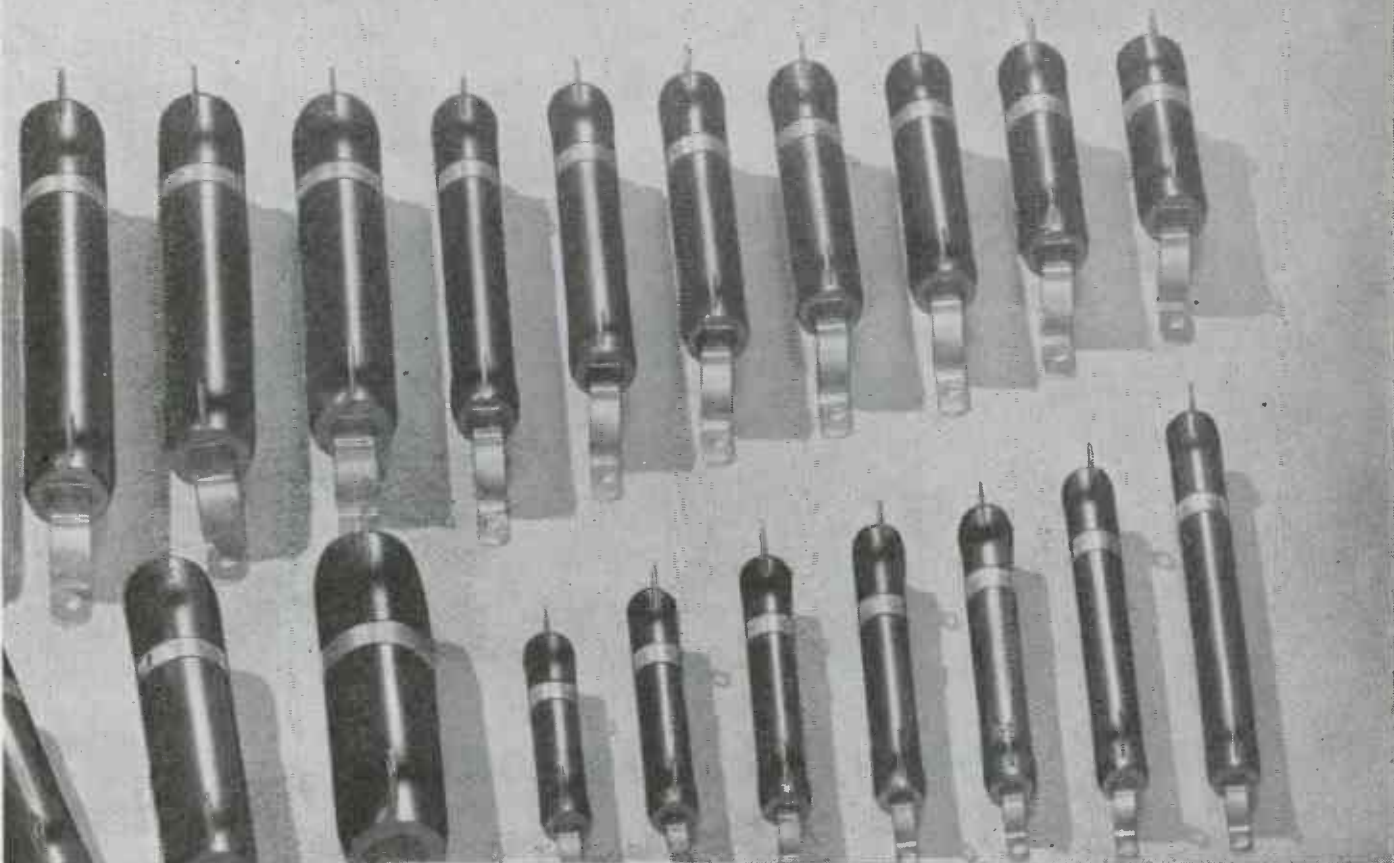

Large resistors. Small resistors. Stock units. Made-to-order units. You get the exact size and type you need at Ohmite, to solve your particular problem. More than 60 different core sizes . . . as large as  $2\frac{1}{2}$ " diameter by 20" long . . . as small as  $\frac{5}{16}$ " diameter by 1" long. Where required, special sizes can be produced. Terminals, mountings, enclosures are available for all types of applications.

Ohmite quality is time-proved. These

rugged resistors serve in all types of critical equipment for war, industry, research and communications. They give trouble-free resistance control under extremes of temperature, humidity, shock, vibration, altitude. Experienced Ohmite engineers are at your service always.

Write on company letterhead for Industrial Catalog and Engineering Manual No. 40.

**OHMITE MANUFACTURING CO.**  
4983 Flournoy St., Chicago 44, U.S.A.



Be Right with **OHMITE**  
RHEOSTATS • RESISTORS • TAP SWITCHES

# "Here's how Courtney checks up on Courtney!"

*Alan Courtney*



## "...via a PRESTO recorder"

"An announcer must check up on his technique constantly," says Alan Courtney, popular announcer of WOY's *1280 Club* program. "My own way of doing this is to make frequent recordings of my voice on a portable PRESTO recorder. Then, by listening to the records, I can get an idea of how I sound to the radio audience. Naturally, the accuracy of the recording is of the utmost importance. I find a PRESTO recorder

ideal for the work, because, even in amateur hands, it produces cuttings of uniformly high fidelity and clarity."

PRESTO sound recording and transcription equipment is used by major broadcasting companies, in industry, in schools and colleges, and by the Armed Forces. Every PRESTO unit, from the largest to the smallest, is a product of high engineering skill and uncompromising manufacturing standards. Write for information.

**WORLD'S LARGEST MANUFACTURER  
OF INSTANTANEOUS SOUND  
RECORDING EQUIPMENT  
AND DISCS**

# PRESTO

**RECORDING CORPORATION**

242 West 55th Street, New York 19, N. Y.

*Walter P. Downs Ltd., in Canada*

ELECTRONIC INDUSTRIES • May, 1945

# COMPACT!

NO. 6 IN THE NEW IRC PRODUCT LINE

## IRC'S NEW FINGERTIP CONTROL ANSWERS SPACE-SAVING PROBLEMS

No bigger 'round than a nickel and wafer thin, this new Fingertip Control will find many important applications in miniature electronic devices. An all-inclusive unit, its unique design eliminates the usual bulky knob, shaft and bushing without any impairment of functional operation.

Of neat appearance and available in either black or colors, this Type H control is intended for edgewise installation. A light-pressure, fingertip rotation of the knurled edge of the cover permits ready resistance adjustment.

Embodying suitable mechanical strength and many of IRC's famous features as found in Type CS and D controls, the Fingertip Control has a rotation of 290°, a power rating of 0.25 watts and 500 ohms to 3 megohms, as standard resistance values. Fingertip Control may be had with linear taper or with standard audio tapers.

Inquiries are invited from interested manufacturers of hearing aids and other miniature equipment. Engineering Bulletin on the Type H control is now in preparation.

**OCCUPIES LESS THAN HALF CUBIC SPACE REQUIRED FOR CONVENTIONAL TYPES**

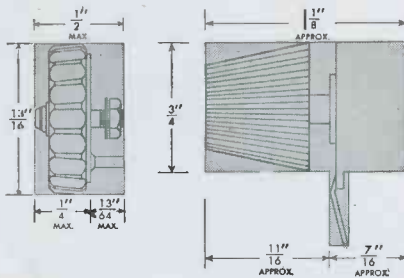

# INTERNATIONAL RESISTANCE CO.

DEPT. 2-E

401 NORTH BROAD STREET • PHILADELPHIA 8, PA.



IRC makes more types of resistance units, in more shapes, for more applications than any other manufacturer in the world.



AN 3455  
Rheostat



BTR—1/4 watt  
Insulated Resistor



BTA—1 watt  
Insulated Resistor



Grade 1—Class 1  
Resistors



Type FRW  
Resistor



Fingertip  
Control

COMING...COMING..



# SLIDE RULES

## A TRADITION OF SKILL AND PRECISION

Never before have so many K & E Slide Rules been wanted by engineers for such critically important work.

You may have had to wait for the K & E Slide Rule you wanted. We apologize. We've stepped up our wartime production tremendously. But in the manufacture of Slide Rules haste can be a hazard. The engineer cannot tolerate instrumental errors in his equipment.

K & E Slide Rules are traveling all over the world. They have to stand up to all kinds of climates and conditions. Only carefully selected materials, experienced skill and thorough workmanship are sure to do that.

That's why engineers know they can rely on the unvarying accuracy of a K & E Slide Rule anywhere, anytime.

You will find Don Herold's booklet, "How to Choose a Slide Rule" helpful and amusing. Write to Keuffel & Esser Co., Hoboken, N. J.



*Drafting, Reproduction, Surveying  
Equipment and Materials.  
Slide Rules. Measuring Tapes.*

**KEUFFEL & ESSER CO.**

EST. 1867

NEW YORK • HOBOKEN, N. J.

CHICAGO • ST. LOUIS • DETROIT • SAN FRANCISCO  
LOS ANGELES • MONTREAL



# HERMASEAL

## HERMETICALLY SEALED TRANSFORMERS —DEPENDABLE IN JUNGLE WARFARE



U. S. MARINE CORPS PHOTO

AmerTran has always adhered rigidly to high quality standards. For this reason, Hermaseal Hermetically Sealed Transformers had no difficulty in meeting the strict requirements of government procurement officers for "tropicalization" of these components.

Precautions include vacuum varnish impregnation of core and coil, infra-red pre-heating before compound filling, induction soldering of case seams. Ceramic terminals are protected by torque gauging and resilient gaskets. To insure thorough hermetic sealing, each unit is subjected to a vacuum immersion test. Write for details.



**HERMASEAL**

THE AMERICAN TRANSFORMER CO., 178 Emmet St., Newark 5, N. J.

Pioneer Manufacturers of Transformers, Reactors and Rectifiers for Electronics and Power Transmission

### AMERTRAN ASSIGNED "APPROVED" QUALITY CONTROL RATING BY AIR FORCES

On March 14, 1945, the Air Technical Service Command of the Army Air Forces delegated to the American Transformer Company full responsibility for meeting contract requirements. This assignment of an "Approved" Quality Control Rating which eliminates duplicate inspection during fabrication was awarded on the basis of AmerTran's record in adhering to quality standards.

# AMERTRAN

MANUFACTURING SINCE 1907 AT NEWARK, N. J.

*Attention*  
EQUIPMENT  
MANUFACTURERS

# HEINTZ and KAUFMAN takes the lead in solving a problem which has plagued the equipment designer

Heintz and Kaufman is establishing a standardization policy which will be heartily welcomed by all who design and service electronic equipment.

From now on, whenever you engineer your equipment around Gammatron tubes you can be sure that *identical* replacement tubes will be readily available throughout the life of that equipment!

Thus while Heintz and Kaufman will continue to develop new and improved Gammatrons, these advancements will never embarrass the equipment manufacturer since they will not result in the discontinuance of any Gammatron type.

We are starting this program off by standardizing the specifications for 22 Gammatron types, the outstanding products of our 17 years of tube research and development.

The electrical and physical uniformity and quality of these 22 types will be maintained at the level of Joint Army and Navy specifications. We feel that these specifications are sufficiently high to serve as a sound basis for our standardization policy.

With the establishment of this progressive policy, Heintz and Kaufman Ltd. is taking the

lead to end the problem you have always faced of redesigning equipment in production because of variations in type characteristics, and to prevent the premature obsolescence of equipment from the same cause.

Here are the 22 types of Gammatrons which we pledge will be available during the years ahead, always conforming to the same high specifications:

14 TRIODES: HK-24, 24G, 54, 254, 354C and E, 454L and H, 654, 854L and H, 1054L, 1554, 3054.

1 PENTODE: HK-257B.

4 HIGH VACUUM RECTIFIERS: HK-253, 953B, D, and E.

3 IONIZATION GAUGES: VG-2, VG-24G, VG-54.

Our advertisement next month will contain additional data on the above types, and will also include a list of Gammatrons available primarily for replacement use.

Have you written for  
the specification sheet on the  
HK-1054 Gammatron?

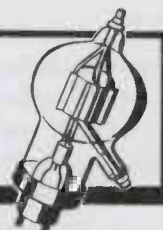

**HEINTZ AND KAUFMAN LTD.**  
SOUTH SAN FRANCISCO • CALIFORNIA

*Gammatron Tubes*

Export Agents: M. Simons & Son Co., Inc. 25 Warren Street, New York City, N. Y., U. S. A.



BUY WAR  
BONDS

# MEC-RAD

## ELECTRONIC COMPONENTS



*Navy plane patrolling the water off Saipan on "D-Day" for that Marianas base. Official U. S. Navy Photography.*

### ★ add a margin of safety for navy pilots

Vital to the success of our air attack are ingenious electronic devices. Mec-Rad is now devoted 100% to the manufacture of vital mechanical and electro-mechanical assemblies for these important electronic units.

Our work includes "fancy brass plumbing" of all types involving soft and hard soldering, close tolerances, precision machining, careful assembly and finishes ranging from lacquered to silver and rhodium plating.

We will continue this program as long as our services are needed—but after the war our specialized facilities will be available to the electronic industry. Our engineering "know-how" based on years of experience designing and manufacturing precision mechanical-electrical components is at your service now to help you with your post-war planning.



# MEC-RAD

## DIVISION-BLACK INDUSTRIES

1400 EAST 222ND STREET ☆ CLEVELAND 17, OHIO

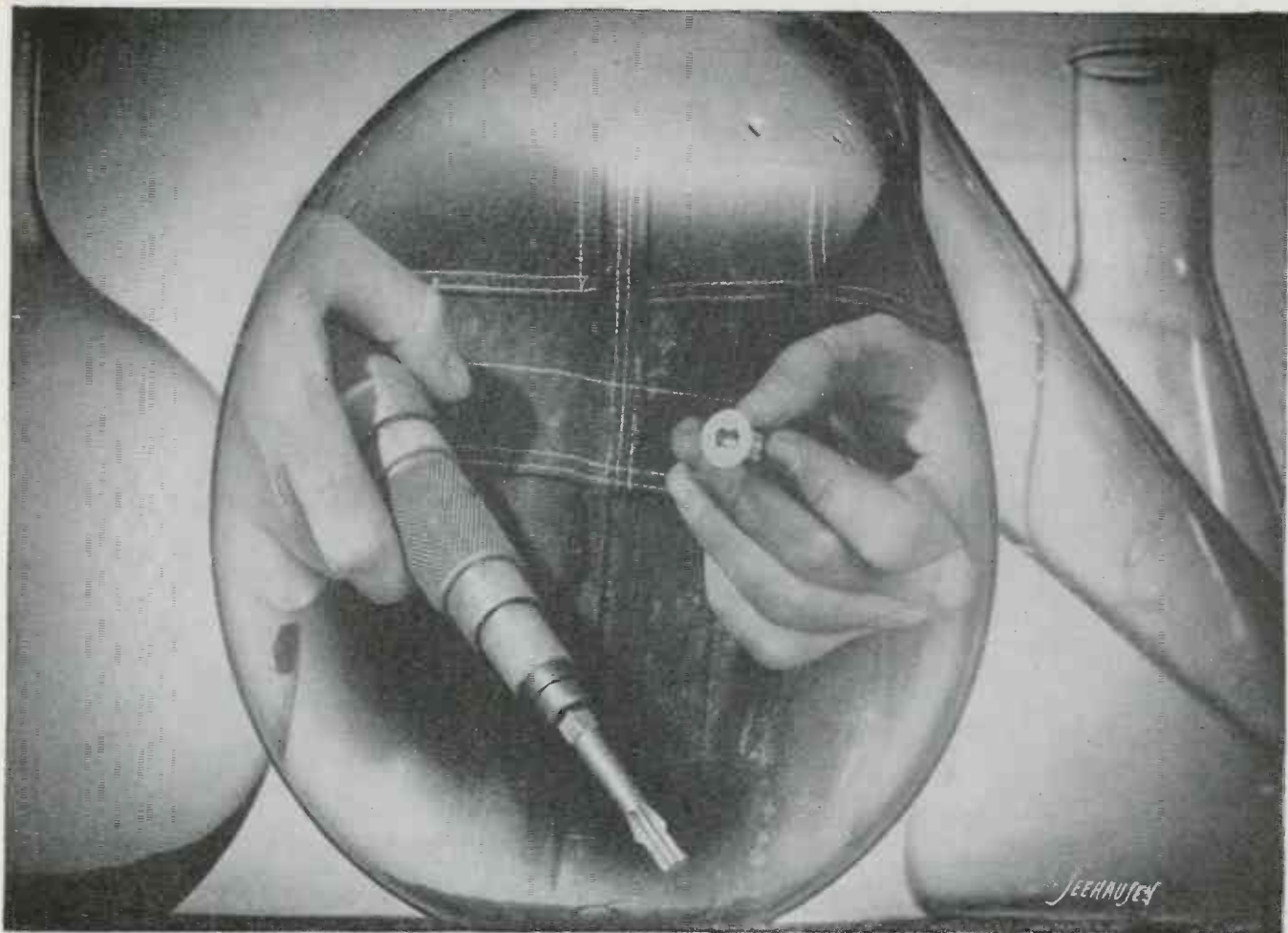

*Your Own Assembly Line* is the only "test tube" that can correctly measure the outstanding performance of CLUTCH HEAD Screws . . . for the lower cost that comes from smoother, faster and safer driving. Compare these CLUTCH HEAD advantages, of both screw and driver, with any other screw on the market:

- ★ Center Pivot insures dead-center entry to prevent canting; makes straight driving automatic.
- ★ Deep positive engagement for definite torque drive, elimination of chewed-up heads, and protection against slippage to damage manpower and materials.
- ★ Square instead of "tapered" engagement disposes of "ride-out" tendency and reduces end pressure fatigue to a minimum.
- ★ The exclusive CLUTCH HEAD Lock-On which unites screw and bit as a unit for easy one-handed reaching and driving.
- ★ The unmatched tool economy of the Type "A" Bit which drives home extra thousands of screws, *uninterruptedly* . . . and which may be repeatedly reconditioned to original efficiency by a 60-second application of the end surface to a grinding wheel.
- ★ CLUTCH HEAD's simplification of field service . . . because it is the *only* modern screw operative with an ordinary type screwdriver.

So that you may get a first-hand understanding of these many advantages, you are invited to send for a package assortment of

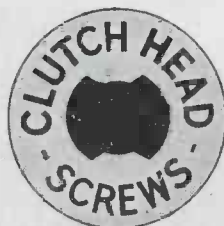

CLUTCH HEAD Screws, sample of the Type "A" Bit, and illustrated Brochure. These will be sent you by mail and without obligation.

**UNITED SCREW AND BOLT CORPORATION**

**CHICAGO 8**

**CLEVELAND 2**

**NEW YORK 7**

# Dependable

## VARIABLE RESISTORS

### SPACE REQUIREMENTS FOR 35 SERIES AND AC-35 SERIES

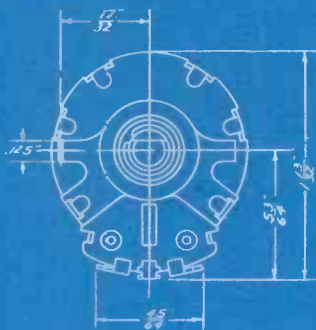
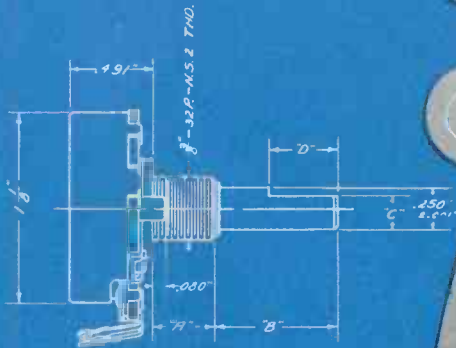

35 SERIES (above)

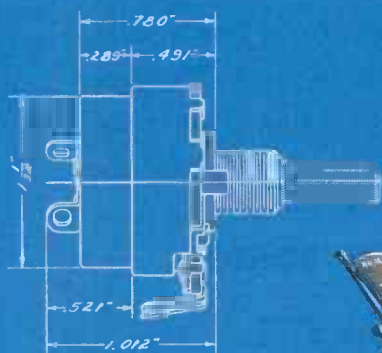

AC-35 SERIES



1 1/2 times actual size

Dependability in CTS variable resistors is considerably more than just meeting a customer's specifications. Years of research and experience in this one highly specialized field have taught CTS engineers to fit their products to each customer's needs.

It sometimes happens, in the hectic process of drawing up specifications for a new product, that some slight error creeps in. This must be corrected later at the manufacturer's expense. CTS avoids this costly procedure by submitting samples on each variable resistor order for new applications. Thus oversights are corrected *before* production begins.

Such complete dependability in every phase of operation has made CTS variable resistors the leaders throughout the world.

CTS delivery promises are as dependable as CTS products. For your variable resistor needs, call on Chicago Telephone Supply Company.

*Manufacturers of Quality Electro-Mechanical Components Since 1846*

VARIABLE RESISTORS  
PLUGS AND JACKS  
SWITCHES, RINGERS  
TELEPHONE GENERATORS

#### REPRESENTATIVES

R. W. Farris Co.  
406 West Thirty-fourth Street  
Kansas City 2, Missouri  
Phone: Logan 7495

Frank A. Emmet Co.  
2837 West Pico Boulevard  
Los Angeles 6, California  
Phone: Rochester 9111

BRANCH OFFICES  
S. J. Hutchinson, Jr.  
401 North Broad Street  
Philadelphia 8, Pennsylvania  
Phone: Walnut 5369

IN SOUTH AMERICA  
Jose Luis Pantet

Cordoba 1472  
Buenos Aires, Argentina  
South America

IN CANADA  
C. C. Meredith & Co.  
Streetsville, Ontario

Masculino 2624  
Montevideo, Uruguay  
South America

IN ENGLAND  
Chicago Telephone Supply Co.  
St. John's Woods  
103 Grove End Gardens  
London, N. W. 8, England

Av. Cons. Rodrigues  
Alves 1057  
Sao Paulo, Brazil  
South America



**CHICAGO TELEPHONE SUPPLY**  
*Company*

ELKHART INDIANA

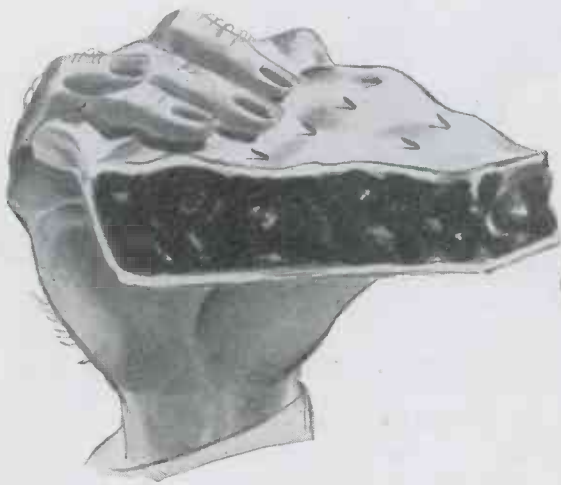

## *We bit off what we could chew*

With the advent of war, we shifted a portion of our facilities from the manufacture of steel office furniture to the production of electronic equipment. It was a new field to us and we bit off only what we could chew. As soon as that was digested, we went back for more. Today, with our accumulated experience, we feel right at home in the electronic equipment field—definitely plan to stay in it after the war in addition to our office furniture work.

The foundation of our success? Well, it's been a combination of accurately meeting customer specifications and doing it for a fair return. Sound interesting to you? We hope it does because we'd like to add your name to the many leaders in the industry whom we are serving now.

**BUY WAR BONDS**



**LET WHITAKER  
produce your wiring assemblies!**



## **A LOWER COST of MANUFACTURING is one of many advantages Whitaker offers you on Cables, Wiring Harnesses and Assemblies**

You can save time, grief and money by utilizing our specialized facilities for producing wiring assemblies, flexible leads, and other cable products . . . Furthermore, the economies gained will be big factors in enabling you to lower your cost of manufacturing . . . No job is too complicated for us. Our experience is broad, and our production facilities are adequate . . . During the past 25 years we have supplied cables to manufacturers of

*Whitaker  
Can  
Wire It*

a widely diversified list of products, and our present-day facilities should be of great value to makers of trucks, tractors, trailers, tanks, radios, electric ranges, hot water heaters, airplanes, ships, electric appliances, battery chargers, scientific equipment, and many other items . . . In addition to an engineered wiring service, Whitaker also offers a quality line of standard cable products . . . We cordially invite you to write to us.

### **WHITAKER CABLE CORPORATION**

General Offices: 1311 Burlington Avenue, Kansas City 16, Missouri  
Factories: Kansas City, Mo. • St. Joseph, Mo. • Philadelphia • Oakland

# PRECISION-BUILT RELAYS



ONE OF THE "400" SERIES

by **COOK**

## "Extra-Ordinary" ENGINEERING

Cook relays are designed and engineered in modern laboratories by engineers who have the finest production and testing equipment at their disposal. Fine equipment in itself, however, is not always the basis of good engineering. The men in Cook laboratories must also qualify by possessing sound, practical and theoretical engineering principles. These principles are not only prevalent in the men in our laboratories, but are also characteristics of our entire staff of field engineers. These are the men located throughout the principal cities in the United States and Canada, who are at your disposal when any relay problems present themselves.

2700 SOUTHPORT  
AVENUE

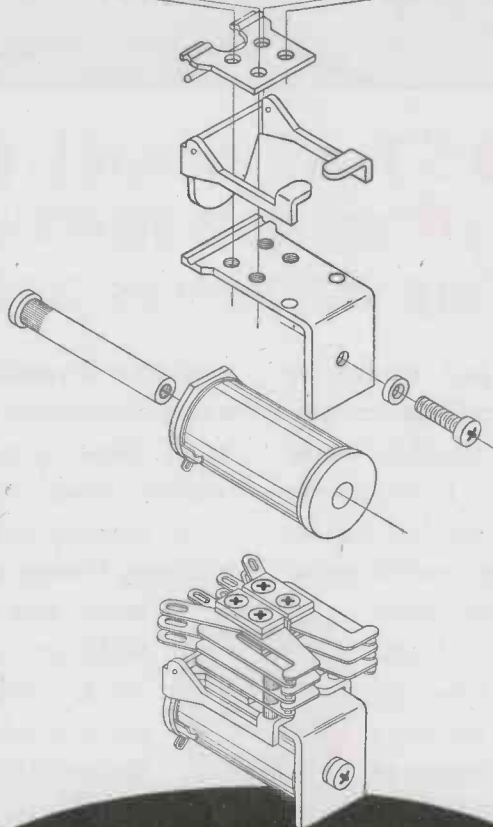

## "Extra-Ordinary" CRAFTSMANSHIP

The stamp of craftsmanship in the manufacture of Cook relays starts in the drafting room. It is there that careful drawings, such as the accompanying illustration, are prepared. From this drawing through the specification of the best and highest grades of materials, precision manufacture of all parts, the careful assembly, and the rigid testing of the completed relay, every step along the way is an operation in which Cook craftsmen take pride.

The relay illustrated is one of the new "400" series of small Cook relays. It is 1-7/16" L. by 1-5/16" W. by 1-7/16" H., operates normal coil voltage of 28 volts. Will operate at 14 volts and maintain proper contact pressure over 30 grams. Operating time less than 10 milliseconds.

**COOK ELECTRIC**  
Company

CHICAGO 14,  
ILLINOIS



# These U. S. Navy Planes Carry Collins Autotune Transmitters

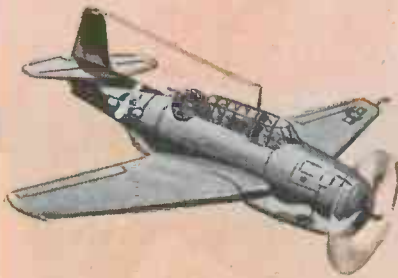

GRUMMAN TBF AVENGER



PB2Y-3 CORONADO



MARINE CORPS PBJ MITCHELL

## The voice of thousands of Navy fliers



THE COLLINS ATC Autotune transmitter is regulation equipment for most two-place-and-larger types of Navy aircraft. It is the military successor of Collins airborne Autotune transmitters which were adopted by several of the great commercial airlines years before the war. Since Japan struck, the Navy has ordered many thousands. In advanced design and rugged construction, today's ATC reflects the lessons of war learned in every quarter of the world. It is a foretaste of the reliability and efficiency to be expected of Collins by commercial and private users after victory. Collins Radio Company, Cedar Rapids, Iowa; 11 West 42nd Street, New York 18, N. Y.



CURTISS SB2C-1 HELLDIVER



PB4Y-2 PRIVATEER



MARTIN PBM-3D MARINER



IN RADIO COMMUNICATIONS, IT'S . . .



# How many spots in communications equipment can you find for this newest MICARTA product?



Here's a new boost, and a challenge, to communications and electronic designers . . . coil forms from Micarta "444", the latest Westinghouse development in industrial plastics.

These strong, lightweight forms provide greater freedom in production due to the insulating characteristics and resistance to heat, cold, humidity and chemicals—characteristics found in *all* Micarta plastics. Both small and medium size forms can be economically made from Micarta "444" for small-run production jobs.

Micarta "444"—a phenolic resin with a fabric base—is easily formed on inexpensive and quickly-constructed plastic or wooden dies. A simple arbor press with only 100 pounds per square inch pressure can do the job handily. Micarta "444" can be formed or bent into a variety of shapes from flat, cured sheets with perfect uniformity (see examples above).

Micarta "444" has already found many uses in radio and communications equipment. How many can you find in your own product designs? Your nearest Westinghouse office will be glad to explore its possibilities with you. Or write Westinghouse Electric & Mfg. Co., P. O. Box 868, Pittsburgh 30, Pa. J-94667



**JUST HEAT** . . . premolded and cured sheets are heated uniformly on both sides by infrared lamps for specified time.

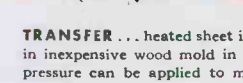

**TRANSFER** . . . heated sheet is then quickly placed in inexpensive wood mold in arbor press or where pressure can be applied to mold.

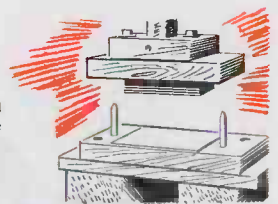

**AND FORM** . . . pressure of about 100 psi is applied and shape cooled briefly in mold.

## Westinghouse

PLANTS IN 25 CITIES . . . OFFICES EVERYWHERE



...one of many Westinghouse contributions to progress in electronic and communications equipment design

Micarta "444" is one of many Westinghouse products developed especially to meet engineers' demands for their new designs.

Here is a quick check list of some important Westinghouse developments . . . what they are, where to use them, what they will do. Like Micarta, each possesses characteristics giving designers greater freedom and flexibility.

Your nearest Westinghouse office can give you complete data on any of these exceptional communications products. Ask for the book number shown in parentheses on each item.

## A QUICK CHECK LIST OF SOME WESTINGHOUSE COMMUNICATIONS PRODUCTS

### MATERIALS

#### Hipersil Cores . . .



Ready - to - assemble **Hipersil** cores have  $\frac{1}{3}$  greater flux-carrying capacity and eliminate time-wasting stacking of tissue-thin laminations by hand. (B-3223-A)

#### Tuffernell Insulating Materials . . .



Developed during 50 years of field experience, Westinghouse "Tuffernell" insulating materials supply the *right* grade needed for numberless communications jobs. (B-3322-A)

#### Solder-Seal Prestite . . .



New high-strength Zircon Prestite offers remarkable versatility for communications products . . . it has low loss, high resistance to thermal and mechanical shock and can be supplied with standard Solder-Seal for true hermetic joining to metals. (B-3244)

### PARTS AND ASSEMBLIES

#### Inerteen Capacitors . . .



Light weight, small volume and high reliability are features of Inerteen Capacitors for d-c service at 400 to 250,000 volts. Inerteen—the liquid dielectric is nonflammable . . . non-explosive. (B-3300)

#### Electronic Tubes . . .



Uniform, trouble-free, long-life service is built into every electronic tube in the Westinghouse line . . . **Pilotrons**, **Kenotrons**, **Phototubes**, **Thyratrons** and **Ignitrons**. (SP-204)

#### Instruments . . .



Westinghouse instruments range from miniature panel size to 4-foot boiler room indicators for all types of mountings. (B-3283)

#### Thermostats . . . Heaters . . .



If it takes electric heat, Westinghouse can help solve the control problem with a well-stocked line of thermostats that will handle any job up to 650° F. The tiny thermostat illustrated is for final temperature control in a crystal oven. (B-3344)

#### Dynamotors, Motors and Blowers . . .



Smooth, functional design gives these rotating components high flexibility for radio equipment. Light weight and compactness are the keynotes in the design of these long-lived devices. Available for a wide range of frequencies and voltages. (B-3242)

EQUIPMENT FOR THE  
COMMUNICATIONS INDUSTRY

# INDOOR . . . . OUTDOOR

## IN ALL KINDS OF WEATHER

### HIGHER ARTICULATION WITH LESS FATIGUE



## *Electro-Voice* MODEL 600-D



A moving coil, hand-held dynamic microphone for such applications as . . .

- MOBILE PUBLIC ADDRESS • SPORTS PICK-UPS
- POLICE SERVICES • DICTATING EQUIPMENT
- MARINE SERVICES • SPEECH RECORDING

Exhaustive tests have proved that a uniform response to all frequencies between 200-4000 c.p.s. will give higher articulation, provide more usable power level, and be less fatiguing to the listener than one which is peaked. These advantages are assured in the Electro-Voice Model 600-D because the frequency response is unweighted and substantially flat. Where ambient noise does not interfere or distract, high fidelity speech transmission is provided, indoors or outdoors . . . in any kind of weather.

**OUTPUT LEVEL RATING:** Power: 56 db below 6 milliwatts for 10 dynes/cm pressure. Voltage (high impedance): 5 db above .001 volt/dyne/cm<sup>2</sup>, open circuit. Voltage developed by normal speech (100 dynes/cm<sup>2</sup>): .177 volt.

**FREQUENCY RESPONSE:** 100-6000 c.p.s.

**WEIGHT:** 9 ounces.

**HARMONIC CONTENT:** Less than 2% at all frequencies.

**DIAPHRAGM:** Made of heat-treated duralumin, corrosion inhibited.

**VOICE COIL:** Made of pure aluminum, high-Q design.

**CASE:** Constructed of finest quality, high impact phenolic.

**PRESS-TO-TALK SWITCH:** Sliding contact, self cleaning type; standard circuit opens microphone and closes relay simultaneously. Other combinations optional.

**TRANSFORMER CORE:** Made of nickel alloy, hydrogen annealed metal; low capacity windings.

**MAGNETIC CIRCUIT:** Employs Alnico V and Armco magnetic iron.

**IMPEDANCES:** Hi-Z (Direct-to-Grid), 50, 200, 250, or 500 ohms.

Equipped with 6 feet of two conductor and shielded synthetic rubber jacketed cable.

Model 600-D, List Price \_\_\_\_\_ \$27.50

Model 600-DL, with switch lock, List Price \_\_\_\_\_ \$29.00

See your nearest radio parts distributor today. His knowledge of Electro-Voice microphones may aid you in selecting the appropriate type for your specific needs. He may also be an important factor in speeding your order.

SUPPORT  
THE SEVENTH  
WAR LOAN  
DRIVE

## *Electro-Voice* MICROPHONES

ELECTRO-VOICE CORPORATION • 1239 SOUTH BEND AVENUE • SOUTH BEND 24, INDIANA  
Export Division: 13 East 40th Street, New York 16, N. Y., U. S. A. Cables: Arlab



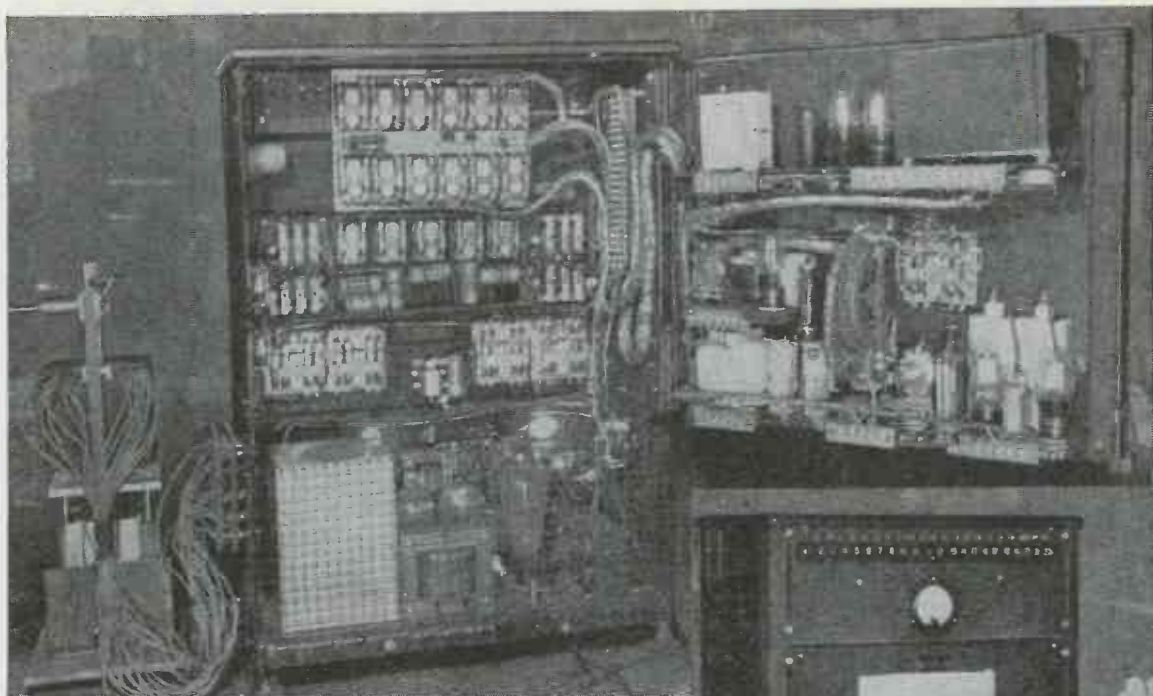

Rear view of new **FOSTER "ROBOT"** TESTING APPARATUS. Open panel reveals complex electrical units.

Front view of "ROBOT." Controls are few and easy to operate. High-precision readings visible at a glance.

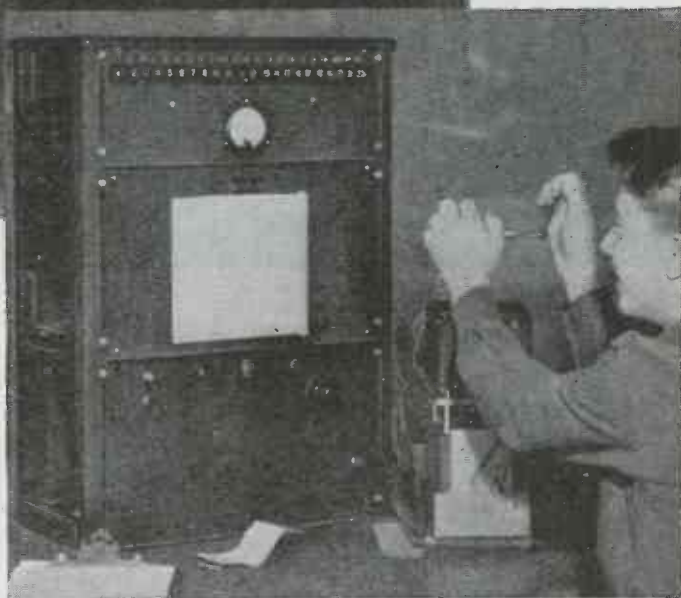

## FOSTER AUTOMATIC "ROBOT" ELIMINATES HUMAN ELEMENT IN TRANSFORMER INSPECTION

This is the new Foster "Robot"—an ingenious Foster development designed to eliminate fallible human judgment in the final test and inspection of Foster transformers.

The "Robot" is never tired. Its judgment never fails. It has no memory, and no conscience—it accepts or rejects automatically. All in one operation this stern mechanism tests core loss, turns ratio, leakage resistance and winding resistance. All Foster transformers must meet the "Robot's" requirements, both for usual running conditions as well as a high specified safety margin. And the "Robot" does this vital work faster,

more accurately and more uniformly than was ever possible before.

Designed to meet the heavy demands of Foster's war-time commitments, the new Foster "Robot" will continue as an integral part of Foster testing equipment after the war. It is one more assurance that your peacetime Foster transformers will maintain the highest possible standard of performance. And, because it is a time-saver, the "Robot", together with Foster's other streamlined techniques, will actually save you money.

**BOB REID**  
810 West 57th Street  
Indianapolis 5, Ind.  
Telephone Broadway 2725

**BAUMAN AND BLUZAT**  
2753 West North Avenue  
Chicago 47, Ill.  
Telephone Humbolt 6809-10-11-12

**THE A. P. FOSTER COMPANY**  
**BARRETT BORDER**  
11 W. 42nd St., New York 18, N. Y.  
Telephone Pennsylvania 6-9133

SPECIALISTS IN BUILDING TRANSFORMERS SINCE 1938

# A. P. FOSTER COMPANY

TRANSFORMER ENGINEERS & MANUFACTURERS  
719 WYOMING AVENUE, LOCKLAND 15, OHIO

# "Take a Number from 1 to 9999"

## MICRO SWITCH

### SNAP-ACTION

Will "Remember" It even at 2500 r.p.m.

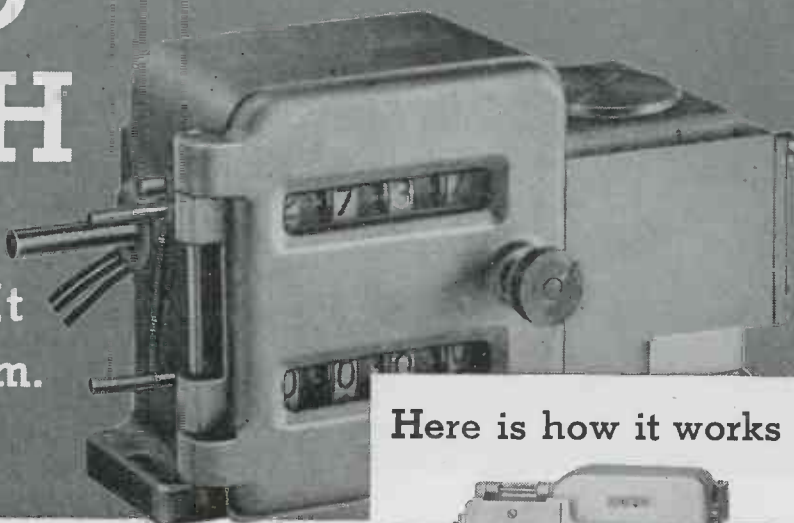

### Here is how it works

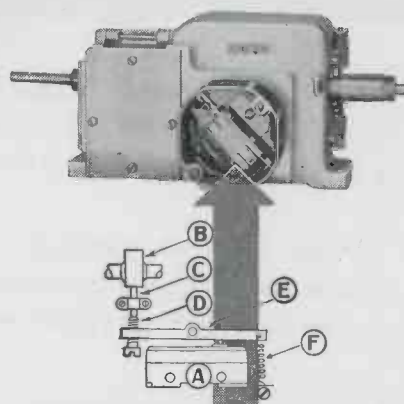

This Cycle Repeater of the Counter and Control Corporation of Milwaukee, Wisconsin, employs a Micro Switch snap-action switch to make or break the circuit at any predetermined number from 1 to 9999.

The Counter and Control Corporation chose a Micro Switch product for the operating heart of this Cycle Repeater because of its proven accuracy of response through millions of repeat operations. Too, its tiny, compact size combines with its rugged construction to meet the needs of their application.

This device is an automatic, predetermined counter, self-resetting and self-repeating . . . something new in controlled production. It is used as an integral part of production machinery to control cycles, operate signals, lights, bells, relays, motors, conveyors and elevators.

Once the predetermined number is set, the Cycle Repeater can be run at as high a speed as 2500 r. p. m., and the snap-action switch will make or break the contact at the point required. This is accomplished by a cam which actuates the switch after the proper sequence of gear revolutions in the counter mechanism.

Hundreds of designers, in every branch of industry, are finding the ability of Micro Switch products to switch substantial loads at line voltage . . . without the use of relays . . . makes them ideally suited for a wide variety of electrical controls in both war and peace production. Design engineers should know all about these Micro Switch controls. We'll be glad to send you as many copies of our Handbook-Catalog as they may require.

The plastic enclosed switch "A" is bolted to a bracket which is attached to the counter housing.

After the proper sequence of gear revolutions in the counter mechanism, a cam "B" on the gear arrangement presses the plunger "C" against the adjusting screw "D".

The lever pivoted at "E" then causes the bar to release its pressure on the switch plunger which either opens or closes the electrical circuit as desired. Spring "F" acts as a counterbalance to restore immediately the pressure on switch plunger for another cycle of operations.

LET'S ALL BACK THE ATTACK BUY EXTRA WAR BONDS



© First Industrial Corporation

# MICRO SWITCH

TRADE MARK

A DIVISION OF FIRST INDUSTRIAL CORPORATION

Freeport, Illinois, U. S. A., Sales Offices in Principal Cities



This is the basic switch—a thumb-size, feather-light, plastic enclosed, precision, snap-action switch. Underwriters' listed and rated at 1200 V. A., at 125 to 460 volts a-c. Capacity on d-c depends on load characteristics. Accurate reproducibility of

performance is maintained over millions of operations. Basic switches of different characteristics are combined with various actuators and metal housings to meet a wide range of requirements.

ELECTRONIC INDUSTRIES • May, 1945

# Inductor Designs

for RADIO TRANSMITTERS and INDUSTRIAL USES

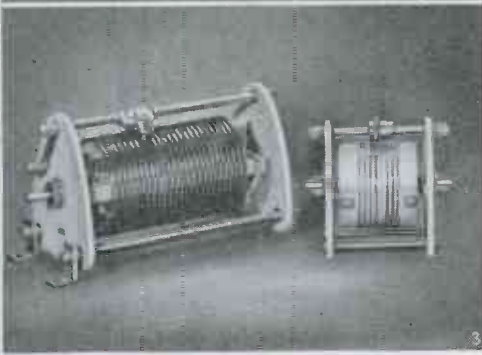
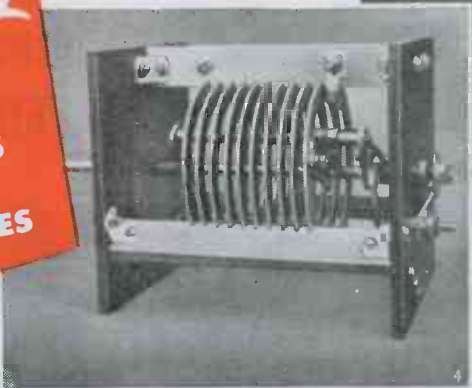
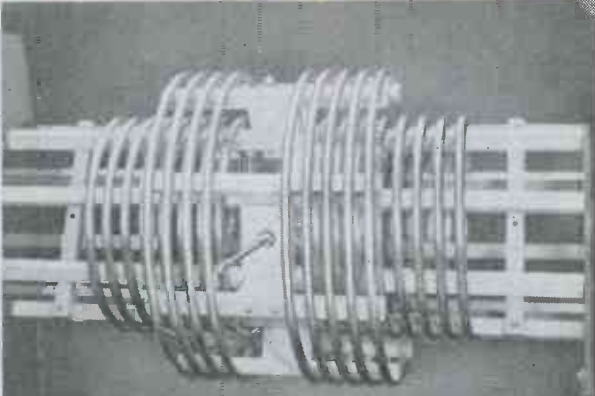

When you need an inductor for any purpose consult Johnson Engineers. Their files will probably contain a design for your required inductor, but if not, they can design one and make it to do your particular job.

Inductor design is quite a special study and no one conductor, no one insulator, no one type of construction is suitable for every requirement. Johnson may select a copper tubing conductor to handle high currents in one design, while edgewise strip is selected in another because of its narrow width and the ability to get a greater inductance in the same length. Other conductors are available too, such as solid wire, litz wire, flat strip, square Bars and special shapes, some plated, some polished and lacquered according to their use. In order to make contact to the conductor and bring off taps Johnson has produced a complete line of clips and connectors for use on fixed taps as well as sliders and rollers for continuously variable taps.

Insulation requirements vary. While steatite or mycalex may be used for low losses in a certain high frequency coil, plastics may be better for another because they stand more mechanical shock. Production facilities at Johnson provide for working any insulating material so the best one or the best combination, can always be selected to fit the special job.

Johnson inductors are designed and built for efficient operation and they have high Q. Some are fixed and some are variable. Some designs require special features such as rounded parts to minimize corona discharges at high voltages, water cooling, variation of inductance or variation of coupling.

What is your inductor requirement?

## OTHER JOHNSON COMPONENTS

- SOCKETS
- CONDENSERS
- INSULATORS
- PLUGS and JACKS
- COUPLINGS

Ask for

Catalog 968-O



# JOHNSON

*a famous name in Radio*

E. F. JOHNSON COMPANY • WASECA • MINNESOTA

ELECTRONIC INDUSTRIES • May, 1945

It was a world's record  
when Nickel tubing was  
drawn finer than a  
**MOSQUITO'S STINGER . . .**



The former record holder compared with a mosquito's stinger. 0.0019" O.D. 0.0004" I.D.

**. . . but now . . .**  
Nickel tubing has been  
drawn as fine as the  
**VEINS in a FLY'S WING**

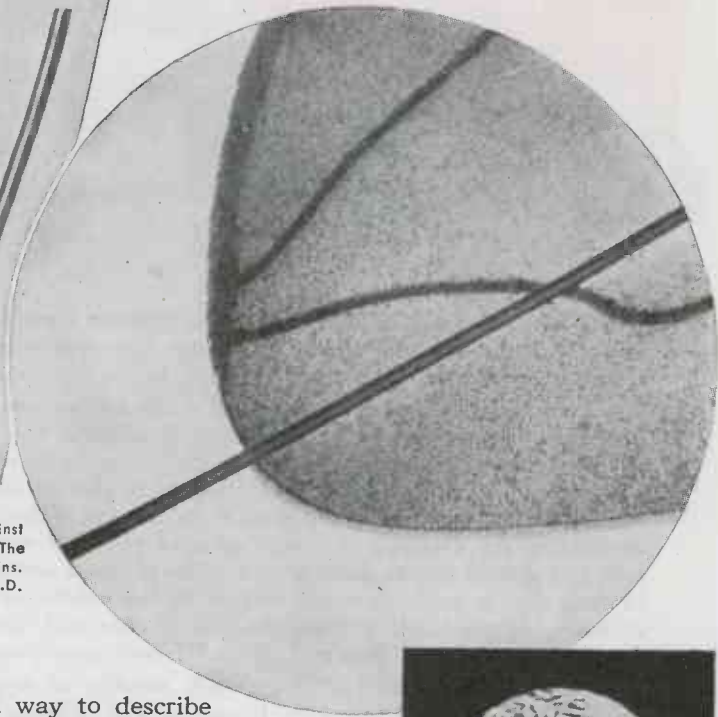

World's smallest tube against the tip of a fly's wing. The gray lines are two fine veins. 0.0014" O.D. 0.0004" I.D.

**"Extremely workable!"**

That's a good way to describe the INCO Nickel Alloys. For they can be produced in sizes ranging from the giant forged gate stems used at Boulder Dam down to wire smaller than human hair . . . strip one-third the thickness of this page . . . tubing as fine as the veins in a fly's wing.

The accompanying pictures amply prove this workability. Both tubes are made of pure Nickel—the metal found best for such fine drawing by the Superior Tube Company, Norristown, Pa.

The new world's smallest metal tube is so small that 37 piled one atop the other would only equal the thickness of a dime—and one pound would stretch more than 33 miles.

Another good way to describe the INCO family of Nickel Alloys is to call them, "**strong, tough metals that resist heat, rust, corrosion, fatigue and wear.**"

In addition to these group characteristics, the INCO Nickel Alloys also offer individual electrical properties uniquely suiting them to specific jobs in the electronic field.

You'll find properties and typical applications of these problem-solving metals interestingly described in "*Tremendous Trifles.*" Your copy will be mailed on request. The International Nickel Company, Inc., 67 Wall Street, New York 5, N. Y.

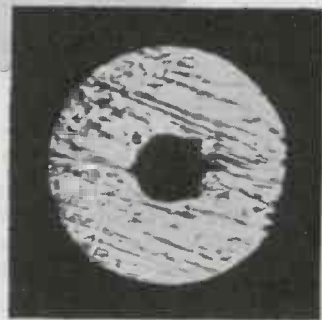

Cross-section of world's smallest metal tube. The bore is only 4 ten-thousandths of an inch. (Magnified 900X.)

NOTE: INCO Nickel Alloy tubing is drawn commercially to sizes down to 0.010" O.D. The world's smallest sizes are not yet produced commercially.

**NICKEL  ALLOYS**

MONEL • "K" MONEL • 45" MONEL • "R" MONEL  
"KR" MONEL • INCONEL • "Z" NICKEL • NICKEL  
Sheet . . . Strip . . . Rod . . . Tubing . . . Wire . . . Castings . . . Welding Rods (Gas & Electric)



**New...**

**High melting point  
synthetic wax**

# ACRAWAX C

(Melting point ... 280° F.)

**10**  
Important  
Uses For  
ACRAWAX C

- Insulating Compounds
- Impregnants
- Cable Saturants
- Lacquers
- Synthetic Elastomers
- Sealants
- Potting Compounds
- Asphaltic Compounds
- Varnishes
- Synthetic Resins

## PARTIAL LIST OF PROPERTIES OF ACRAWAX C

- 1** ACRAWAX C has an extremely high melting point (280°F.), and is also used to raise the melting point of other materials. It has a tendency to produce amorphous characteristics in its blends. Added resistance to cold flow is also imparted.
- 2** ACRAWAX C has excellent dielectric properties, and good power factor.
- 3** ACRAWAX C is insoluble in water, imparts marked water resistance and salt spray resistance to its blends. It is insoluble in practically all solvents in the cold.
- 4** ACRAWAX C melts to a liquid of low viscosity, thus facilitating penetration and impregnation.
- 5** ACRAWAX C contains no chlorine.
- 6** ACRAWAX C is compatible through hot melt procedure with a wide range of materials, many of which serve to modify it to give additional valuable characteristics such as greater adhesion, more flexible film, etc., as desired.
- 7** ACRAWAX C imparts anti-tack and anti-blocking characteristics to its compounds.



**Request  
Free  
Bulletin on  
ACRAWAX C**

from Glyco Products Co., Inc.  
26 Court St., Brooklyn 2, N. Y., Dept. G

Firm \_\_\_\_\_

Name \_\_\_\_\_

Address \_\_\_\_\_

**GLYCO PRODUCTS  
CO., INC.**

26 COURT STREET, BROOKLYN 2, N. Y.

**ONLY I C E VACUUM CAPACITORS**  
 give you the precise  
 capacitance value  
 you want

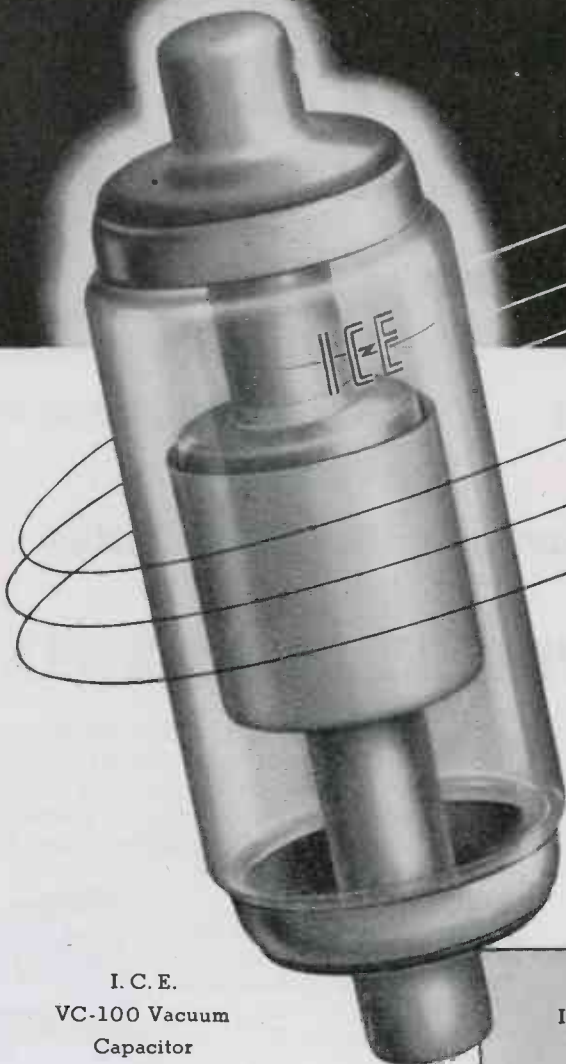

I. C. E.  
 VC-100 Vacuum  
 Capacitor

Now I. C. E. makes it possible for you to order vacuum capacitors with the correct capacitance value to meet requirements of your equipment. I. C. E. Vacuum Capacitors are now available in any value range from 6 to 110 mmfd. in steps of 1 mmfd.

**I. C. E. Vacuum Capacitors Give You Close Tolerances**

Beside offering you a wide range of capacitance values, I. C. E. Vacuum Capacitors are built to give you previously unobtainable tolerances.

**I. C. E. PRECISION GRADE VACUUM CAPACITORS**

<i>Value Range</i>	<i>Accurate to</i>
6 mmfd. to 25 mmfd.	$\pm 0.5$ mmfd.
26 mmfd. to 60 mmfd.	$\pm 1.0$ mmfd.
61 mmfd. to 110 mmfd.	$\pm 1.5$ mmfd.

**I. C. E. XX GRADE VACUUM CAPACITORS**

<i>Value Range</i>	<i>Accurate to</i>
6 mmfd. to 25 mmfd.	$\pm 0.2$ mmfd.
26 mmfd. to 60 mmfd.	$\pm 0.3$ mmfd.
61 mmfd. to 110 mmfd.	$\pm 0.5$ mmfd.



ELECTRONIC TUBES  
 RESEARCH • DESIGN • PRODUCTION

**Full Details in the New I. C. E. Catalog**

For full information on these outstanding I. C. E. Vacuum Capacitors, as well as other precision I. C. E. products, write today for the new I. C. E. Catalog.

**INDUSTRIAL & COMMERCIAL ELECTRONICS**

BELMONT, CALIFORNIA • NEW YORK CITY, N. Y.



# MECK

★ ★ **MEANS PERFECTION** ★ ★

John Meck crystals are now—and always will be—characterized by high quality and rigid precision. In an industry as exacting in mechanical design and as intricate in conception and execution as the field of sound electrically controlled and amplified, the engineering staff must work to standards of “absolute” precision. This devotion to accuracy is reflected in the attitude and work of every individual contributing to the completion of John Meck products. The low percentage of final test rejections at John Meck Industries is a tribute to the splendid, conscientious personnel and their ability.



**JOHN MECK INDUSTRIES, INC.**  
PLYMOUTH, INDIANA, U. S. A.

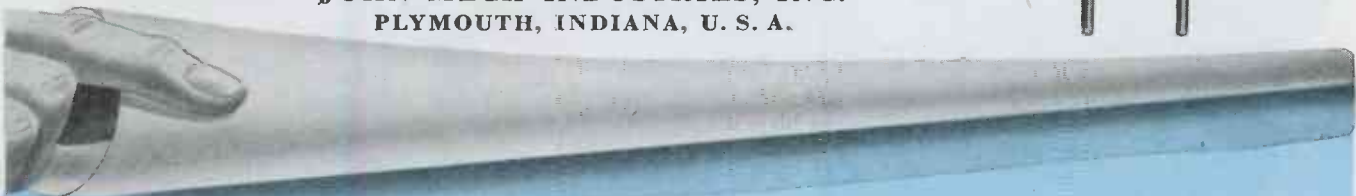

John Meck Industries, Inc., will produce radio receivers and phonographs on the resumption of civilian production. Your salesmen will find that our purchasing department is interested in

establishing dependable sources for parts and supplies. Our requirements will represent a growing volume of business through the years.

*John Meck*

Camp Coles Signal Laboratories  
Red Bank, N. J.



**SCGSA**  
(SIGNAL CORPS GROUND SIGNAL AGENCY)

# ... BIRTHPLACE OF

The Laboratory . . . here are born electronic weapons that are making history. Our American systems of army communications have proved mighty factors in our fighting successes, due primarily to the remarkable achievements of the Signal Corps Laboratories, known as SCGSA, comprising a chain of research units under one centralized supervision. At one of these Laboratory Units, Camp Coles (pictured above), was conceived the SCR-694, a compact, lightweight, highly versatile and efficient two-way radio telephone and telegraph outfit, for use in vehicles, as a portable ground station or front line command post.

It is a pleasure to give full recognition to the creative genius and organization of SCGSA and the really vital work it accomplishes, necessarily without public attention.

*Ell Rauland*

President, The Rauland Corporation

PORTABLE



FIELD OPERATION



VEHICLE OPERATION



Photos courtesy U. S. Army Signal Corps

**RADIO • • RADAR • • COMMUNICATIONS •**

*Rauland esteems it a high honor to have been*

# THE SCR-694

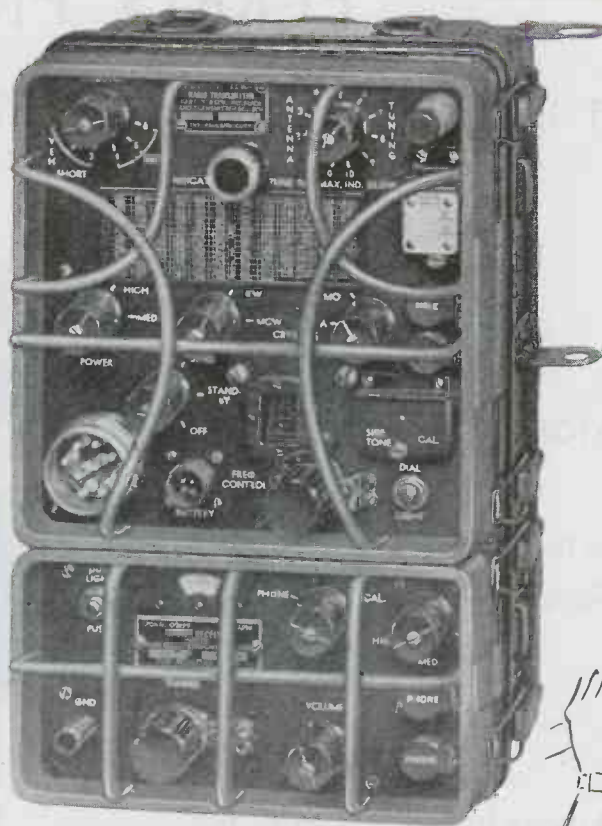

Quotes from field reports  
—from the Pacific:

"During a rainstorm the 694's were the only sets in one section that remained operative."

"The weight of the set, its construction, its features such as crystal control, etc., make it ideal for use in amphibious operations."

—From airborne source:

"One set (SCR-694) landed in a stream of water and although completely submerged (time undetermined) worked normally."

Whether in a foxhole or jeep, in jungle or on the beach, in a tropical downpour, blizzard or surf, the SCR-694 can "take it." When its switch is pressed, this radio is ON THE AIR.



## SCR-694 TRANSMITTER-RECEIVER

Weight 22 lbs. ★ range sufficient for vehicle use ★ waterproof and fungus proof ★ ideally adapted to jungle or sub-zero operation ★ powered by hand generator, gasoline engine or vehicular vibrator power supply ★ converted from vehicle to field use immediately.

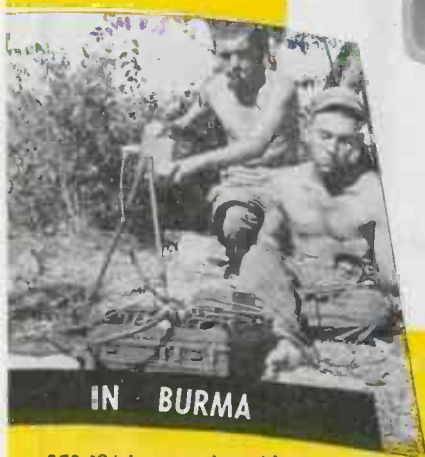

IN BURMA

SCR-694 in operation with America's newest fighting unit in Central Burma.

*Electroneering is our business*

# Rauland

SOUND

TELEVISION

THE RAULAND CORPORATION • CHICAGO 41, ILLINOIS

Selected by SCGSA for the development of SCR-694

# FERRIS INSTRUMENTS

ANOTHER NEW

FERRIS PRODUCT

WAS NOT INCLUDED IN OUR 45 CATALOG

MODEL 22D  
SIGNAL  
GENERATOR

Has all of the features of the well-known Model 22A Signal Generator, PLUS.



1. Covers the range from 85 kcs. to 40 mcs.
2. All voltages at end of 30 ohm terminated line.
3. FERRIS High Frequency step attenuator.
4. Large Output Meter improves accuracy, simplifies operation.
5. Exceptionally well shielded with extra line filter.
6. Has 3 ohm output tap for special applications.

**FERRIS**

FERRIS INSTRUMENT  
COMPANY

110 CORNELIA STREET, BOONTON, N. J.

# CLARE "Custom-Built" RELAYS

Are Send-Receive Relays in the  
Signal Corps' Famous SCR-299 Mobile Transmitter

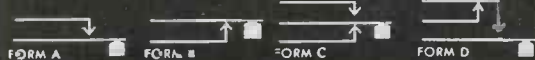
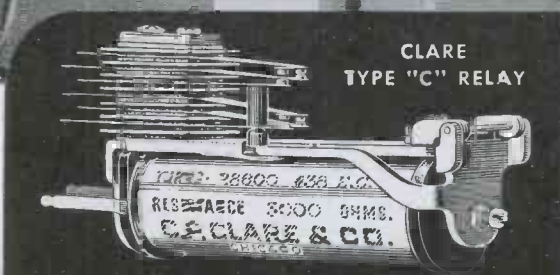

Contact springs employing any of these basic forms can be furnished.

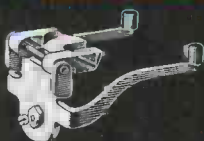

Double arm armature assembly of stainless steel shaft operating in a machine brass yoke. Heelpiece, spring armature assembly are of magnetic metal.



Spring bushing insulators are made of Bakelite rod under patented process. Resist vibration and withstand heavy duty service.



High voltage spring pin-up insulators of special heat-treated Bakelite. Has minimum eddy flow properties, low moisture absorption, extends and permits punching without cracks or checks.



Contacts are welded to nickel silver springs by special process. May be of precious metals or alloys in 12 different standard or special types and sizes.

● In the forefront of land operations in every war theatre has been the Signal Corps' famous SCR-299 mobile intercommunication unit, whose transmitter is built by The Hallicrafters Company of Chicago, Illinois.

Clare Type "C" d.c. Relay is used as a part of the speech amplifier of the SCR-299. Its function is that of the control relay for the circuit which changes over the equipment from "send" to "receive" or from "receive" to "send." Under certain conditions the relay is controlled by an impulse sent over as much as a mile of telephone wire from a remote observation or command post.

This Clare Relay has stood up remarkably well in the field and has contributed greatly to the outstanding performance of the SCR-299. In choosing a Clare "Custom-Built" Relay for this important function, The Hallicrafters Company left nothing to chance. Clare performance was well known. Clare's ability to "custom-build" just the relay to serve as these important nerve centers simplified design and assured the quick, positive action and rugged dependability, the resistance to vibration that a mobile radio transmitter must have.

Illustrated here are a few of the Clare "custom-building" features that have revolutionized designing and made it possible for Clare Relays to reduce overall relay cost, simplify installation and assure more dependable performance in hundreds of applications, such as sequence control of machine tools, radio, radar or other electronic controls, electric eye controls, counting equipment and alarm systems.

Clare engineers are ready at all times to "custom-build" a relay to your exact requirements. Send for the Clare catalog and data book. Address: C. P. Clare & Co., 4719 West Sunnyside Avenue, Chicago 30, Illinois. Sales engineers in all principal cities. Cable address: CLARELAY.



# CLARE RELAYS

"Custom-Built" Multiple Contact Relays for Electrical, Electronic and Industrial Use

For the widest range  
of transmitting and  
severe-service  
electronic  
assemblies

# AEROVOX RATING- PLUS CAPACITORS

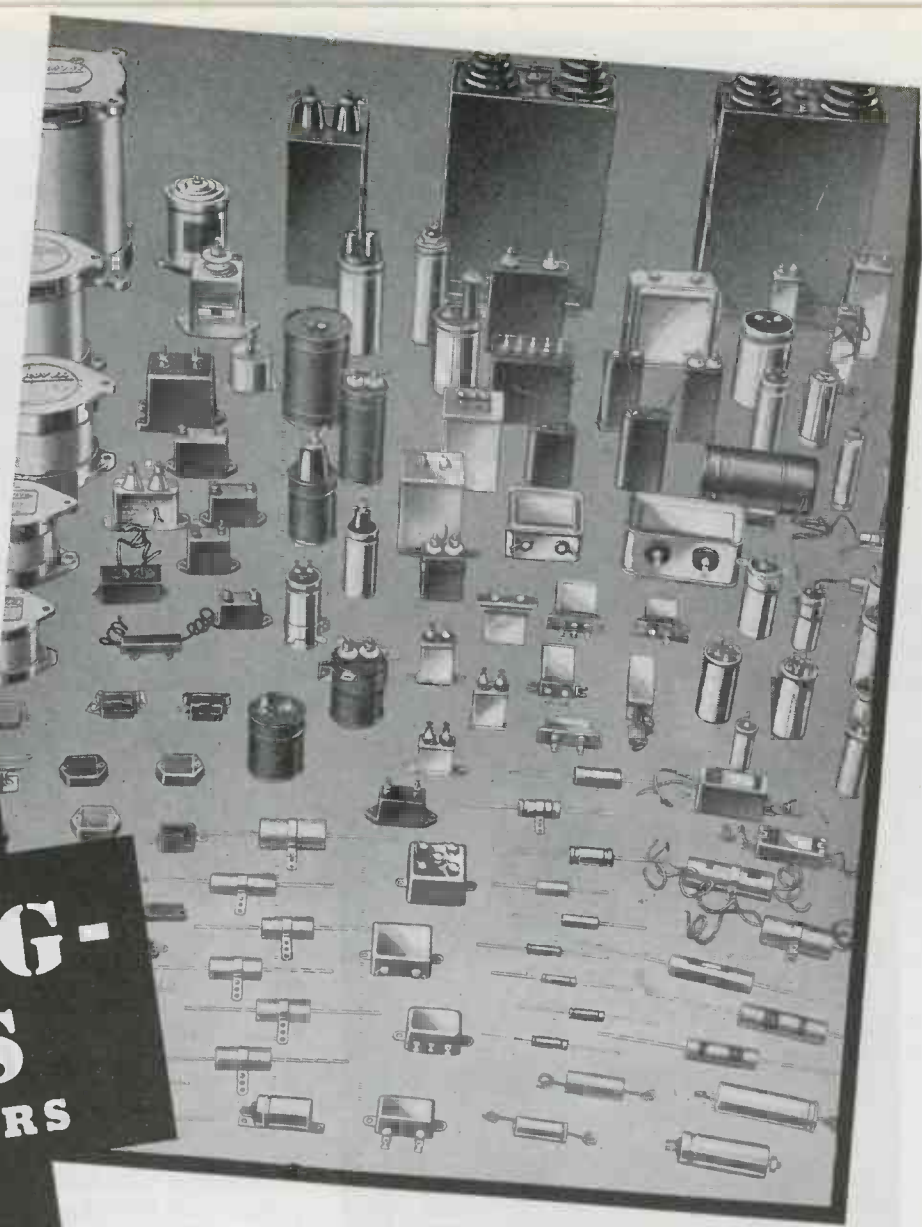

● Critical equipment designers, builders and users are insuring their assemblies with Aerovox *rating-plus* capacitors. That Aerovox extra safety factor is widely recognized today. Service records speak for themselves.

All Aerovox paper-capacitor voltage ratings are for standard temperature, pressure and humidity conditions,

namely, 20° C., 30 inches of mercury (760 millimeters), and 50% relative humidity.

Where Aerovox capacitors are in hermetically-sealed cases, the only effect caused by changes in standard conditions will be in the external flash-over voltage occurring at lower voltages for conditions involving reduced pressure and increased humidity. The capacitor proper remains unaffected.

The maximum operating temperature for continuous operation at rated voltage is 65° C. ambient. If temperature is greater, operating voltage must be reduced. Derating data will be supplied on request.

Yes indeed, it will pay you to look into this matter of Aerovox *rating-plus* insurance. Remember, it costs no more but it can save you much expense and trouble.

● Submit your capacitance problems.  
Literature on request.



# Capacitors

INDIVIDUALLY TESTED

AEROVOX CORPORATION, NEW BEDFORD, MASS., U. S. A.

SALES OFFICES IN ALL PRINCIPAL CITIES

Export: 13 E. 40 St., New York 16, N. Y. • Cable: 'ARLAB' • In Canada: AEROVOX CANADA LTD., HAMILTON, ONT.

ELECTRONIC INDUSTRIES • May, 1945



# Federal ANNOUNCES ITS Industrial Tube Policy

**BECAUSE** of the totally different and unusually severe operating conditions that have to be met by power tubes used in industrial heating equipment

— in installation and maintenance by personnel unfamiliar with vacuum tubes,

— under operating conditions involving extreme variations in load during processing and between operations... the shocks, jars, vibration due to nearby presses, punches, drilling machines,

## Federal ANNOUNCES ITS Industrial Tube Policy

*ALL Federal Industrial Tubes . . .*

- ☞ will be specifically proportioned for industrial use.
- ☞ will have *ample* factors of safety for long life and economy under the severe operating conditions met in industrial service.
- ☞ will be of *rugged mechanical design* to meet the requirements of industrial installation and operation.
- ☞ will carry a *full guarantee* against defective materials and workmanship for 18 months after date of shipment, or 2000 hours effective life\*, whichever occurs first, when operated under rated conditions, as against the 1000 hours effective life\* rating, the common practice in rating ordinary tubes.

\*Federal recognizes that in many industrial applications tubes will be operated with filament power only, for a considerable portion of the time. For this reason effective tube

life will be computed as the sum of the hours with filament and plate power applied, and 20% of the hours with only filament power applied.



# Federal Telephone and Radio Corporation

WF-1283

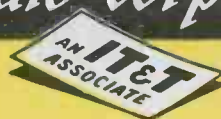

Newark 1, N. J.

*This is the second in a series of four advertisements discussing the four major functions of permanent magnets*

*Speakers*

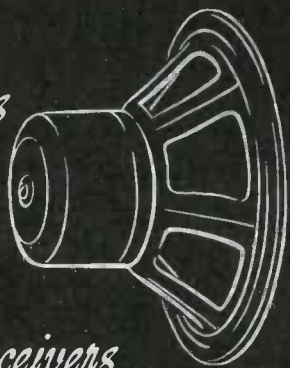

*Telephone Receivers*



*Instruments*

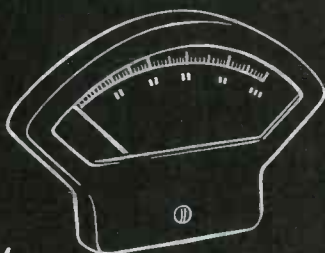

*Electric Motors*

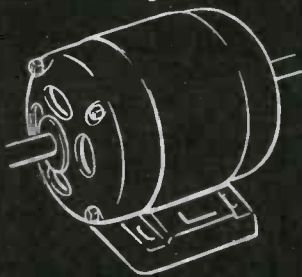

*Polarized Relays*

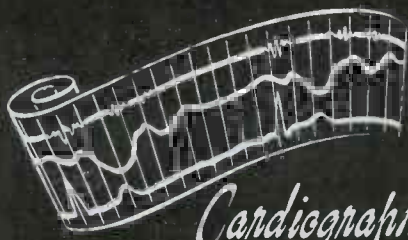
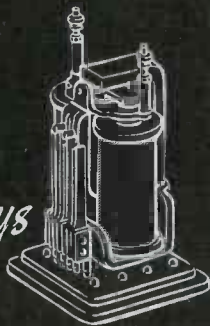

*Cardiograph Recorders*

## MECHANICAL ENERGY from ELECTRIC CURRENT through PERMANENT MAGNETS

The electric motor demonstrates how mechanical motion can be produced by the passage of an electric current with respect to a magnetic field set up by permanent magnets. Industry and science are making many profitable uses of this principle.

Mechanical energy may be transmitted to electrons moving in space to cause them to take a desired direction. A permanent magnet has been used, for example, to change the path of a cosmic ray in a cloud chamber. X-rays may be similarly directed; or the path of electrons in a magnetron tube can be changed.

The permanent magnet may be used as a polarizing agent, remaining stationary while mechanical motion is obtained by varying the magnetic field through variations in the applied electrical energy. Telephone receivers, magnetic recording heads, polarized relays, armature-type loud speakers, and some kinds of vibrators employ this principle.

For specific applications of permanent magnets to your problems of product improvement, consult our engineers. For 35 years we have specialized in the manufacture of permanent magnets and are today the largest plant in the world in this field. Write for copy of free technical booklet: "Permanent Magnets Have Four Major Jobs."

### ★ THE INDIANA STEEL PRODUCTS COMPANY ★

6 NORTH MICHIGAN AVENUE • CHICAGO 2, ILLINOIS



Specialists in Permanent Magnets Since 1910



**YOU'RE  
IN FOR**

**A LOT OF small TALK** after this war, thanks

**to Schweitzer's Thin Gauge papers**

The wartime Walkie-Talkie will become the citizen's Walkie-Talkie... aviation radio... small, light, compact... will develop into new and better portable sets... unique electronic gadgets galore will make this a brave new world. If you are using capacitors or designing equipment where space is a factor, perhaps our .00025" paper, with a tolerance of + or - .000025" may help you solve your problems. When you think of THIN insulating papers... think of Schweitzer.

**SCHWEITZER PAPER CO.** 142 MILLER STREET,  
NEWARK, N. J. • Plants: Newark, Jersey City, N. J., Mt. Holly Springs, Pa.  
Research Laboratories: Chrysler Building, New York, N. Y.

SPECIALISTS IN THIN GAUGE INSULATING PAPERS



# FOR COMPACTNESS

## World's smallest transformer

These units,  $7/16'' \times 9/16'' \times 3/4''$ , are the optimum in small transformer design... they have been in production for five years.



## Weight reduction . . . . 95%

This dual purpose aircraft filter was reduced in weight through UTC design from 550 to 27 ounces.



## Ouncer transformers-Hermetic

Hundreds of thousands of UTC Ouncers have been used in the field. Solder sealed hermetic constructions effecting the same weight and space savings are now in production.



May we cooperate with you on design savings for your applications . . . war or postwar?



ALL PLANTS

# United Transformer Corp.

150 VARICK STREET

NEW YORK 13, N. Y.

EXPORT DIVISION: 13 EAST 40th STREET, NEW YORK 16, N. Y.,

CABLES: "ARLAB"

# ELECTRONIC INDUSTRIES

Including INDUSTRIAL ELECTRONICS

O. H. CALDWELL, EDITOR ★ M. CLEMENTS, PUBLISHER ★ 489 LEXINGTON AVE., NEW YORK (17), N. Y.

## Let's Have a Look!

Advance designing of postwar civilian equipment is vitally needed by the radio-electronic industry.

In order to give reconversion a good start, the military services should now allow the industry a "look" at our secret electronic and radio inventions, to ascertain their adaptability to civilian peacetime uses. This could be done in secret sessions by committees made up of responsible manufacturers in specialized fields of electronic and radio equipment, and officers of the armed services. It certainly would be a step towards hastening the day of new products born out of the war inventions, so that industry would be geared for reconversion.

## Spare Us Dislocation and Unemployment

Reconversion planning will be most difficult unless industry is given an opportunity to be geared to the fullest for carrying on civilian production as soon as the war ends.

Otherwise, it seems pretty likely that we will have a hiatus of considerable unemployment and dislocation. This will give opportunity for the vocal pressure groups to attack industry and advocate measures to maintain employment through government controls and funds.

Without knowledge of the adaptability of wartime electronic-radio developments and inventions, the proper designing and planning for civilian production reconversion will be delayed and hampered.

## One Silver Lining

Industrial managers who learned their radio manufacturing in the pre-war small-shop times have felt cramped by the Labor Board and Treasury rules concerning classification and advancement of employees.

However, we believe they have received some valuable tips on how to keep employes contented. Only a little job analysis and evaluation by a suitable point system is needed in most medium-size companies to set at rest complaints of unequal pay for equivalent jobs. Of course, consistent application of results is required.

## A 50% Cut in Military Electronic Needs?

Those "in the know" about military-navy requirements for the Pacific campaign indicate there may be a 50 per cent cut in military radio-electronic production, after victory is achieved in Europe. While the Pacific War will still require 5 million men for army and air forces (against present two-war 8,200,000), in addition to 4 million in navy, radio-electronic requirements will be slackened off to probably 50 per cent of the demands at outset of 1945. This should free large productive capacity for civilian radio and electronic devices, although components may not be in balance for some time to come.

## For an IRE Headquarters Building

"Every man owes a debt to his profession," said Theodore Roosevelt back in the coherer days of wireless.

Radio men now have an opportunity to liquidate in part that debt, by contributing to the \$500,000 Building Fund to be used to set up a new headquarters for the Institute of Radio Engineers in New York city.

Already a large part of the sum needed has been subscribed, testifying to the value which the radio industry puts upon this movement. But every radio-electronic concern will want to be represented proportionately in the IRE Building Fund. Get your check in now!

## LOOKING AT THE PHYSICAL DIMENSIONS OF MICRO WAVELENGTHS

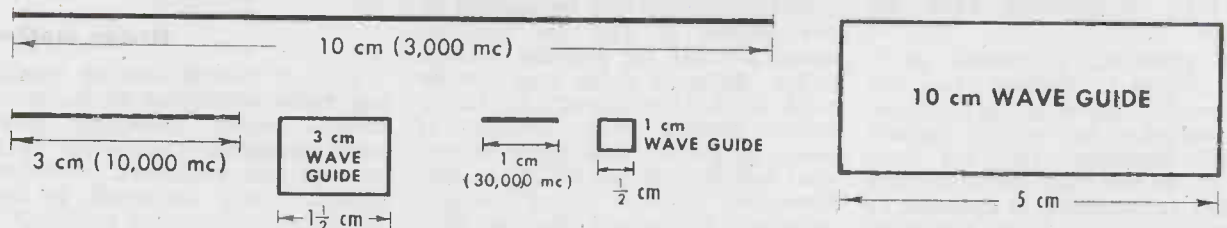

These illustrations, drawn to scale, show the actual lengths of one-, three- and ten-centimeter waves, together with the appropriate sizes of wave guides, and will help in visualizing these high frequencies in terms of ordinary measurement

# OPERATIONAL ELEMENTS

By **WILLIAM E. MOULIC**  
Associate Editor, Electronic Industries

*The scope of applications and basic circuit elements required in Radar transmitter, receiver and antenna array*

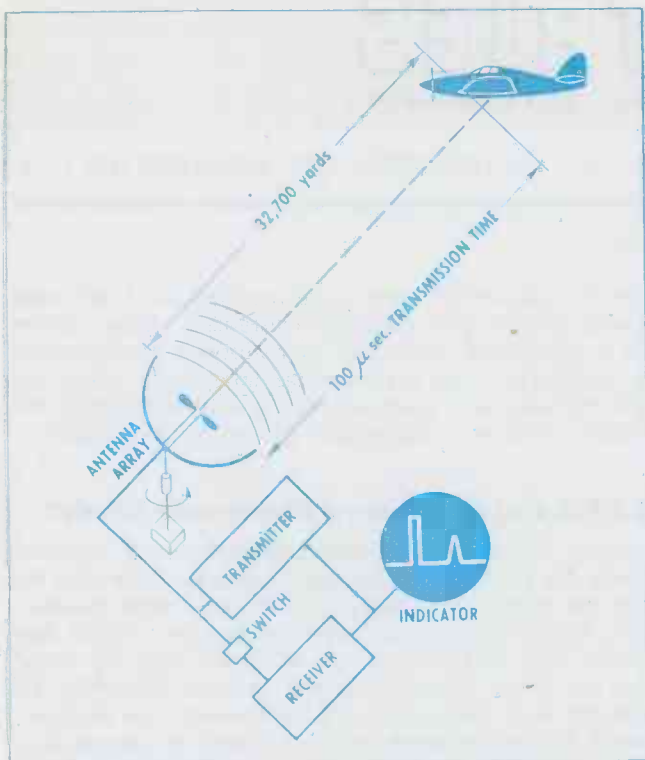

Fig. 1. The elements of ranging and direction finding by radio frequency energy echos. Familiar directional antennas give direction of transmission path to object while elapsed time between initial pulse and echo gives range

● Radar is an application of basic radio principles to the many problems of determining distance between the radar equipment and an object which will reflect radio frequency energy. These same principles employed by radar have been applied to ionosphere height measurements for many years.<sup>1</sup> The ability of radar to determine distance and direction makes it most suitable for detecting the presence of foreign objects, for example, aircraft, ships, mountains, etc. The fundamental principles involved are the constant known speed of the radio wave propagation and the reflection or echo principle so pronounced and characteristic of the ultra-high frequencies (100 mc and up).

The practical usefulness of a radar system is obvious when the ever-present problems of navigation, collision prevention, enemy aircraft detection, etc., are considered. In the example of aircraft location, information is required at greater ranges and "early warning" radar is necessary. This system gives the range and approximate

azimuth, then accurate reporting radar systems permit the location of the target in three dimensions. The available data secured from the radar systems may be used to direct fighter aircraft.

Radar systems can be applied to the control of gun fire and on board aircraft for locating surface ships. Airborne radar may also be used by fighter aircraft to locate enemy aircraft when visibility is poor. A simple basic radar system does not include the ability to differentiate between friend and foe. Auxiliary equipment may be synchronized with the radar apparatus to block the gunfire from friendly craft.

The usefulness of radar as a

navigational aid in the prevention of collisions, and determination of absolute altitude, is very great. Allied superiority in this phase of warfare is perhaps a major factor in the winning of the war.

### Radar methods

Various possibilities of combining radio principles to produce a distant-object detecting system have presented themselves to inventors and engineers. Numerous systems have appeared in both American and foreign patents.<sup>2</sup>

One method of detecting a target by radar makes use of the Doppler effect. When rf energy, transmitted continuously, strikes

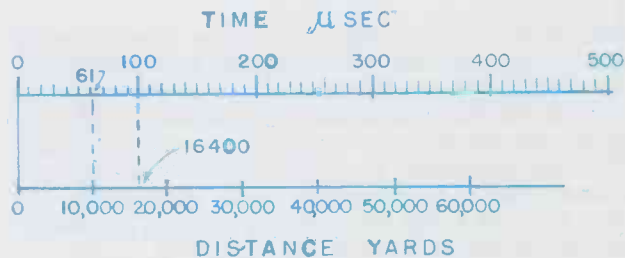
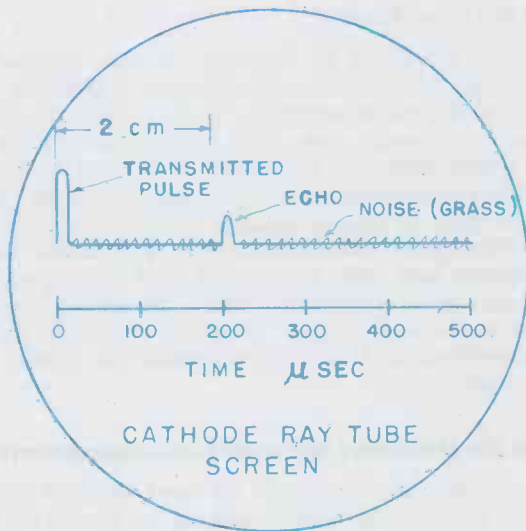

Fig. 2. A possible indicator trace where horizontal position of cathode ray is proportional to time. Initial and echo pulses appear as vertical deflections of beam. Elapsed time-distance scale is based on speed of RF propagation

<sup>1</sup>See Footnotes, page 226.

# OF A RADAR SYSTEM

an object, moving toward or away from the source of energy, part of the energy is reflected and its apparent frequency is changed. This change in frequency (the well-known Doppler effect) is familiar in the case of a train whistle changing its apparent pitch as it moves toward, then away from an observer. In the radar application, the equipment measures the difference in frequency between the transmitted and reflected waves in order to determine the speed of the

The pulse modulation method is the most common in current usage.

The primary advantage of radar is the result of the ability to convert a measured time interval into terms of distance. This is due, of course, to the fact that radio frequency energy radiated into space continues to travel at a constant and known velocity. Upon striking an object, there is no loss of time but merely a reradiation of part of the energy. The velocity or rate of propagation is considered to be that

of light, which travels 327 yds. per microsecond. For example, in Fig. 1, if a  $1 \mu\text{sec.}$  pulse from the transmitter travels toward an object 32,700 yds. away the time required for the pulse to make the trip one way is  $100 \mu\text{sec.}$  The reflection will require an equal amount of time to return and the total will be  $200 \mu\text{sec.}$  Since the radar indicator gives the total elapsed time it is common to figure distances (radar antenna to object) as 164 yds. per microsecond of indicated time between initial and reflected pulses.

Since the fundamental quantity involved is time, the precise measurement of that quantity is essential to the accuracy of a radar system. The cathode ray oscillograph is well suited to the task, since it retains the information on its screen and also provides a time axis or scale.

Assume in the illustration Fig. 2, that the linear sweep of the cathode ray tube is 1 cm per  $100 \mu\text{sec.}$  The initial and any reflected signals which might be received are applied through suitable circuits to the vertical deflection plates of the tube, thus any signal, either initial or reflected, will appear as a vertical "spike" on the CR tube screen.

Consider as an example, that a  $1 \mu\text{sec.}$  duration pulse is transmitted. This pulse will appear on the screen of the receiving CR tube. This pulse will be 0.01 cm wide and during this time the rf energy will have traveled 327 yds. from the transmitter. If the target is 32,700 yds. away the pulse will arrive at the target in the time that the cathode ray spot moves 1 cm and the spot will move an additional centimeter in the same direction during the time the reflected

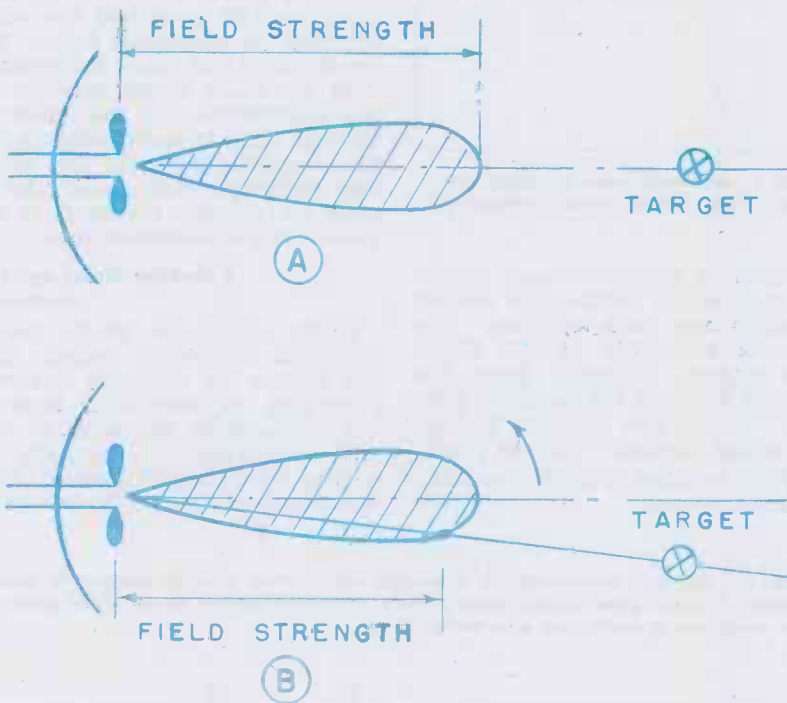

Fig. 3. Direction finding principles of single lobe antenna where amplitude of output voltage is a function of angular position. Direction to object is indicated when output of receiver is maximum. Antennas shown are symbolic and may be any of well known arrays

moving object. This method is best applied to fast moving targets because of the small shift in frequency.

In a system which has been long used for ionosphere measurements, radio frequency energy from the transmitter is pulse modulated for short intervals from 1 to  $50 \mu\text{sec.}$  The pulse ends before the reflected energy returns from the reflecting surface to the receiver, and an indicator is employed to determine the time between the initial and the reflected pulses. The output of the receiver is applied to the indicator, usually of the cathode ray variety. When all reflections have returned, the transmitter can again be pulsed and the process repeated.

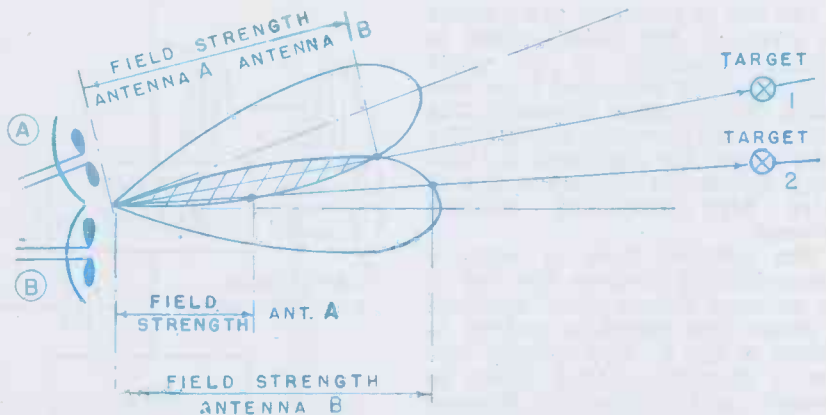

Fig. 4. Lapped antenna reception patterns may be employed for more accurate direction determination as is common in aircraft landing systems. Output of two antenna systems is equal for only one direction (target 1). Other directions give unequal outputs

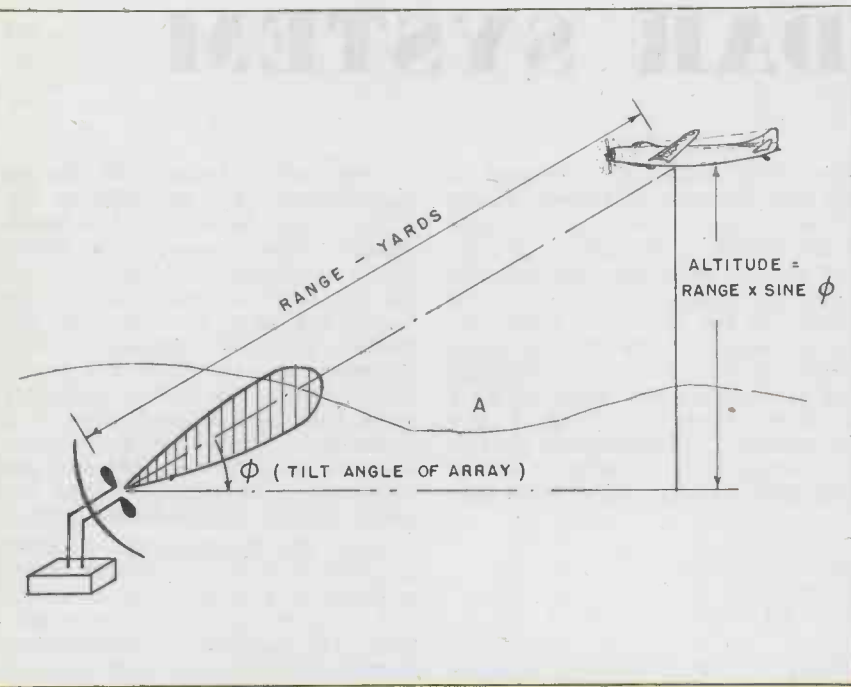

Fig. 5. Simple altitude determinations are possible by measuring range of object and vertical angle of maximum echo strength. Altitude is then a right triangle relationship

An overlapped double lobe antenna pattern could be used where greater accuracy is required. The principle of the double lobe system is indicated in Fig. 4. Two lobes from the antenna system are displaced so as to overlap at one point. At this point equal signals would be produced by the two antennas for this particular azimuth. At all other positions of the array unequal signals would be received by the two antennas involved, and by selective switching or dual reception equipment the bearing of the array could be adjusted until equal signals were picked up by the two antennas.

The elevation of an object can be determined by the slant range and the angle of elevation of the reflected wave. A tilted antenna array can be used and the angle adjusted for maximum signal. The combination of this information with the slant range provides for the calculation of the elevation through right triangle computation. This is shown in Fig. 5. The double lobe pattern system could also be used for greater accuracy in elevation angle measurements.

**Fundamental system elements**

Radar equipment varies greatly in detail depending largely upon the degree of accuracy involved. Principles of operation, however, are substantially the same. In general the degree of accuracy increases with the rf frequency since the microwave region lends itself to

energy returns to the receiver. The reflected pulse will appear on the screen 2 cm from the initial pulse, thus corresponding to 200  $\mu$ sec.

A suitable indicating scale for determining the time interval precisely can be calibrated in yards or other units. Provision is made to synchronize the cathode ray sweep with the initial pulse of the transmitter in such a manner as to superimpose successive initial and reflected waves in order to give a continuous pattern for observation. If more than one object is present at different distances, an echo pulse will appear on the screen for each of the units that can be resolved by the beam angle of the directive reception antenna equipment. A corresponding time-distance scale is also shown in Fig. 2.

**Determination of azimuth**

The line of radiation to an object as given by the radar system is usually presented as an angle which may be measured from true north or any other reference. The azimuth and elevation angles of the echo signal are measured by utilizing directional characteristics of ultra high frequency antenna systems.

The simplest form of azimuth determination involves the use of an antenna system which produces a single lobe radiation pattern as shown in Fig. 3. The antenna system is mounted so that it may be rotated and energy is directed across the region to be searched until a return signal is picked up. The position of the antenna is then

adjusted to give maximum return signal at which position the desired direction may be determined. The azimuth sensitivity of the single lobe system depends upon the angular width of the reception pattern. If the lobe is sharp so that the signal strength changes rapidly with another angular position, accuracy is great.

Fig. 6. Electronic components for a possible radar system showing approximate wave shapes at various points in the circuit. Time  $t_R$  is interval between pulses. Pulse generator connection to oscillograph is for sweep timing

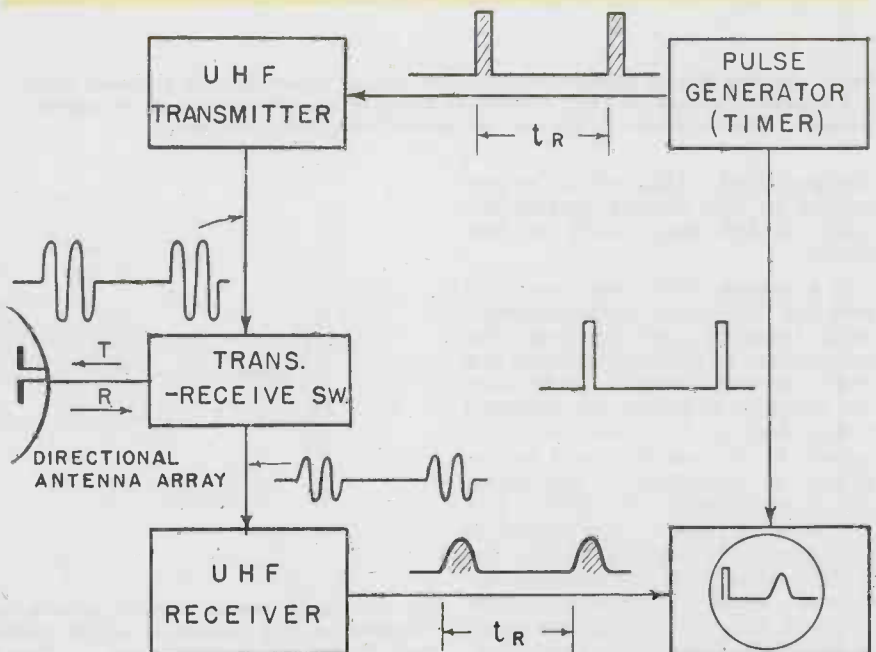



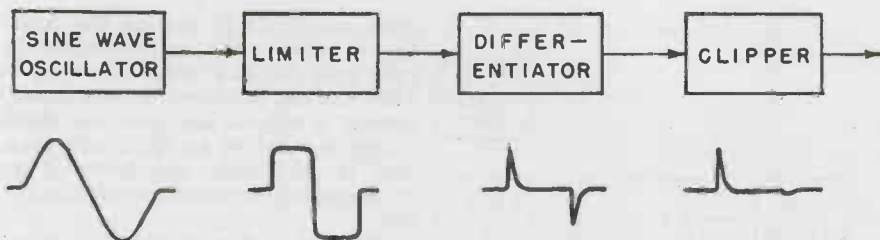
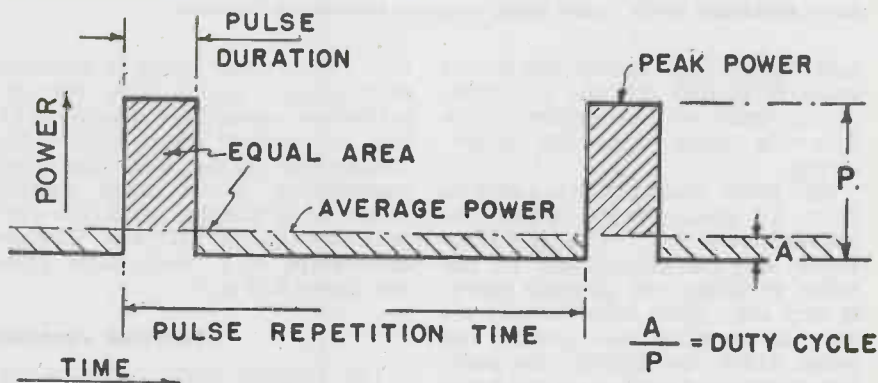

Fig. 7. Common form of pulse generator using wave shaping circuits and differentiator to produce short duration steep front pulses

Fig. 8. Theoretical relations in a rectangular pulse of power. High peak power is possible from tubes and circuits having low average power requirements



greater precision in angular measurements because of the more directional antenna arrays which can be built in a given space.

The functional parts of a pulse modulated radar system resolve themselves into six essential elements. These are shown in the block diagram Fig. 6.

- (1) The timer, also known as the synchronizer, supplies the synchronizing pulses to the transmitter and the indicator.
- (2) The transmitter, which generates the rf energy in the form of short, high peak power pulses under the control of the timer.
- (3) The antenna system, which radiates the rf energy in a directional beam and which receives any returning energy reflected from some given object.
- (4) The receiver, which detects the rf echoes and reproduces them as pulses to be applied to the indicator.
- (5) The indicator, which produces a visual pattern of the initial and echo pulses in such a manner as to deliver the desired information, such as time lapse for range, angular bearing, etc.
- (6) A power supply.

There are several methods for generating the timing or synchronizing signals. The pulse repetition frequency can be determined by a stable oscillator such as a resistance tuned audio oscillator, multi-vibrator or similar type. The output of this oscillator can be applied to wave shaping circuits to produce the required timing pulses. Fig. 7 shows a typical circuit which can be used as a pulse generator. Through the application of famil-

iar grid-blocking phenomena, the transmitter with its associated circuits may establish its own pulse width and pulse repetition frequency and also provide the synchronizing pulse for the other parts of the system. This action may be accomplished in the rf oscillator with properly chosen circuit components. This second timing method eliminates a separate timing circuit; however, the control of pulse width and repetition rate is less accurate.

The carrier frequency selected for radar purposes is a compromise between the directional advantages of very high frequencies and the

difficulties encountered in producing and amplifying these frequencies. The lowest carrier frequency is normally governed by consideration of practical size for the directional antenna array. Frequencies from 100 mc to several thousand are in general use.

#### Pulse rates

The repetition rate of the pulses should be such that sufficient time is allowed for an echo to return from any target within the maximum workable range of the installation, otherwise the reception of pulses from distant targets would be obscured by a repeating initial pulse. In searching, the antenna system is rotated at a constant speed, and the beam energy strikes the target for a relatively short time. During this time a sufficient number of pulses should strike the target and be returned to produce a lasting indication on the oscillograph screen. Therefore, the persistence of the screen and the rotational speed of the antenna ordinarily determine the lowest repetition rate for the pulses.

In a system in which the entire interval between transmitted pulses is used in the indicator the repetition frequency must be very stable if accurate range measurement is desired.

The shortest range at which an object can be located is determined largely by the time duration of the initial pulse. If the target is so close to the transmitter that the

Fig. 9. Possible protective switch for receiver consisting of gas-filled resonant cavities which are short-circuited when transmitter pulse ionizes gas. Principle is similar to neon filled lightning arrestors.

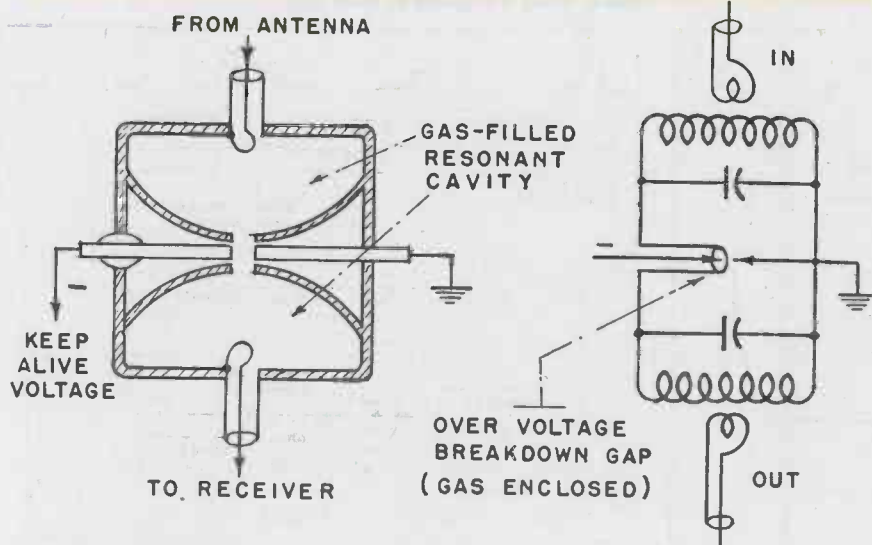

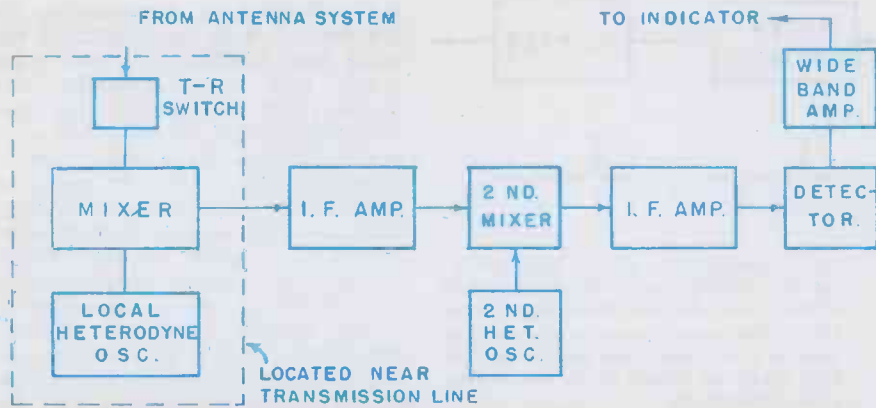

Fig. 10. Block diagram of a suitable UHF superhet for reception of radar echo pulses. High carrier frequencies usually require double frequency conversion as illustrated

echo is returned before the initial pulse is turned off, the reception of the echo will be masked by a following pulse from the transmitter.

The radar transmitter is rated in terms of peak power. Since the transmitter is "off" for a time relatively long in comparison to the pulse duration, the average power is very low. With other factors remaining constant, the greater the pulse width the higher the average power, and the longer the pulse repetition time the lower the average power. Thus:

$$\frac{\text{Av power}}{\text{peak power}} = \frac{\text{pulse duration time}}{\text{pulse repetition time}}$$

The ratio of pulse time to repetition time is called the duty cycle. For example, a 1  $\mu$ sec. pulse repeated 1,000 times per second has a duty cycle of  $10^{-3}$ . The ratio of the average power to the peak power is likewise equal to the duty cycle. Thus for an average power of 100 watts a peak power of 100 kw would be obtained with a duty cycle of

$10^{-3}$ . High peak power is desirable to produce a strong echo over the maximum range of the equipment. The low average power enables the transmitter tubes and associated components to be made smaller which is in keeping with the current state of the UHF art. The relationships in a rectangular pulse are shown in Fig. 8.

#### Antenna systems

The simplest radar antenna system would contain two separate arrays, one for transmitting and one for receiving. The receiving antenna would be shielded from the transmitter to protect the receiver from the powerful pulses. In general the directivity pattern is sufficiently sharp to permit close operation.

A more practical system involves a single antenna and an antenna switch capable of transferring the array from transmitter to receiver and back again at the pulse repetition frequency. Such a switching arrangement has long been com-

mon, particularly among the amateurs. Since the pulse repetition rate may be any value from 60 to 5,000 cycles, however, a mechanical switch is out of the question. Such a switch must be an electronic type, and it may take the form of an rf amplifier, resonant transformer, etc.

When a radar receiver is operated in close proximity to the radar transmitter a certain amount of signal inevitably gets in the receiver through stray fields. In such instances these stray signals resulting from the main transmitted pulse must be eliminated from the output of the receiver. This is accomplished by turning off or "gating" the receiver. It is usually necessary to couple a small amount of transmitted rf energy into the receiver for timing purposes. It is important to prevent damage to the receiver as a result of the powerful pulse and likewise to prevent blocking of the receiving tubes during transmission.

A common form of transmit-receive switch embodies some of the principles of the old gas-filled antenna switch for lightning protection. The general arrangement is shown in Fig. 9. The device consists of a pair of coupled resonant circuits (in the form of cavities) shunted by a discharge gap. The cavities are sealed and gas filled. An electrode system across the narrow cavity coupling gap is charged and used to keep the gas at a near-ionization state. When the transmitter is pulsed, the rf voltage surge fed to the input cavity ionizes the gas and thus forms a virtual short across the circuit. In the equivalent circuit at the right in Fig 9, it is seen that any discharge

(Continued on page 225)

Fig. 11. Television scanning raster could be employed to combine two elements of target position even as it is for picture element location. Grid modulation of CR tube by signal produces bright spots on coordinate system of desired factors

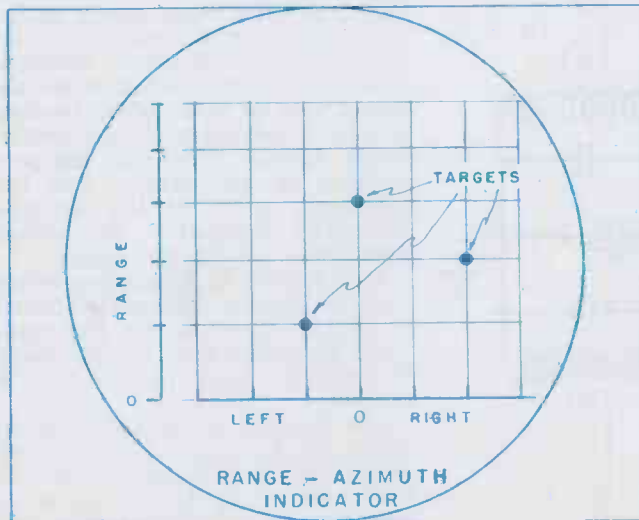
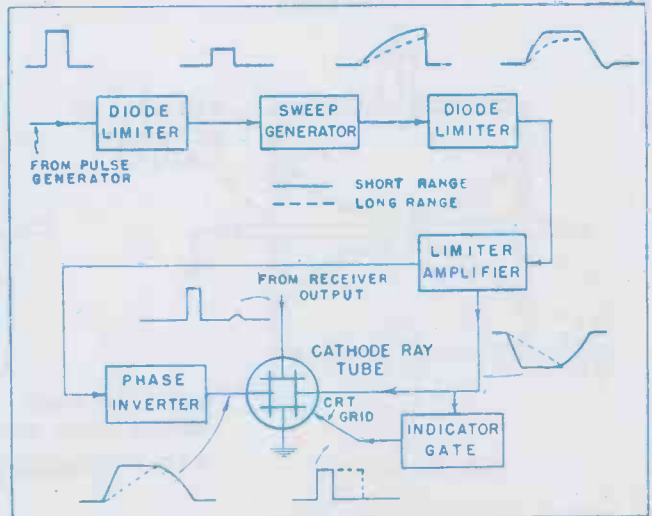

Fig. 12. Circuit elements of a pulse indicator with typical wave shapes at several points. Note the similarity to television sweep and synchronizing circuits. Two-range sweep wave shapes are shown. Sweep is triggered by timer pulse



# RAILROAD RADIO

*Two-way Motorola FM installation on fast Diesel freight train connects engineer and caboose and cuts 3 hours off running time in 570 miles*



1—Installation in the caboose of the "Flying Ute," crack Denver & Rio Grande Western freight train during test run between Denver and Salt Lake City, showing speaker and control panel

2—Antenna at the caboose end of the 65-car train was mounted on the side of the car and consisted of two half wave radiators in phase



3—Henry Koll engineer of the Galvin Mfg. Co., which made the installation, makes final tuning adjustments on the equipment before test run

4—Part of the installation in the engine cab as engineer checks train orders with conductor before clearing the yards on run to Salt Lake City



5—Gasoline engine driven generator which provided 117-volt ac to power the equipment installed in the caboose. For the engine installation power was obtained from a converter driven from the starter batteries; provided 32 to 117 volts



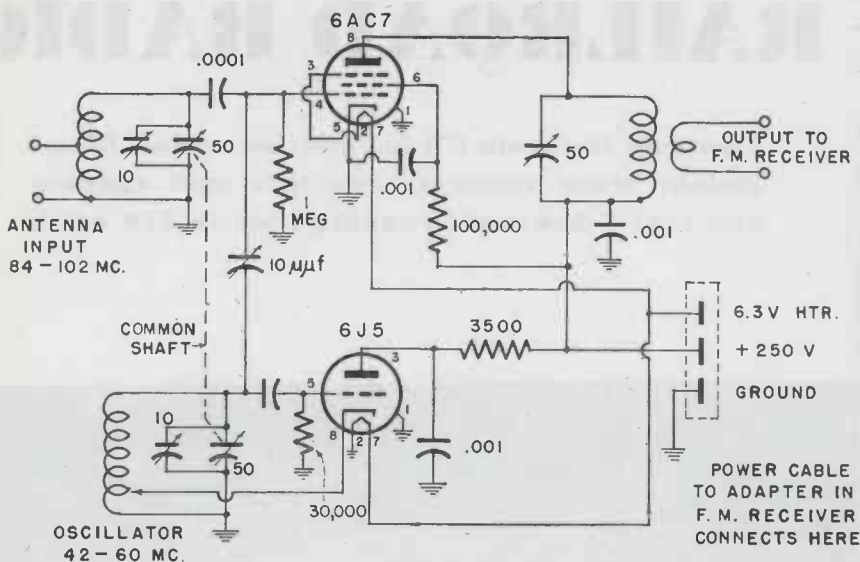

Circuit diagram of the 2-tube FM converter designed and built by the Field Division engineers of the Federal Communications Commission, and a photograph of the finished equipment as demonstrated with a Stromberg-Carlson AM-FM receiver

# SIMPLE FM CONVERTERS

FCC engineers design two tube and Hallicrafters produce one and three tube units to extend FM receivers to 80-102mc

● In order to demonstrate that a reasonably priced converter can be used to convert an FM receiver geared to the present 42-50 megacycle band so that it can receive programs in the projected "upstairs" 84-102 megacycle band, the Federal Communications Commission's Field Engineering Division constructed a converter out of parts purchased over the counter in Washington, D. C., radio retail stores at a total cost of \$8.85. The FCC Field Division's Laboratory at Laurel, Md., has since constructed a converter for the same purpose which with one tube operation can be built into a receiver and not be a separate detached portion of the receiver.

### Models demonstrated

At the same time, the FCC through its Field Division Chief, George S. Turner, demonstrated before a group of radio trade paper correspondents, including the Electronic Industries Washington Bureau representatives, a converter manufactured by the Hallicrafters Co. The Hallicrafters Co. estimated that it could sell a three-tube converter of this type with built-in power supply for \$11 and a single

### FM CONVERTER COSTS

(Present-day prices at retail in small lots, as compiled by FCC Engineers)

Quantity	Description	Price
1...	Tube, type 6AC7 (1852).....	\$1.12
1...	Tube, type 6J5.....	0.50
2...	Wafer octal sockets..... @ 0.05..	0.10
1...	Dial, vernier.....	1.00
1...	Metal box and chassis (blank).....	1.73
2...	Antenna terminal strips..... @ .10..	0.20
1...	Adapter, octal (4 ft. 3-wire cable). (Est.)	0.40
1...	Dial light bracket, with jewel and bulb.	0.25
1...	Variable condenser, 2 gang, 6-50 mmfd..	2.00
4...	Trimmer condensers..... @ 0.10..	0.40
3...	Inductances, hand wound of hook-up wire....	
5...	Condensers, mica..... @ 0.12..	0.60
2...	Carbon resistors, 1 watt..... @ 0.06..	0.12
2...	Carbon resistors, 1/2 watt..... @ 0.05..	0.10
1...	Lug strip, 3 connector.....	0.04
2...	Lug strips, 1 connector..... @ 0.02..	0.06
3 ft.	Rubber parallel lamp cord.....	0.06
2 ft.	Push-back hookup wire.....	0.02
	Misc. Nuts, bolts, lock washers.....	0.15
<b>TOTAL COST</b> .....		<b>\$8.85</b>

Chassis view of the single tube Hallicrafters FM converter intended to be built in

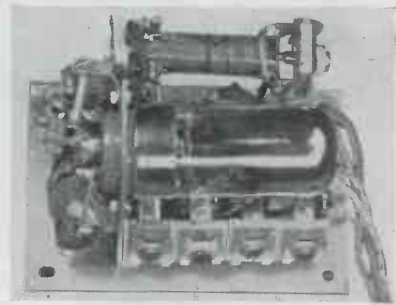

tube fixed wide band converter at as little as \$5.60.

### FCC two-tube

The FCC separate converter unit consists of a 6AC7 first detector and a 6J5 oscillator arranged to operate into the standard FM receiver as an if amplifier. (At Mr. Turner's demonstration the converters of the FCC and Hallicrafters were used with a Stromberg-Carlson receiver, AM-FM combination; and reception came from the FCC experimental FM transmitter and the Jansky & Bailey station W3XO in Washington both using transmissions in the 94 mc range.)

The three-tube Hallicrafters model which was demonstrated by the FCC in Washington uses a type 7V7 mixer, a type 7A4 oscillator, and a type 6X5GT/G rectifier. The output of the converter is fed into the antenna connections of the FM receiver which is tuned to 42 megacycles. The converter oscillator is arranged to track 42 megacycles below the mixer frequency and the entire device simply acts as the front end of a superheterodyne, using the FM receiver as an if amplifier. Devices similar to this have long been used by the amateurs to

receive VHF signals on standard communications receivers.

The experimental three-tube model is larger than necessary as it was built into a chassis and cabinet that happened to be available in the laboratory and is in no sense a finished product. In response to an inquiry from the Commission, Hallicrafters made a careful estimate of costs and said that this model could be built for \$11 fob Chicago, whenever the priority situation permits. This price assumes quantity sales to a single customer and does not include any Federal or State excise taxes.

### **Built-in model**

Of far greater appeal to the present FM set owner, however, is the Hallicrafters one-tube model which can be placed inside the cabinet of practically any FM set. This development makes use of a single type 7S7 tube and all tuning is done with the regular receiver dial. It can easily be installed by any service man or by the set owner himself and only requires that one hole be drilled in the front of the receiver to accommodate the control switch. A universal mounting bracket is provided and power is taken from an adapter plug which is placed under one of the receiver's output tubes.

With this one-tube model the rf input goes to a band-pass filter instead of the usual tuned circuit and the oscillator section is operated at a fixed frequency. The panel switch has three positions, one connects the antenna directly to the receiver to permit normal operation while the other two connect different values of capacity in the band-pass and oscillator circuits of the converter. The FM receiver is used as a variable if and with two fixed frequencies of the oscillator selected by means of the control switch covers the new range of 84 to 102 megacycles in two bands.

### **Drift problems**

Hallicrafters' experimental FM station, W9XHB, is now in operation on 100 megacycles and it is planned to demonstrate the new converter to the public in the near future. The price of this one tube model, fob Chicago, based on quantity sales is \$5.60. This will permit retail sales at well below \$10, which was the figure originally given in Hallicrafters' testimony.

At the recent closed session of military, FCC and industry propagation experts, it was testified that there was no difficulty noted in the converters, including the FCC unit, with the problem of drift in the

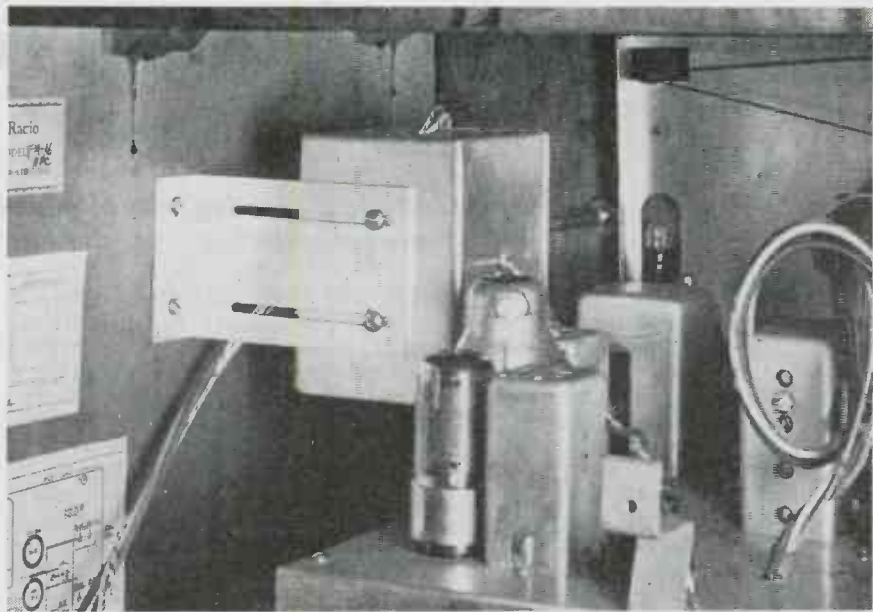

Appearance of the Hallicrafters one-tube FM converter as it would be built into a typical prewar FM console type receiver, the entire unit being enclosed in the rectangular can fastened at the side of the cabinet with a bracket

This is the miniature Hallicrafters single tube converter unit complete with mounting bracket, power take-off plug, etc. The knob is a switch to connect the antenna directly to the FM set for normal operation, with two additional points to connect different values of capacity in the band-pass and oscillator circuits of the converter. Tuning is done with the regular receiver dial on the FM receiver

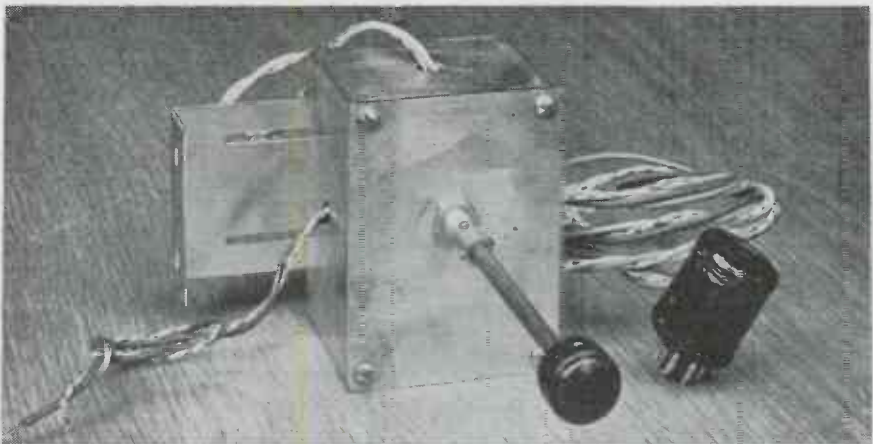

higher FM frequencies, but in order to assure reliable operation the engineers stressed components must be of reasonably good quality. Mr.

Turner felt that the converters could be installed by the receiver owner if he were of a mechanical bent but could easily and with little cost be placed in operation by a radio service man.

This is the three-tube version of the Hallicrafters FM converter in experimental form

FCC Chairman Porter in the closed session—and this portion of the secret hearing has been released—suggested that the present FM broadcasters, if the FM broadcasting assignment were shifted higher, could advise receiver owners as to how they could obtain these converters at reasonable cost just as standard broadcasters have in the past protected listeners by the installation of wave traps. He felt that this would solve the FM receiver problem without any great burden on the public.



# MEETING SPECS in UHF

By H. GREGORY SHEA  
Associate Editor, Electronic Industries

## Strong quality control organization is needed in manufacturing precision microwave equipment

● As the manufacture of electronic equipment expanded under the demand of the Armed Services, many concerns previously of glorified service shop size rapidly became large radio manufacturers. At the same time, their quality problems increased even faster.

Chief of the reasons for this, obviously, has been the rigorous requirements of the Army and Navy. In addition, however, all the old line suppliers of components, swamped with orders, were forced to expand tremendously, with consequent quality problems of their own. Also, many new inexperienced component makers were brought into the industry, many newly designed parts had to be made and perhaps most important, the constant reduction in the length of the radio waves themselves down to fractions of an inch caused a simultaneous reduction in mechanical tolerances.

The practice of testing components as they came into the factory was, in many places, substantially non-existent before the

war. The method used was either to buy on preliminary sample with no further tests, or merely to submit one of the first lot to be shipped to the design engineer for his approval. While this method was suitable for the requirements at that time, it broke down badly under present conditions, creating endless production line troubles and delays. Furthermore, such a practice together with similar methods used on the production line, quickly created irritation and lack of confidence in the personnel of the Army and Navy Inspection Service, causing them to lean over backwards in areas of discretion.

The problems presented here have for some time been solved by larger manufacturers of electrical and mechanical equipment particularly where high quality merchandise was required. Their solution has been to set up a department of people whose sole concern it would be to maintain the quality of the manufactured product. Naturally, all inspection costs money, and the correct amount of inspec-

tion to set up for any situation is the one that produces the lowest cost per dollar of sales revenue, taking into consideration all factors such as production delays and delivery failures. The solution of this economic equation is difficult to give in general terms, as each manufacturer must make his own solution depend on the type of work he is doing and the quality and training of personnel available to him.

### Functional organization

One of the problems of some concern to radio manufacturers at the present time, is whether they should divide an organization functionally or by jobs. While a full discussion of this problem is outside the scope of this article, it may be of interest to note here that the quality control department described in the following text is functional and was put into operation in a company having somewhat less than a thousand employees and running four or more jobs at once. Production lines were geared to make 100 to 400 complex equipments per month operating in all frequency ranges.

It seems almost needless to say that the program for such a department should be in charge of a competent executive type of engineer with experience in both electrical and mechanical manufacturing.

The work of the quality control department falls almost naturally into several sections. These are: (a) incoming inspection; (b) visual or line inspection; (c) electrical testing and test equipment design; (d) construction and maintenance.

All material should be passed through the control of the incoming inspection section. If any one else in the plant has power to decide that certain items need not be inspected, control is lost and incoming inspection can no longer be held responsible for material used in the product.

The person in charge of this section bears a considerable amount of responsibility for the smooth and successful operation of the production line. He should preferably be an engineer with manufacturing experience and a good knowledge of radio parts, electrical and mechanical testing methods and knowledge

Fig. 1—Organization of department should be simple and have clear lines of authority

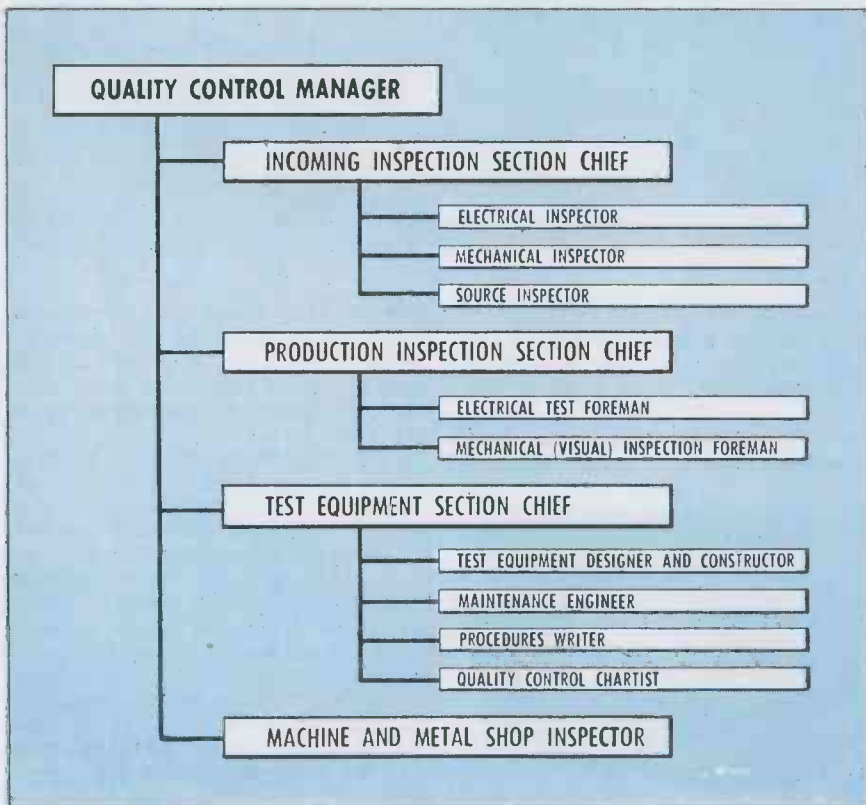

of the principles of modern statistical analysis. With a large quantity of items arriving each day, he will establish routines on certain classes of components such as screws, ordinary resistors, condensers, potentiometers, but will still be faced with making many quick decisions as to the exact nature, amount and kind of inspection to apply.

For example, a case comes to mind in which the exact temper of beryllium copper springs was not specified on the drawings. After assembly, the springs took a permanent set and consequently the finished units, large antenna switches, were rejected. A smart incoming inspector would have held up the item for clarification of the drawing and thereby saved a thousand dollars of re-work expense.

A good deal of equipment for measurement and testing should be available in this section. Only a small part—such items as a high potential test cabinet, percent limit bridge, volt-ohm-meter, Q meter—will be in constant use but other items should be kept nearby. If mechanically precise parts are bought, a fairly complete gage laboratory must be available. There is no use ordering parts to fine tolerances if these cannot be determined when the parts are received. In many cases a complete survey of gaging requirements must be made months in advance of the receipt of material, and adequate inspection gages designed and built.

The question of what percentage of inspection should be used must be approached very practically. An understanding of the supplier's method of making the component is helpful. Unfortunately many parts used in the UHF field are built up by hand from sections of brass tubing soldered to flanges which have been turned out on a

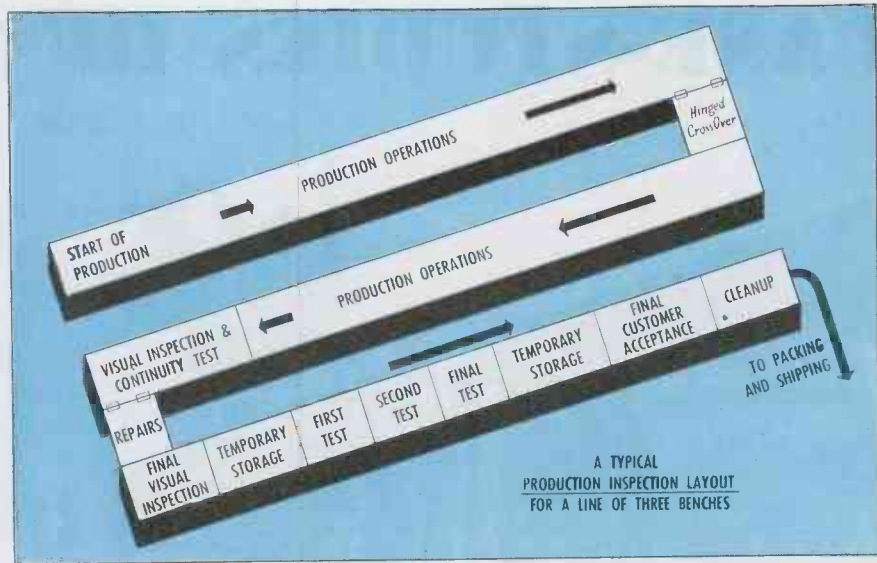

Fig. 2—Enough room for inspection, testing and repair operations should be planned

lathe. The whole may then be silver plated and afterwards must meet close tolerances. Almost no uniformity can be counted on in such cases and each part must be completely measured. On the other hand duplicate die or screw machine parts can be sampled successfully.

Source inspection is expensive of course and is to be avoided if possible. On some subcontracts it is almost necessary however, as in some radar components electrical effects result from mechanical deviations which cannot be measured on the finished component. An example of this kind would be high standing wave ratios in wave guide to co-ax cable couplings due to misplacement of the pick up probe.

While it is difficult, in view of varying conditions to set an estimated figure on the cost of operating an incoming inspection section of the type described, it might be mentioned as a guide that for

really thorough inspection service involving precision in both electrical and mechanical parts, a figure of 1 per cent of purchased material cost should be realized and could probably be bettered by good industrial engineering practices.

As the material begins to appear on the production floor in the form of partial or final assemblies it must be visually inspected for quality of soldered joints, tightness of screws, freedom of operation of gears, lead screws and other moving parts and sometimes degree of backlash. Lastly, if any sort of quantity of production is involved it will be found economical to run the equipment through a continuity checker.

This visual or "mechanical" inspection, of course, is very easy to overdo on a production line, and in general, the ratio of inspection to production employees should not exceed one to seven. If it can be

(Continued on page 226)

Fig. 3—Sudden movement of line outside of dotted control limits indicates trouble

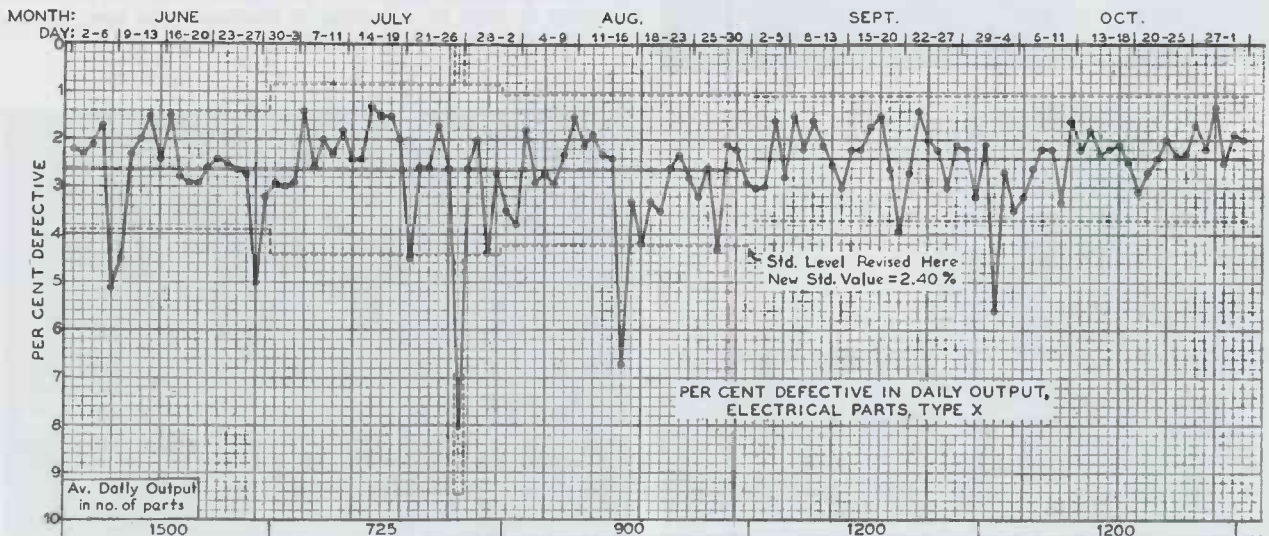

# CASE-STUDIES OF TYPICAL

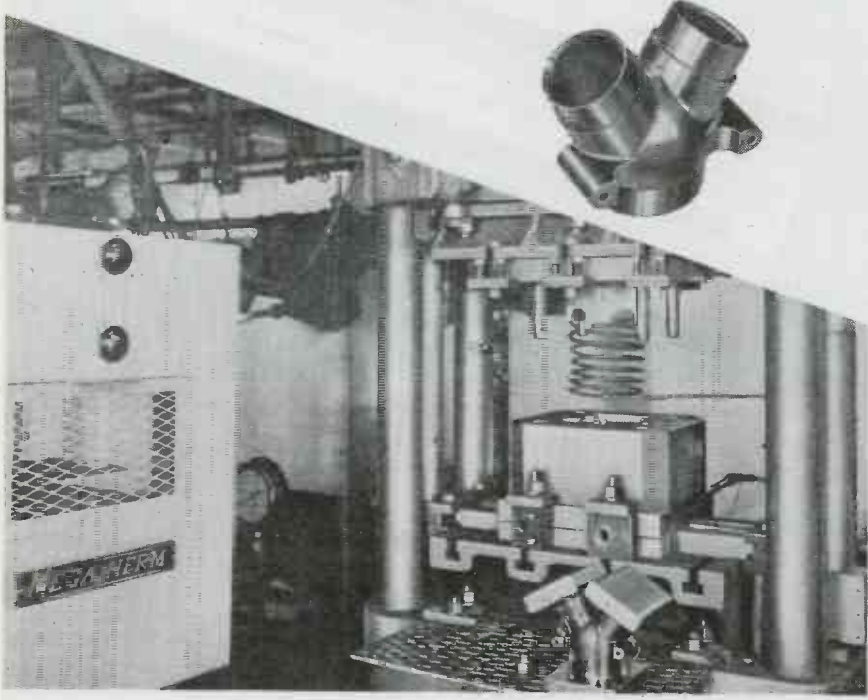

*Modern methods of using high frequency heating equipment in intricate manufacturing operations*

**PREFORM HEATING OF COMPLEX RAG FILLED RESIN BONDED COUPLING** by HF electrostatic field permitted successful production at Kuhn & Jacob Molding & Tool Co., Trenton, N. J. Attempts to mold with other methods of preform heating failed

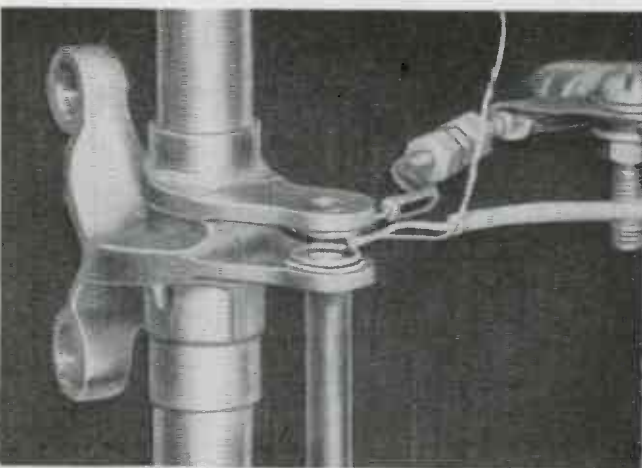

**SURFACE HARDENING IN DIFFICULT SPOT** (left) to a depth of only .020 in. without effect on other parts by means of two coils. Self quenching occurs because of small area getting heat

**CASE HARDENING OF A SHEAVE HUB** (lower left) in a 25 kw production set up to depth .020-.125 in. The part, of SAE-1040 steel, is hardened to 40-45 Rockwell-C by supporting on a ceramic insert on the platform for two seconds. Solenoid then releases work into a quench bath. Another coil outside hub is used to braze it to sheave face

**BUTT-END BRAZING** (below) of loud speaker yokes by six second application of three kw HF energy is illustrated. The joint is amply strong to withstand a subsequent reaming operation

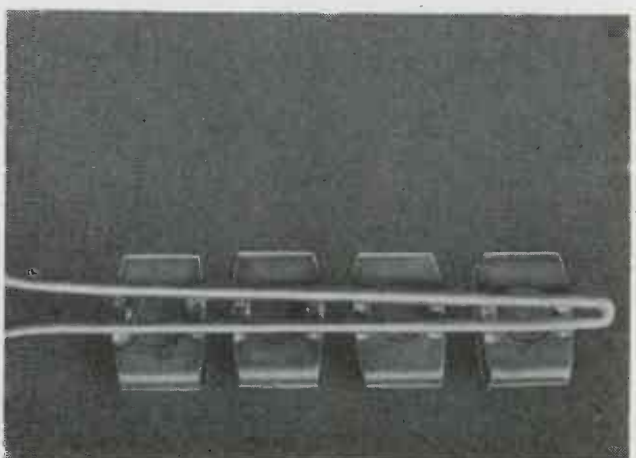
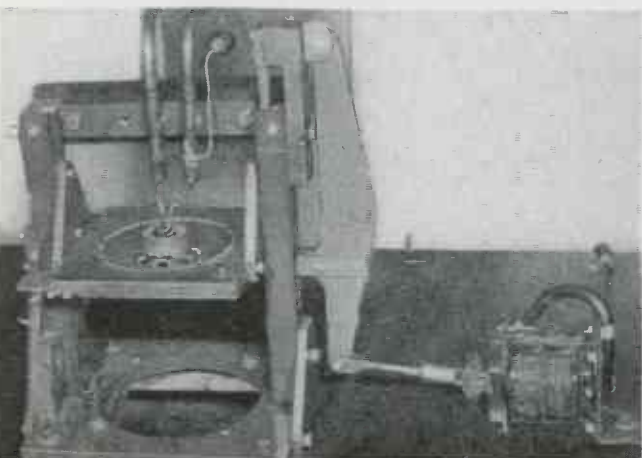



# ELECTRONIC Heating JOBS

*These solutions to typical production problems were worked out by the Industrial Electronics Division, Federal Telephone & Radio Corp. (IT&T associate), Newark, N. J., using Megatherm high frequency heating equipment.*

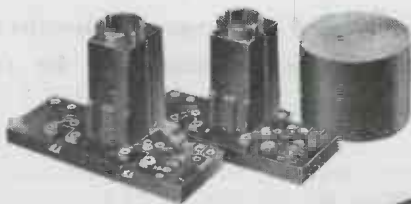

**MEGATHERM DIELECTRIC HEATING** of this intricate plastic part with many metal inserts solved knotty production problem. Uniform temperature throughout obtained in preform allowed reduction in mold closing pressure from 120 tons to 37 tons. Quality improved

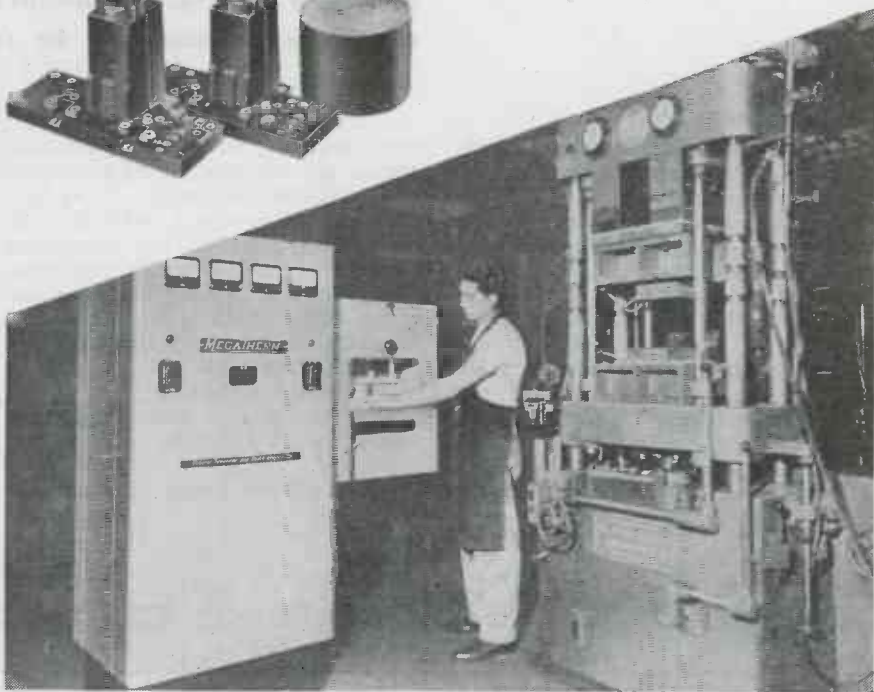

**CONDENSER ROTOR PLATES ARE FLASH SOLDERED TO SHAFT** (right) by a short pulse of megacycle energy. The current is carried by two straight conductors  $\frac{1}{8}$  in. from the shaft. The job is completed before heat can flow off into holding jig

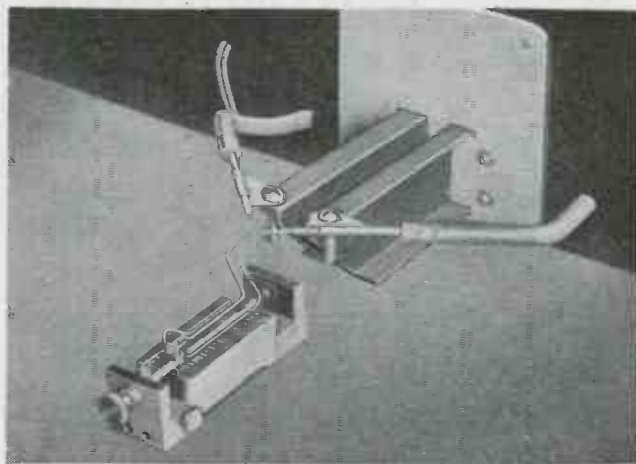

**BRAZING A CUP TO AN OUTER SHELL** (lower right) is accomplished in seconds by induction heating. In this case the coil of copper tubing mounted at the top delivers the energy from the Megatherm

**SOLDERING CADMIUM-PLATED SOFT IRON SPEAKER YOKES TO STEEL MAGNET PLUGS** (below) by a hairpin coil insulated from the work and fed three kw of mc current. This avoids distortion in joining large areas, a hard job

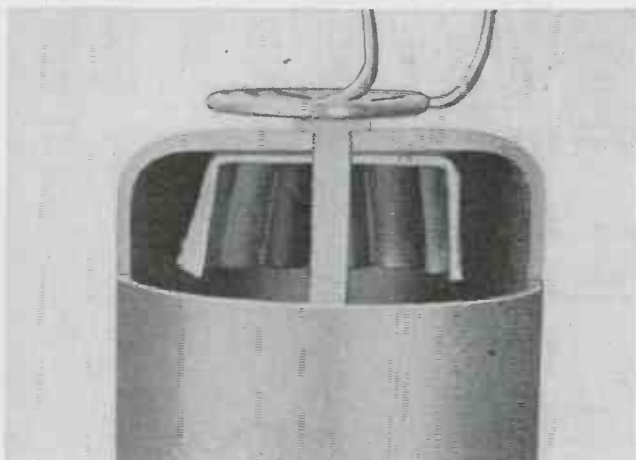
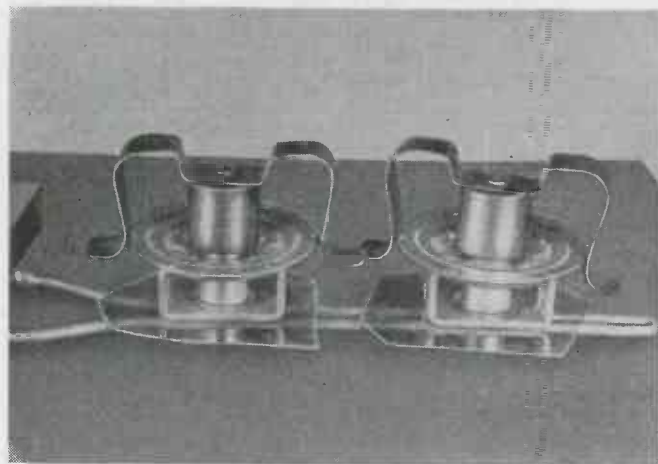

# TUBE CHARACTERISTICS

*Grouped listings of modern types for circuit functions that are commonest in television and FM receivers*

• The choice of tube types for FM-AM receivers, television sets and other electronic devices is influenced by a number of factors. The electrical characteristics of the tubes are perhaps the most important factor, though size and weight are often necessary elements to be considered. The circuit designer has a wide choice of tubes available to him and in general many of the important electrical characteristics are duplicated at least substantially in several physical styles.

The tube types listed below have

been grouped for circuit functions which are commonest in television and FM-AM receivers. They are mainly prewar types with the exception of some of the miniature tubes and probably are the most likely choices for conventional civilian radio equipment. The tubes are suitable at frequencies up to approximately 100 mc, although some of the oscillators, particularly in the loctal and miniature categories, will function at several times this figure.

It should be noted that all the

tubes listed are designed for 6.3 volt heater operation and only the heater current is listed for each type. The chart is not intended for design purposes but merely as a convenient comparison of these commonly used types.

For high frequency operation of oscillators and amplifiers the double cathode lead construction of certain types is an important advantage in reducing effective cathode lead inductance with consequent grid input loading. Tubes having this construction are so marked.

Circuit Function	Type Number	Construction	DIMENSIONS IN INCHES—MAX.			Heater Amps.	Plate Volts	Grid Volts Neg.	Screen Volts	Plate Ma.	Screen Ma.	Plate Resist. Meg-ohms	Trans-conductance $\mu$ mhos	Cut-off Volts Neg.	CAPACITANCES $\mu$ F		
			Overall Length	Seated Height	Dia.										Grid to Plate	Input	Output
High Transconductance R-F Amplifier	6AC7GT	G	3.31	2.75	1.31	0.45	300	2	150	10.0	2.5	1.0	9000	6.0	0.015	11.0	5.0
	6AC7	M	2.62	2.06	1.31	0.45	300	2	150	10.0	2.5	1.0	9000	6.0	0.015	11.0	5.0
	7G7	L	2.78	2.25	1.18	0.45	250	2	100	6.0	2.0	0.8	4500	6.0	0.007	9.0	7.0
	16AG5	Mi	2.12	1.87	0.75	0.3	250	2	150	7.0	2.0	0.8	5000	8.0	0.025	6.5	1.8
Remote Cut-off R-F Amplifier	6K7G	G	4.46	3.90	1.56	0.3	250	3	100	7.0	1.7	0.8	1450	42.5	0.007	5.0	12.0
	6SK7GT	B	3.31	2.75	1.31	0.3	250	3	100	9.2	2.6	0.8	2000	35.0	0.005	6.5	7.5
	6SK7	M	2.62	2.06	1.31	0.3	250	3	100	9.2	2.6	0.8	2000	35.0	0.003	6.0	7.0
	7A7	L	2.78	2.25	1.18	0.3	250	3	100	9.2	2.6	0.8	2000	35.0	0.005	6.0	7.0
9003	Mi	1.81	1.56	0.75	0.15	250	3	100	6.7	2.7	0.7	1800	45.0	0.01	3.4	3.0	
Sharp Cut-off R-F Amplifier	6J7G	G	4.46	3.90	1.56	0.3	250	3	100	2.0	0.5	1.0	1225	7.0	0.007	4.6	12.0
	6SJ7GT	B	3.31	2.75	1.31	0.3	250	3	100	3.0	0.8	1.0	1650	8.0	0.005	6.3	10.0
	6SJ7	M	2.62	2.06	1.31	0.3	250	3	100	3.0	0.8	1.0	1650	8.0	0.005	6.0	7.0
	7C7	L	2.78	2.25	1.18	0.15	250	3	100	2.0	0.5	2.0	1300	8.0	0.007	5.5	6.5
6AK5	Mi	2.12	1.87	0.75	0.175	180	2	120	7.7	2.4	0.7	5100	12.0	0.01	4.3	2.1	
Pentagrid Converter (Char. for mixer sect. only)	6A8G	G	4.46	3.90	1.56	0.3	250	3	100	3.5	2.7	0.36	550	35.0	0.26	9.5	12.0
	6SA7GT	B	3.31	2.75	1.31	0.3	250	2	100	3.5	3.0	1.0	450	35.0	0.5	11.0	11.0
	6SA7	M	2.62	2.06	1.31	0.3	250	2	100	3.5	3.0	1.0	450	35.0	0.13	9.5	12.0
	7A8	L	2.78	2.25	1.18	0.15	250	3	100	3.0	3.2	0.7	550	30.0	0.15	7.5	9.0
Duodode Triode (Char. for Triode sect. only)	6Q7G	G	4.46	3.90	1.56	0.3	250	3	—	1.0	—	0.058	1200	—	1.5	3.2	5.0
	6SQ7GT	B	3.31	2.75	1.31	0.3	250	2	—	0.9	—	0.091	1100	—	1.8	4.2	3.4
	6SQ7	M	2.62	2.06	1.31	0.3	250	2	—	0.9	—	0.091	1100	—	1.6	3.2	3.0
	7C6	L	2.78	2.25	1.18	0.15	250	1	—	1.3	—	0.1	1000	—	1.4	2.4	3.0
6AQ6	Mi	2.12	1.87	0.75	0.15	250	3	—	1.0	—	0.058	1200	—	1.8	1.7	1.5	
Triodes	6J5GT/G	B	3.31	2.75	1.31	0.30	250	8	—	9.0	—	0.0077	2600	—	3.8	4.2	5.0
	6J5	M	2.63	2.06	1.31	0.30	250	8	—	9.0	—	0.0077	2600	—	3.4	3.4	3.6
	17E5	L	2.78	2.25	1.18	0.15	180	3	—	5.5	—	0.0120	3000	—	1.5	3.6	2.8
	6J4	Mi	2.13	1.88	0.75	0.40	150	*	—	15.0	—	0.0045	12000	—	4.0	5.5	0.2
19002	Mi	1.82	1.56	0.75	0.15	250	7	—	6.3	—	0.0114	2900	—	1.4	1.2	1.1	
Dual Triodes (Values for each unit)	6F8G	G	4.47	3.91	1.56	0.60	250	8	—	9.0	—	0.0077	2600	—	3.8	3.2	1.0
	16N7GT/G	B	3.31	2.75	1.31	0.80	300	6	—	7.0	—	0.0110	3200	—	—	—	—
	16SC7	M	2.63	2.06	1.31	0.30	250	2	—	2.0	—	0.0530	1325	—	2.0	2.2	3.0
	7F8	L	2.03	1.50	1.18	0.30	250	2.5	—	10.0	—	0.0100	5000	—	1.2	2.8	1.8
16J6	Mi	2.13	1.88	0.75	0.45	100	**	—	8.5	—	0.0071	5300	—	1.6	2.2	0.4	
Dual Diodes	—	G	—	—	—	—	Max. Rms.	—	—	Max.	—	—	—	Plate to Plate Cap.			
	6H6GT/G	B	3.31	2.75	1.31	0.30	150	—	—	8.0	—	—	—	—	0.1	—	—
	6H6	M	1.75	1.18	1.31	0.30	150	—	—	8.0	—	—	—	0.1	—	—	
	7A6	L	2.78	2.25	1.18	0.15	150	—	—	10.0	—	—	—	0.05	—	—	
6AL5	Mi	1.81	1.56	0.75	0.30	150	—	—	8.0	—	—	—	0.026	—	—	—	
Power Amplifier	6V6G	G	3.31	2.75	1.31	0.45	315	13	225	34.0	2.2	0.077	3750	Output Waits	—	—	—
	6V6GT	B	3.31	2.75	1.31	0.45	315	13	225	34.0	2.2	0.077	3750	5.5	0.7	9.5	7.5
	6V6	M	3.25	2.68	1.31	0.45	315	13	225	34.0	2.2	0.077	3750	5.5	0.3	10.0	11.0
	7C6	L	3.37	2.84	1.25	0.45	315	13	225	34.0	2.2	0.077	3750	5.5	0.7	9.5	7.5
	6AK6	Mi	2.12	1.87	0.75	0.15	180	9	180	15.0	2.5	0.2	2300	1.1	0.12	3.6	4.2

† Double Cathode Leads.  
\* 100 Ohm Cathode Bias Resistor.  
\*\* 50 Ohm Cathode Bias Resistor.  
‡ Common Cathode.  
§ Units in parallel.

G Glass  
B Bantam  
M Metal

L Loctal  
Mi Miniature

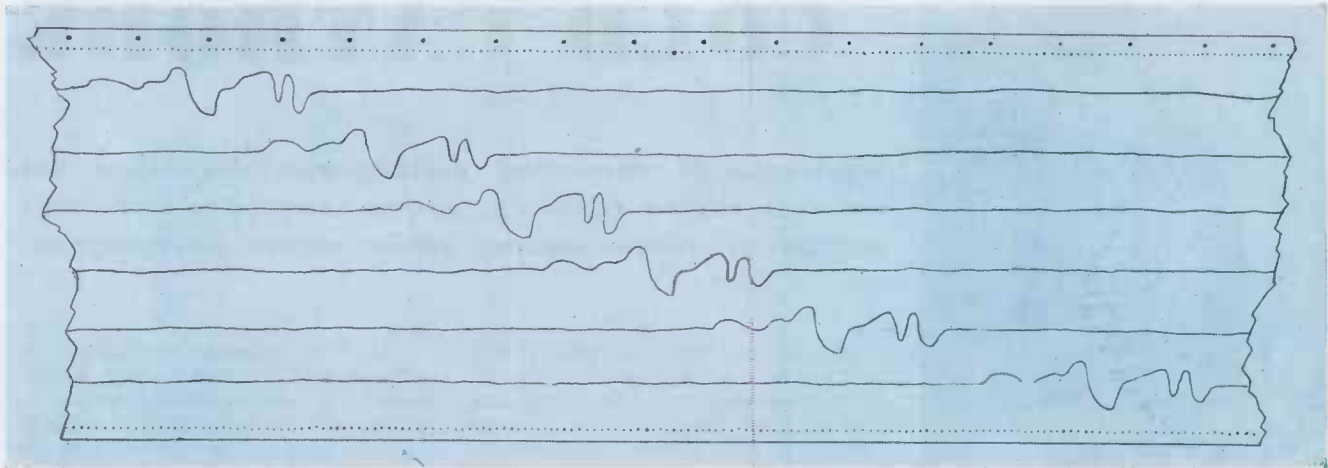

Radio signals of the sound of guns, picked up at several remote locations, are transmitted to the central station where records are made on electro-sensitive paper. From such records the location of enemy guns can be determined by triangulation

# GUN SOUND RANGING

*Radio equipment and methods used by the Army for quickly locating the positions of enemy artillery emplacements*

● The deadly accuracy and power of American artillery has proved overwhelming to the enemy. Dazed Nazi soldiers have been picked up by advancing Yanks who have reported their incoherent mutterings: "Your artillery. It is too much. No man can stand up to it."

As the war enters its final lap on the Western Front and speeds up in the East, the increasing effectiveness of American field artillery begins to mean the difference between life and death to American infantrymen moving up against the enemy. It is the artillery that reduces fortifications, blankets areas with massed firepower to keep the enemy immobil-

ized, and by counter-battery fire nullifies the enemy's own artillery.

To aid in this last-mentioned mission, the Signal Corps of the Army Service Forces has steadily improved the sound ranging equipment used by the artillery to "spot" enemy guns. Sound ranging consists of a means of picking up the sound of a muzzle blast of an enemy gun and timing its arrival at some central location. Then, through a process of triangulation, it is a simple matter to pinpoint its location and to destroy it by gun fire.

The equipment used in sound ranging includes microphones, a timer, and a recorder. The micro-

phones, strung along the front in any geometric figuration, detect the signal. It is then amplified, and transmitted over wire to a central location where each signal is timed and recorded. The record indicates the difference in times of arrival of the same sound from the several microphones and in this way the location of the enemy gun can be determined.

Wire has been the mainstay for relaying the signal picked up by the microphones. About ten miles of wire is ordinarily used for this purpose. Early last year, however, it was found that the ravages of enemy shell fire, plus the dislocation caused by friendly vehicular traffic—tanks, trucks, etc.—introduced interruptions that defeated the effectiveness of this method of transmission. Mountainous terrain, especially on the Italian peninsula, also was a problem.

It was found that radio waves could be used to transmit the sounds picked up at the microphones back to the recording station. But before radio equipment could be utilized, it was necessary to find a means of transmitting signals between 5 and 25 cps, much below the audio frequency range of standard Signal Corps radio sets. Although the design of such sets was possible, the procurement and distribution of such equipment would take time. The need was immediate, however. The solution finally arrived at was the introduction of a modulator unit to be used with regular field artillery radio sets. (Continued on page 230)

Essential parts of the Signal Corps sound recording equipment showing the plate supply and timer, the sound recorder and one of the microphones

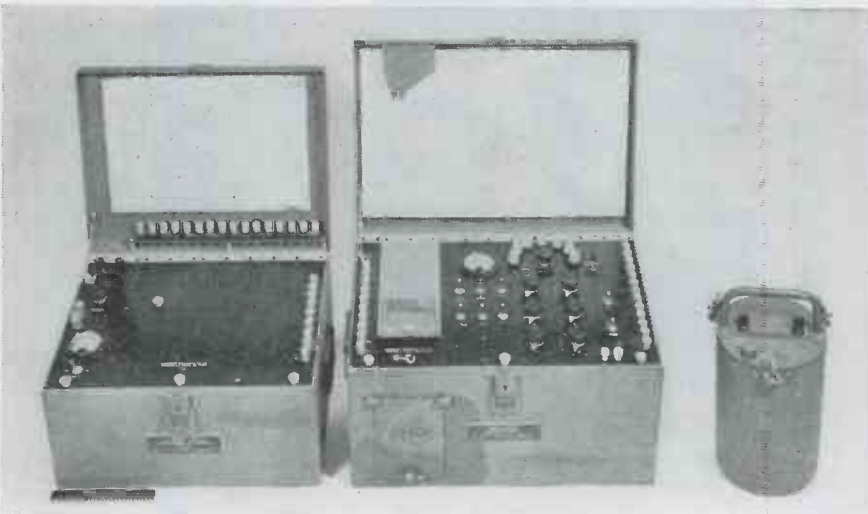

# COLD CATHODE

**Westinghouse recording oscillograph developed for aircraft engine research, power companies and other studies of surges taking place within microseconds**

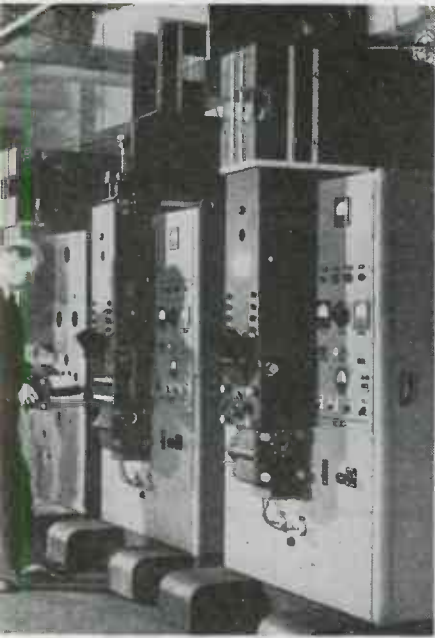

Fig. 1—Four of the new 50 KV cold cathode oscillograph units being tested

● Laboratories of all types, whether devoted to research, testing or servicing have found that a cathode ray oscillograph is an indispensable research instrument. The inexpensive laboratory type of equipment has become so convenient to use in the simple routine investigations as to promote the belief that they are universally applicable to all problems.

Occasionally, a problem is found wherein really high speed phenomena are to be analyzed; non-recurring effects that are all over in a matter of milliseconds. Here the eye is inadequate even to see much of the oscillogram let alone memorize its appearance. A cathode ray oscillograph operating at high voltages is the only means available for the complete analysis of phenomena that occurs at random intervals and is completed in the order of one microsecond or somewhat more.

In industrial oscillography, emphasis is placed on reliability and accuracy rather than low costs that accompany simplicity. Oscillographs designed for this service are characterized by high anode voltages, possibly 50 kv, and some provision for the direct exposure of photosensitive films (which are also electron-impact sensitive) to the electron ray. In order to insert or withdraw these films it has been necessary to develop a new technique in tube construction and to provide permanently-connected vacuum pumps for re-evacuating after each loading. From seven to ten minutes are required to evacuate the tube after reloading.

The usual tests to which this oscillograph is applied, are related to transmission line characteristics, transformer design, circuit breaker operation, lightning arresters, corona losses, engine ignition studies, etc. In this field, transients of the order of a microsecond duration are usual, while in extreme cases, the successful recording photographically of transients of one milli-microsecond have been reported. Transverse movements of the spot at speeds up to 500 miles per sec. on the film can be handled.

The appearance of a high speed oscillograph constructed on these principles is considerably different from that of the common portable laboratory models. The envelope is generally of metal, with special parts that permit the placement of the recording film in the direct path of the rays.

The Westinghouse electronic oscillograph illustrated in Fig. 1 represents a commercially available instrument for recording on photographic film or for observation on a fluorescent screen, of single electrical transients of very short duration. The oscillograms usually are recorded on stationary film (frame size  $3\frac{1}{2} \times 3\frac{1}{2}$  in.), with the electron beam being deflected in two directions, namely along the time axis by a timing voltage, and perpendicular to it, by a voltage derived from the phenomenon under observation. Instead of the timing voltage another quantity related to the measured voltage can be introduced; in this manner voltage-current characteristics or the relation between two voltages can be recorded.

One of the problems encountered in tests for which this oscillograph is adapted is that of film fogging

Fig. 2—(Left) Central compartment contains molecular pump just below center with the Megavac backing pump at lower right. Timing circuit appears upper right. Left compartment contains remainder of control circuits. (Right) In normal use electron ray is developed continuously but is absorbed by the trap device shown until the surge to be measured appears

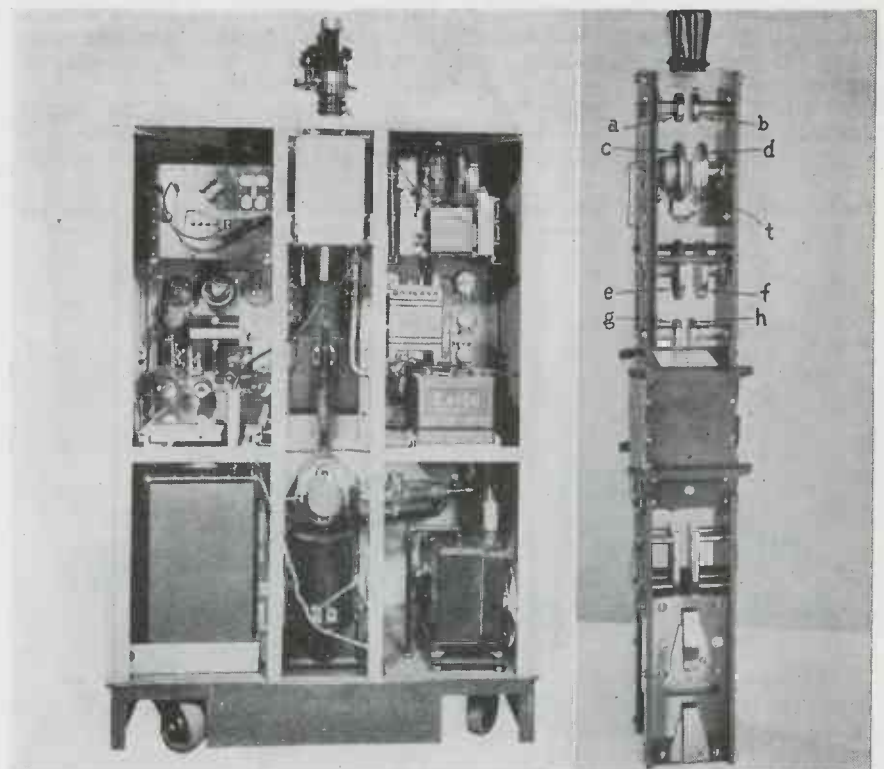

# OSCILLOGRAPH

during long waiting intervals before a lightning surge or a transmission line switching transient "happens" to occur. When such a surge does occur it only happens once, and the whole thing is over in a few millionths of a second. For this reason the tube is provided with a "Norinder beam trap" which permits the refocusing and adjustment of the ray without premature exposure of the film.

The tube, in many tests, is left in an operating condition over extended periods, waiting for the transient to appear (such as in the study of lightning surges on transmission lines). Were the ray to be directed toward (or off) the edge of the screen during such an interval, the stray and reflected electrons would soon fog the film. Even when the ray hits the side of the tube at an angle, a great many electrons may be reflected. Un-

usual precautions are provided, therefore, toward eliminating these effects.

In the "beam trap" development of Norinder, a small target (t) is mounted directly in the path of the cathode ray after it leaves the anode orifice (see Fig. 2B). Two deflection plates (a) and (b) are mounted between the anode and this target, which, when supplied with a suitable dc potential, will deflect the ray so that it misses this target entirely. Thereupon it enters the field of either of two additional pairs of plates, which are cross connected with the first pair of plates (plates c and e are connected to b, and plates d and f are connected to a) so that no matter what the extent or direction of the original deflection it is completely neutralized while the ray traverses the second pair. Thereupon it enters the deflection fields, from the

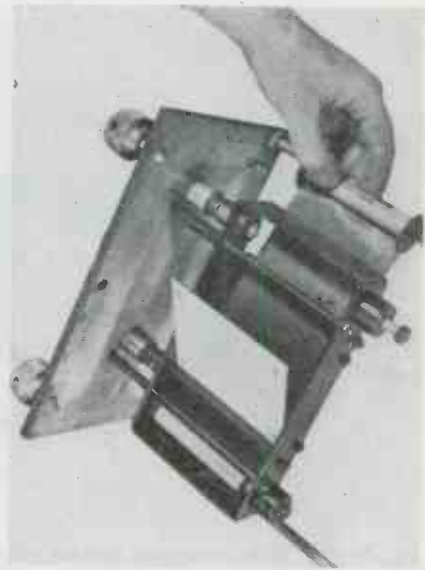
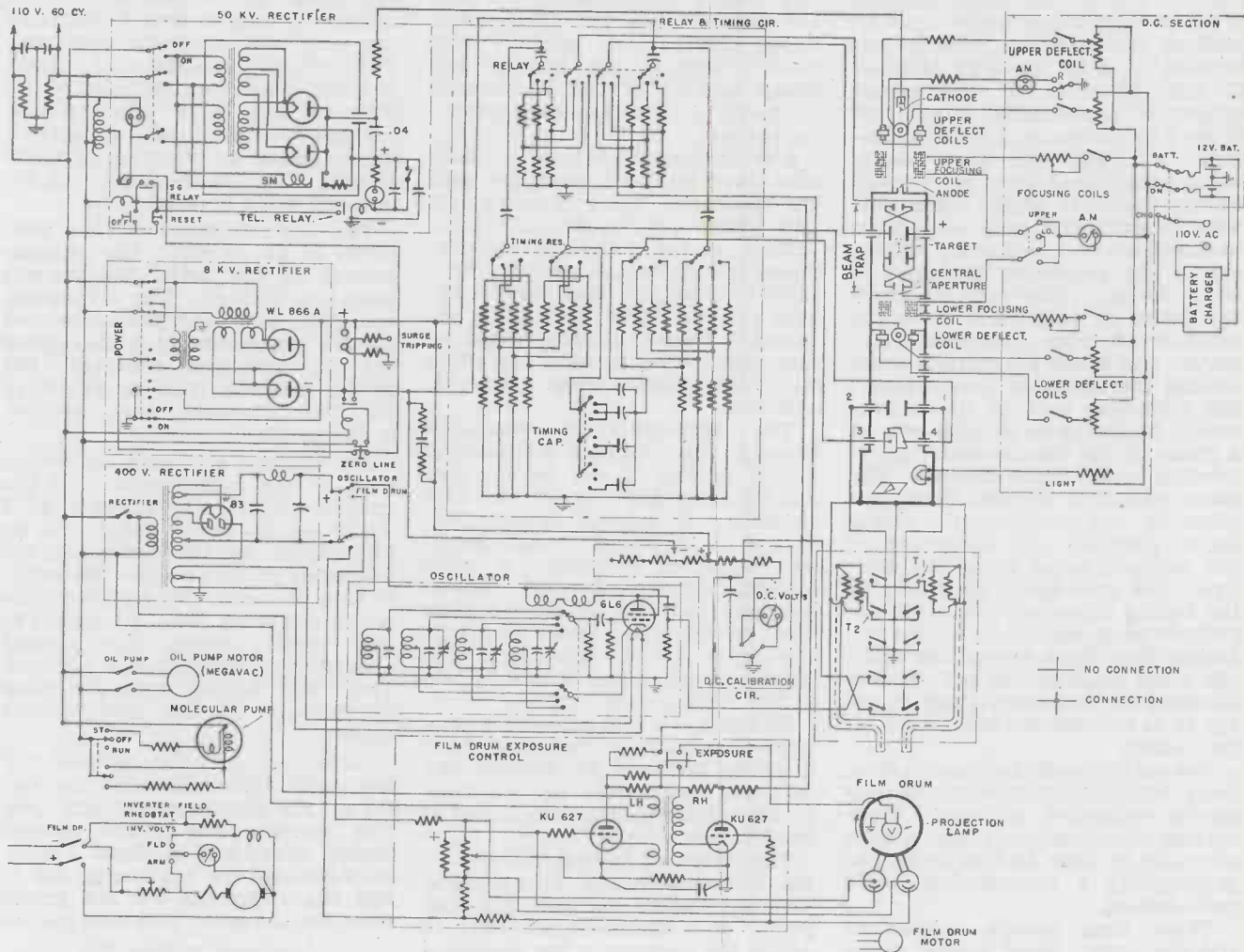

Fig. 4—Roll film holder and viewing screen is inserted from front, located directly below the viewing screen, Fig. 1

normal deflection plate system, in the original axial direction. Whenever the potential is removed from the combination of deflection plates

Fig. 3—Circuit diagram showing essential parts of the oscillograph tube and its associated control arrangements



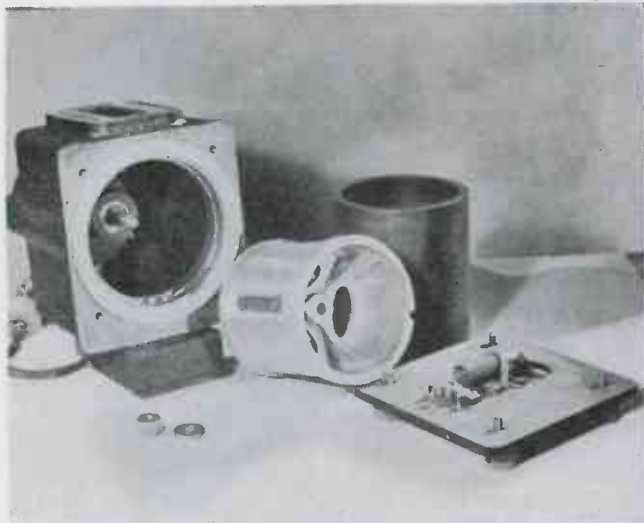

Fig. 5—Film drum attachment showing housing and the dark shield which permits the loaded drum to be handled in daylight, at the rear, the drum and cover in front. Drum is rotated by synchronous motor integral with housing



Fig. 6—Molecular pump, backed by Megavac pump, exhausts oscillograph chamber in from 7 to 10 minutes to a lower pressure than necessary. Vacuum pressure is then adjusted by valving in a small amount of air

comprising the beam trap, the ray again strikes the target and is absorbed.

The simplified schematic diagram of the oscillograph timing and beam release circuit is shown on Fig. 3. The double surge tripping is set so that it just holds the 4 kv positive and negative polarity impressed on it by the 8 kv rectifier. If the potential of the center sphere is temporarily thrown off ground by means of a tripping impulse, one gap will break down, which will immediately be followed by the flashover of the other gap. This permits the relay capacitors to discharge and to develop voltage across the resistance branches of relay circuit. The voltage across the latter is impressed upon the oscillograph relay (Norinder relay) plates; this bends the cathode beam around the target so that it enters the recording part of the instrument. At the same instant one, or a group of the timing capacitors as selected begins being charged. The rising capacitor voltage, being applied to the oscillograph timing plates produces the movement of the cathode beam along the time axis. The subsequent discharge of the timing capacitors will make the cathode beam retrace its movement. During this "back sweep" the cathode beam must be blocked. This is achieved by the relay voltage receding so as to force the beam back on the target.

The oscillograph equipment contains four resistor groups and four timing capacitor settings. Their various combinations afford a wide selection of time sweeps from approximately 1 microsecond to 20 milliseconds.

These time sweeps appear as straight lines. Their correct func-

tioning can best be checked visually by connecting in the high frequency timing oscillator, by closing the "oscillator" switch. The available frequencies of 50,000, 250,000, 1,000,000 and 5,000,000 cycles provide timing marks of 20, 4, 1 and 1/5 microseconds per cycle. The timing marks are spaced more closely towards the end of the sweep because of the exponential character of the condenser charging process.

A dc calibrating voltage is available when needed to compare with the potential being investigated. The source for the dc calibrating voltage is the 8 kv rectifier reduced to the voltage recorded by a 2,000 volt meter. Four fixed voltages of either polarity can be obtained. These voltages record as lines parallel to the time axis when the "Zero Line" push button is operated.

The oscillograph is evacuated through two pumping connections shown in Fig. 2, one at the discharge tube, and one at the film chamber. A molecular pump (Fig. 6) and an oil sealed vacuum pump are connected in series. A valve located between the two pumps seals off the high vacuum section from the oil pump when the oscillograph is not in operation. The megavac (oil) pump also exhausts a film drying tank.

All fresh roll film contains a considerable amount of moisture which must be removed by keeping the rolls for some time in the film-drying tank, which carries a load of dehydrating powder.

The pumping system will evacuate the oscillograph to such low pressure that no discharge can take place. It is therefore necessary to adjust the pressure in the discharge

tube so that a proper cathode beam is formed. This is done by means of the air leak valve. This may seem odd to those accustomed to using the regular sealed-off oscillograph tubes, which are highly evacuated. In the tube here, a cold cathode is used so that a discharge can only take place by ionization. The cathode consists of a highly polished aluminum cylinder 1/4 in. diameter and 3/4 in. long. A discharge crater eventually appears on this cathode, so provision is made so that it can be removed and repolished when necessary.

The high voltage rectifier produces 50 kv dc when the primary voltage is 100 volts, the normal operating voltage. The HV switch energizes both the filaments and the HV transformers; it also opens the oil immersed contactor SM whose function it is to discharge the filter capacitor when rectifier is de-energized.

The cathode ray beam current is read on the milliammeter. If the current should rise above 2 to 3 milliamps the power supply will be interrupted by the action of the telephone relay and the SG relay. If this happens, the rectifier voltmeter will show zero. By means of the "reset" button, the normal operating connections are restored. The "OFF" button serves for quick interruption of the high voltage circuit.

Adjustments of the cathode ray are made while observing the latter on the fluorescent screen. For this purpose the beam current should be reduced to about .1 milliamp because the protracted use of full beam strength on the screen discolors the latter and fatigues the

(Continued on page 221)

# THERMAL STABILITY in RECEIVER OSCILLATORS—II

By RALPH R. BATCHER  
Consulting Editor, Electronic Industries

*A survey of the fundamental causes for oscillator drift by temperature effects, leading to the selection of a suitable compensation device*

● In part I, certain conditions were analyzed where the physical assembly of a tuning capacitor affected the frequency drift of the circuit. Another cause for drift is often encountered that may result in even larger changes—that of the dial mechanism. Every set, at least when it is of console dimensions, has its own tuning control design, so it is impossible to bring out universally applicable suggestions here.

In some cases it is a three-way problem: the capacitor rotor, the frequency indicating pointer or dial, and the driving knob each being on different shafts linked together by gears, cords and pulleys or some friction device. These linking mechanisms have expansion stresses with temperature changes which have to be relieved, and it may be found that any one of these three items may change.

Since the control knob rotation usually is geared down to turn the capacitor shaft it is generally the last to shift. On the other hand, the capacitor shaft is free running and moves first. The movement may be either rotational or radial. The latter, to a certain extent, produces warping of the whole condenser structure.

Very few tuning capacitors, designed in the price range necessary for use in receivers, will stand much of this pressure on the shaft, without introducing large and erratic frequency shifts. Although it sometimes happens that these shifts accidentally compensate for other variations, unless the structure is rigid enough to withstand such pressures, the use of friction or pressure discs or cords should be avoided. The temperature/frequency drift rate so introduced is unpredictable and is not repeatable even in a single set.

In one case it was found that opposite humidity and temperature drift effects were produced by a simple change of the location of the tension spring in the string of a cord and pulley drive! The shrinking or expansion of the cord

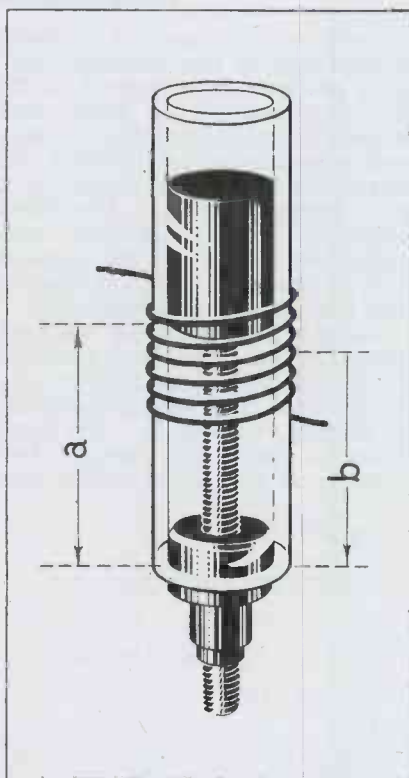

Fig. 1—A typical permeability tuned coil. Different temperature effects can be found if the expansion length of the screw is more or less than the distance along the winding form, to the winding center, although the same total inductance may result in either case.

due to either factor could thus be made to rotate the condenser shaft either clockwise or counter-clockwise as desired. A study of any proposed drive design for such possibilities should always precede its tooling up to avoid inviting large and uncompensatable drift troubles.

## Inductance drift

So far, attention has been called to certain outstanding sources of instability in the tuning capacitor in the circuit. Notwithstanding best intentions, however, a certain amount of drift is inevitable, so that some compensation is always necessary if a low order of drift is

to be attained. Before the proper kind and amount of stabilization can be determined it is necessary carefully to analyze the records of the average drift actually found and to discover the "probable" cause. The qualifying word "probable" is used because the thermal drift in some elements follows unusual laws and produces unpredictable curves.

A single layer inductance, wound in a grooved form, may have a variation in length that is controlled by the expansion of the form material, while its diameter may depend on the expansion rate of copper. If the expansion rates of the diameter and length were equal, one would expect that the inductance would change in direct proportion to the change in any one dimension with temperature. Also if the length could be made to increase twice as fast as the diameter, the temperature effect on the inductance would be zero.

However, it is necessary that the wire be wound with enough tension so that it remains tight at all temperatures to be encountered. In this case the temperature coefficient depends entirely on the expansion rate of the form material, since diameter and length are both affected at the same rate, and little can be done practically to utilize this method of securing a low coefficient.

In circuits using multilayer coils (as for example the diamond weave or self-sustained type) other effects are to be noted. Here the diameter of the first few layers may be influenced by the expansion of the form, but the rest of the layers depend on the expansion rate of copper. The length of the winding may follow one of several variation laws, since the wires have a tendency to spread out or contract sideways to equalize strains in any direction, like an accordion.

If impregnated with wax, the length depends upon the expansion of the wax, while the diameter depends largely on the expansion of

copper. It is even possible to use a wax that gives a negative coefficient of inductance drift with temperature, if it expands enough! Proper impregnation is the most important factor in coil design as far as low drift rate is concerned, but the correct wax for one coil shape ratio may be the wrong type for another.

The thoroughness of waxing is a deciding factor and the expansion rate changes enormously if a heavy dip in melted wax is replaced by a light dip, or if the impregnation is accomplished by evaporation with the use of waxes dissolved in a solvent. In passing, attention is also directed to the ever-present shift in the distributed capacitance of a coil, as the impregnating compound is changed. Waxes have large

Fig. 2—Basic tuning circuit of an oscillator or amplifier. C represents the adjustable portion of circuit capacitance; the elements with triangle prefixes are increments (either positive or negative) produced by temperature, etc.

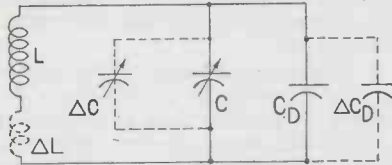

temperature coefficients in their dielectric constant characteristics, so that even if all other effects are accounted for, this factor may complicate the correction curve. Luckily this variation is of the type that is accurately handled by negative coefficient ceramic trimmers or bimetallic capacitors of other types.

It is possible to measure the drift of the distributed capacitance coefficient quite easily by considering the multilayer impregnated coil as a capacitor and connecting it in shunt with another coil with a much lower inductance value, and making measurements at a frequency a couple of decades higher up the range.

All plastics have a large coefficient of expansion, compared with metals. At times this can be utilized in producing a negative inductance variation coefficient. For example, a layer wound rf coil on a bakelite or polystyrene tube normally will be considered to have a positive coefficient, so that the inductance goes up with temperature. In the usual mounting arrangement with permeability tuning, the core slug will move relative to the coil, by an amount depending on the relative expansion rates of the coil form and the screw mounting of the slug. If this expansion pushes the two together at increased temperatures, a positive coefficient will result. If they move apart, a negative coefficient is found. In Fig. 1, the tuning slug moves in accord-

ance with the expansion rate of brass, but the winding moves at a greater rate, that of polystyrene.

If desired, the slug can be moved even greater distances by the movement of a thermostatic bimetallic strip. Study of the curves in Fig. 3 will show the compensating trends of a variable inductance compared with a capacitor type and indicate which is preferable for a given circuit. It has been shown\* that a typical coil wound on a polystyrene tube may have either a positive or a negative coefficient depending on whether the tube thickness is greater or less than 1/8 in.

### Compensation

There are two general methods of approach to the frequency stability problem: improvement in the operating stability of each component, or the application of corrective means for neutralizing the overall shift that is found in a well-designed setup. Corrective measures will be effective only when they follow up the original shift at the same rate, considering both temperature and frequency.

Consider a simple basic resonant circuit, Fig. 2. Here  $C_D$  is assumed to include all capacitance in the circuit when the tuning capacitor is entirely unmeshed. As mentioned in Part I the resonant frequencies at two temperatures are:

$$f = k/\sqrt{L(C+C_D)} \quad (1)$$

$$f' = k/\sqrt{(L+\Delta L)(C+\Delta C+C_D+\Delta C_D)} \quad (2)$$

$$(f/f')^2 = (1+\Delta L/L)[1+(\Delta C+\Delta C_D)/(C+C_D)] \quad (3)$$

$$= (1+A)(1+B+D) \quad (4)$$

where

$$A = \Delta L/L; \quad B = \Delta C/(C+C_D); \quad \text{and } D = \Delta C_D/(C+C_D) \quad (5)$$

$$(f/f_1)^2 - 1 = R^2 - 1 = A + B + D \quad (6)$$

In the above the  $\Delta$  factors represent the increments in the values of the respective factors caused by some operating change. They may be either positive or negative. In obtaining eq. (6) from (4) the second order effects AB and AD can be ignored.

To utilize this relation the value of R must be obtained at several frequencies by direct measurement.

In this analysis the value of C is assumed to be the incremental capacitance of the variable capacitor since its "zero" capacitance has been lumped in  $C_D$ . Then  $\Delta C$  represents the shift due to normal rotational movements of the rotor.

The relation in (6) shows that shifts of equal per cent magnitude in any one of the three components

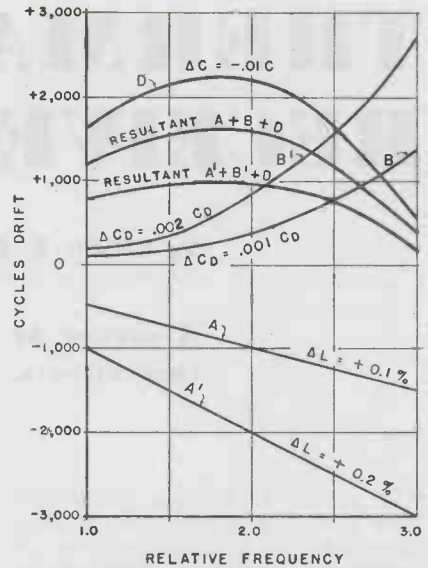

Fig. 3—Typical frequency drift trends from various circuit components

will produce equal changes in frequency. Over the complete frequency range, a straight line law does not exist, however, because of the change in C and  $\Delta C$  as the tuning is changed, a square law difference between f and C being found. It will be found, however, that it is impossible to accurately apply eq. (6) to interpret experimental data so as to determine the importance of A, B or D, even by making complete temperature-frequency runs at numerous points within the operating range.

There are several analytic expedients that will prove of value if another assumption is made: that the value of L and  $\Delta L$  (or A) does not change with frequency, at least within a narrow frequency range of say 2:1. It is possible to eliminate the effect of the variable capacitor (that is item B) by the simple process of turning it so that the plates are entirely unmeshed and making a temperature run in this condition. In this case (6) reduces to  $R^2 - 1 = A + D$ .

It can be assumed, following the above definition of D, that its value does not change with frequency, although its effect is dependent on a "cube law" relation.

This is an important relation, since means for obtaining temperature compensation by the use of ceramic capacitors with large temperature coefficients (either negative or positive, as the case requires) provides a correction that follows this rule.

This cube rule is an approximation but is essentially correct when  $C' \gg \Delta C$  and  $C' < C$ . Here  $\Delta C$  is a capacitance increment that may occur at any point in the tuning range, and  $C'$  is the capacitance at the highest frequency point ( $f'$ ) of the range, and C is some other

\*"Polystyrene Applied to Radio Apparatus," RCA Review, Oct., 1939, page 203.



capacitance at a lower frequency (f) in the range. The rule states that the relative frequency increment caused by  $\Delta C$  is very nearly proportional to  $(f'/f)^3$ . For example, if the useful tuning range is 2.8:1, a capacitance shift of 1 mmf will cause  $2.8^3 = 21.95$  times as much frequency shift at the high frequency end of the range as at the other end. Using the common relations between f and C, it can be shown that:

$$\Delta f / \Delta f' = \frac{k/\sqrt{C} - k/\sqrt{C + \Delta C}}{k/\sqrt{n^2 C} - k/\sqrt{n^2 C + \Delta C}} \quad (7)$$

where  $n = f'/f$  (8)

$$\Delta f / \Delta f' = \frac{n(\sqrt{C + \Delta C} - \sqrt{C})(\sqrt{n^2 C + \Delta C})}{(\sqrt{n^2 C + \Delta C} - n\sqrt{C})(\sqrt{C + \Delta C})} \quad (9)$$

Assuming that  $C \gg \Delta C$ , which is correct in practical cases, as when  $\Delta C$  is the capacitance variation due to thermal expansion effects only, then

$$\sqrt{C} = \sqrt{C} + \frac{\Delta C}{2\sqrt{C}} + \frac{\Delta C^2}{4C} \quad (10)$$

and

$$\sqrt{n^2 C + \Delta C} = n\sqrt{C} + \frac{\Delta C}{2n\sqrt{C}} + \frac{\Delta C^2}{4n^2 C} \quad (11)$$

Substituting (10) and (11) in (9) and omitting terms containing  $(\Delta C)^2$ .

$$\Delta f / \Delta f' = n \left( \frac{2n^2 C + \Delta C}{2C + \Delta C} \right) \quad (12)$$

$$= \frac{2n^3 C + n\Delta C}{2C + \Delta C} \quad (13)$$

This relation (13) becomes an important factor in the application of temperature compensation of the capacitive type. Since the important term is the first term in the numerator, it means that at two frequencies anywhere in the operating range (f) and (f'), the respective frequency - increments ( $\Delta f$ ) and ( $\Delta f'$ ) have values inversely proportional to the cube of the ratio between f' and f. Thus, if a 10 mmf compensating capacitor having a characteristic giving 750 parts per million change per degree follows a 20 degree temperature shift (0.15 mmf absolute change) and causes a frequency change of 5,000 cycles at one mega-

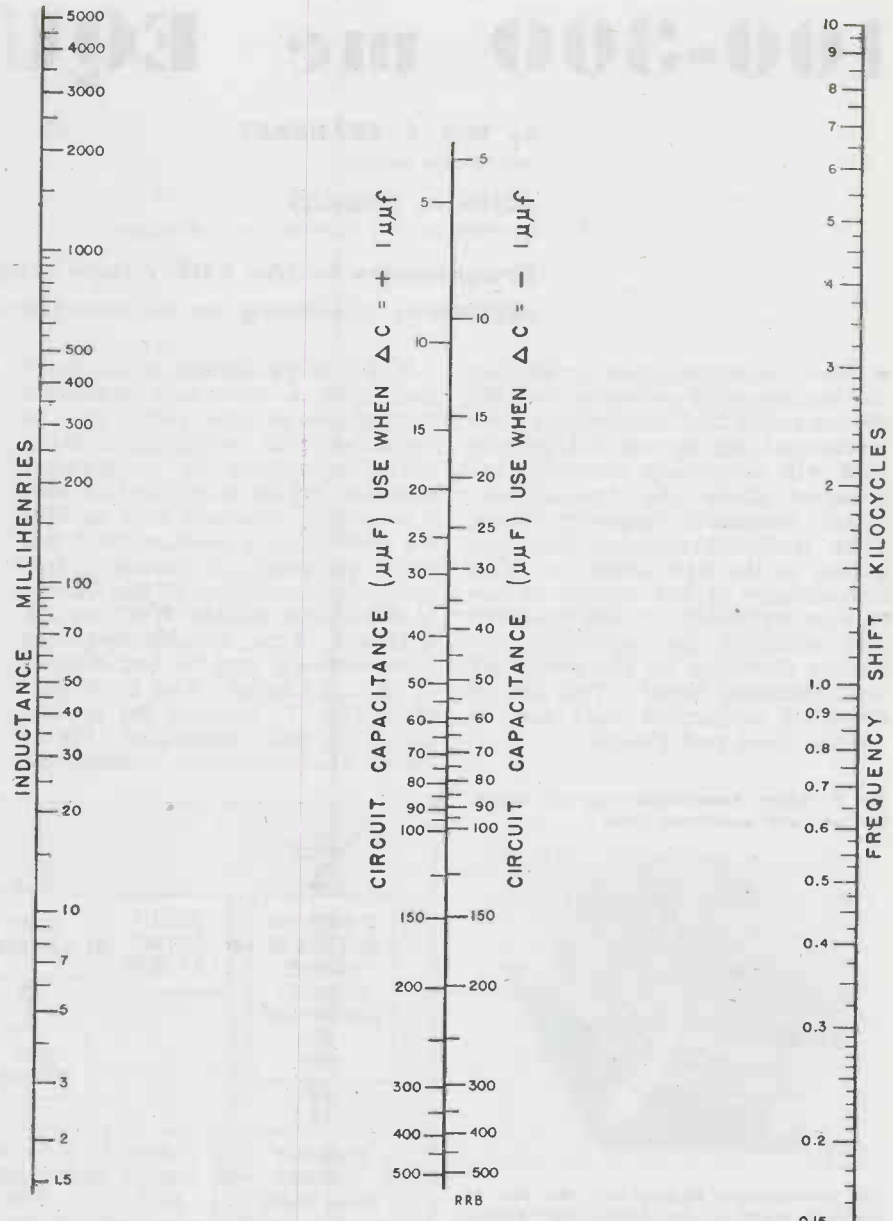

Fig. 4—Effect of 1  $\mu\text{mf}$  incremental capacitance on frequency shift under various parameters

cycle, it would cause a change of 40,000 cycles at the two megacycle point on the dial if the only difference between the settings is the position of the tuning capacitor rotor.

A chart, Fig. 4, may be found of interest in determining the frequency shift caused by a small capacitance increment under various

circuit conditions. Knowing the actual frequency shift at any point in the range, it is possible to determine the required corrective capacitance to compensate for this shift. Application of this cube rule will show the resulting change at other frequencies in the range.

It is desirable that a plot be made of the data obtained in any frequency run, as the resultant curve in Fig. 3. From these data, it is often possible to estimate the probable cause for any shift discovered and to estimate the best procedure—whether inductive compensation or capacitive compensation should be used. To improve the resultant curve A + B' + D in Fig. 3 still more, it would be necessary to increase  $\Delta L/L$  to about 0.25 per cent (that is—actually to make the coil "worse") and to add more

(Continued on page 224)

Relative frequency	C + C <sub>D</sub>	C when (C <sub>D</sub> = 36)	$\frac{\Delta C}{C} = .01$ (assumed)	Relative effectiveness of C. (cube rule)	$\Delta f$ (relative)
3	40	4	$\Delta C = .04$	27.	1.08
2.5	57.6	21.6	.216	15.62	3.37
2.0	90.0	54	.54	8.00	4.32
1.5	160.	124	1.24	3.37	4.18
1.0	360.	324	3.24	1.00	3.24

# 100-300 mc EQUIPMENT

By **WM. F. FRANKART**  
Radio Design Engineer

**JOHN A. RHOADS**  
Chief Engineer, Air Associates, Inc., Los Angeles

**Frequencies in the VHF range may be measured directly with sufficient accuracy to be acceptable by government agencies**

● Many manufacturers producing vhf equipment to operate in the 100-300 mc range find themselves in the position of not having instruments that will accurately measure frequencies above the typical secondary standards frequency range. They therefore compare the frequency of the item under test with a harmonic of the crystal or oscillator frequency of that standard and multiply the resulting frequency deviation by the frequency multiplication factor. This article describes equipment that can be built in most model shops.

With this equipment, in conjunction with a secondary standard, frequencies in this range can be measured with sufficient accuracy to be acceptable by government agencies. Its use in connection with a secondary standard such as Millen 90505 and a receiver that will allow reception of standard frequency transmissions of the Bureau of Standards station WWV on 2.5, 5, 10 and 15 mc, reliable frequency measurements may be had directly at this vhf range. The block diagram (Fig. 1) conveys the general setup of this apparatus. Fig. 2 shows the frequency multiplying,

mixing and detection system as contained within the dotted lines of Fig. 1.

In this gear, several relatively new items are used such as the Sylva EF-50 tube and "butterfly" type tank circuits. This tube is the American version of a standard European type being produced in this country for lend-lease purposes. A special 9-contact octal socket as manufactured by Cinch is necessary.

This tube is well adapted for hf amplifiers, inasmuch as it has a high mutual conductance together with high input impedance. In ad-

Fig. 3 (Below) Experimental type of "Butterfly" unit with logarithmic plates



Fig. 2—Equipment dealing with this part of system is shown in views below. The "Butterfly" in the lower compartment is adjacent to plaques carrying V5 and V6 tubes. The upper "butterfly" is associated with output probe, and carries V4 double triode. Coaxial lines connect input of this tube to previous stage

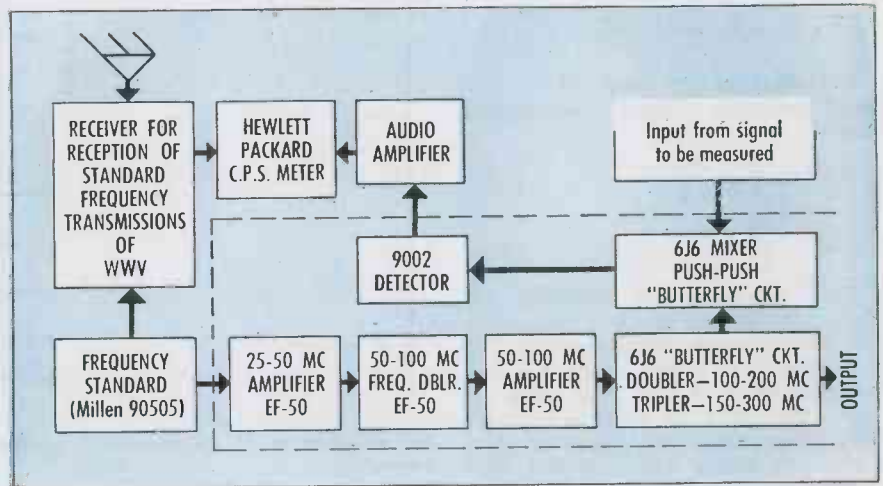
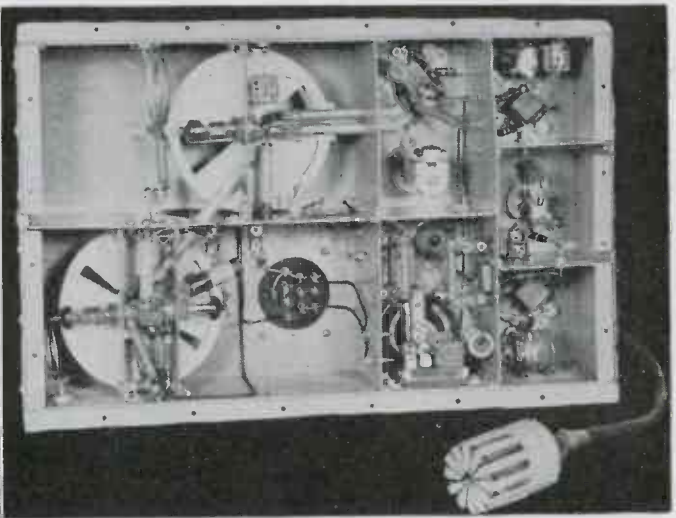
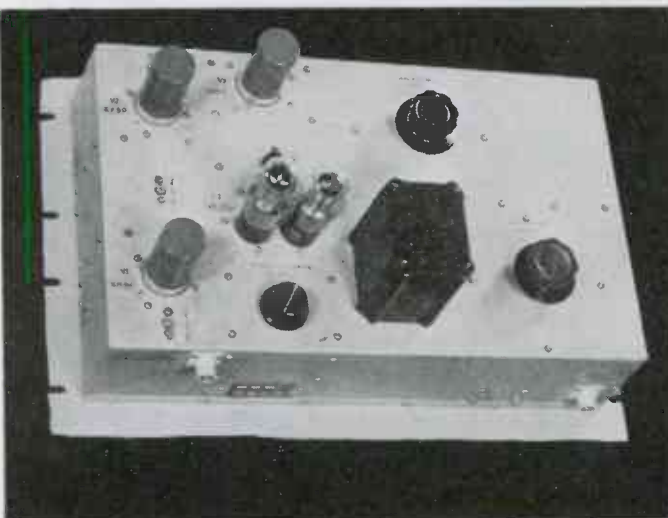

Fig. 1—Frequency multiplying, mixing and detection system contained within dotted lines in block diagram above



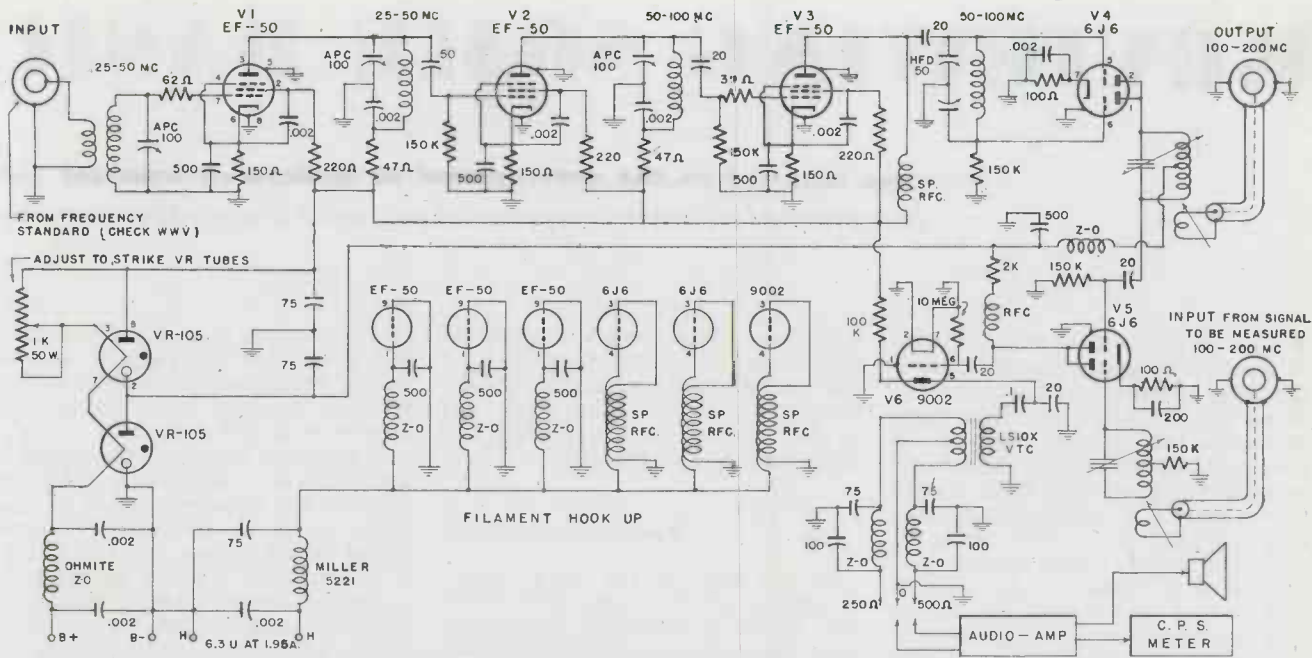

Fig. 4—Wiring diagram of the 100-300 mc measuring equipment. The two "butterfly" tuners are shown coupled to the probes at right

dition, it is well shielded. Using this tube, stage gains of as high as thirty have been measured at 75 mc. In this setup, the two pins provided for connection to the shield have a separate bus to ground. The lock-in guide pin and one side of the filament are tied

together and the bus connected to ground. Another excellent tube for this application is the Sylvania type 1204 pentode. The input impedance of this tube is much higher than the EF-50; however, the mutual conductance is considerably lower. This lower Gm is compensated for by the higher input impedance; consequently, the stage gain is comparable.

the frequency is first doubled because tube V4, the 6J6 operating either as a push-push doubler or push-pull tripler, requires considerable drive.

In the construction of this equipment all parts, including the chassis, in the rf circuits are either copper or silver plated. Centralab type 830 silver mica by-pass capacitors and Erie feed-thru ceramic capacitors are used as they lend themselves to good vhf layout. All coupling capacitors are silver mica. The schematic diagram, Fig. 4, shows the part values used. The extent to which proper circuit isolation was carried out is also conveyed. The unit is built on a 10 x 17 x 4 chassis.

The mixer stage, a 6J6, (V5) may be used to combine two external signals; one introduced through the coaxial connector designated out-

(Continued on page 194)

### "Butterfly" construction

The "butterfly" circuit affords a relatively high Q constant L-C ratio tank of small physical size that lends itself well to mechanical layout. The "butterfly" is constructed from SAE 1020 C.R.S. 16 ga. After fabrication, all parts are copperized, then silver plated. Since the output of the Millen standard is feeble in the 25-50 mc range, an amplifier is used before



Fig. 5—(Above) View of the Faraday shielded probe, and below, constructional details for the fabrication of the probe and shield, and the plates of the "butterfly" tuner. Alternate shapes of rotor plates having logarithmic and sector contours are shown

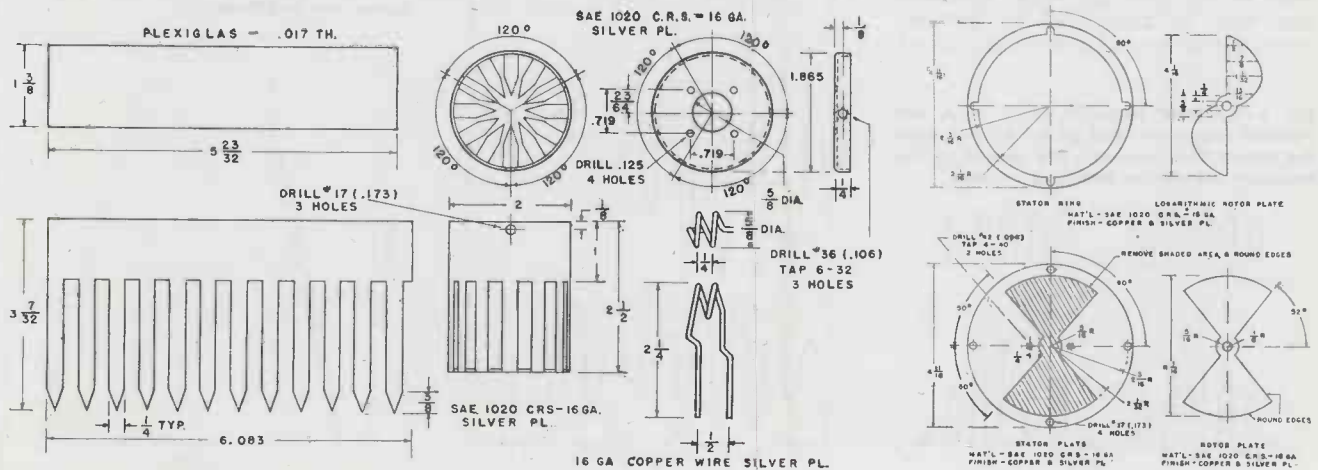

# REVIEWING SOME BASIC

## Steps that led to the development of modern systems for superimposing voice frequencies on radio frequency carriers

• One of the outstanding features of electrical communication during the 20th century has been the use of carrier transmission. The term first came into general use with the development of carrier telephone systems for open-wire lines nearly thirty years ago, and the process of superimposing voice frequencies on their carrier was called modulation. Ac carriers, however, were used long before the advent of open-wire carrier systems, and modulation, although it was not always recognized as such, is as old as electrical communication.

It was probably during the early attempts to develop radio telephony that the concept of modulation became clarified, since that was the first time that a modulated carrier was obviously used. In a broader sense, however, all electrical communication employs a modulated carrier, whether dc telegraphy and telephony or radio telegraphy. With the early telephone and telegraph systems, however, the carrier was direct current, which seemed to put the systems in a different category, while with the wireless telegraph, although the carrier was a high-frequency electromagnetic wave, the modulation resulted from merely interrupting the wave at intervals corresponding to the telegraph code. For the radio telephone, however, there was modulation in the more ordinary interpretation of the term.

Radio transmission is practicable only at high frequencies and the purpose of modulation, of course, is to modify the high frequency in such a way that the voice frequencies may be recovered at the receiving end by available systems of

detection. With modern frequency-modulation, it is the frequency of the carrier that is varied in conformance with the voice wave, but in the earlier system it was the amplitude of the carrier.

### Detection methods

At the time of the early radio-telephone experiments, there were two types of detection commonly used for radio telegraph reception. One employed the coherer, and the other a rectifier. The coherer, under the influence of electromagnetic waves, allowed current to pass through it from a local battery. Its action was qualitative rather than quantitative, since there was no direct relationship between the amplitude of the electromagnetic wave and the amount of current that flowed. It was suitable for telegraph reception since it would differentiate between the presence and absence of a radio signal, which was all that was required. With radio telephony, how-

ever, the radio signal was continuous, and since the problem was to detect variations in it that corresponded to the voice waves, the coherer was not suitable.

A rectifier, however, permitted a quantitative response. Since it blocked the negative halves of the radio waves, a rectified telegraph signal would appear as at A of Fig. 1. When such a series of pulses is impressed across a highly inductive telegraph circuit, the current that flows corresponds to the rms values of the individual pulses, and thus follows the dashed line.

Rectification would thus be suitable for telephone reception if the carrier wave were varied so that its envelope corresponded to the voice wave. A radio wave modified in this way to correspond to a single-frequency voice wave would appear after rectification as at B of Fig. 1, and the current through the inductive telephone circuits would be as represented by the dashed line, which corresponds to the original signal. To secure a modulated wave of this type, what was needed at the transmitting end was some means of varying the amplitude of the radio wave in conformance with the voice wave, and it was this process that was called modulation.

Although a voice wave is ordinarily exceedingly complex in shape, the process and requirements of modulation can be illustrated by considering only a single-frequency

Fig. 1—Rectified telegraph signal at A and rectified telephone signal at B. In each case, the dotted line represents the current in the telegraph sounder or telephone receiver

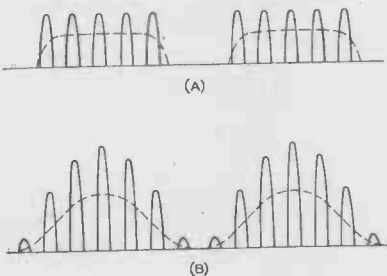

Fig. 2—A low-frequency and carrier wave at A, gives the curve B after modulation. Had the low-frequency wave not been superimposed on a direct current, the modulated wave would have been as at C

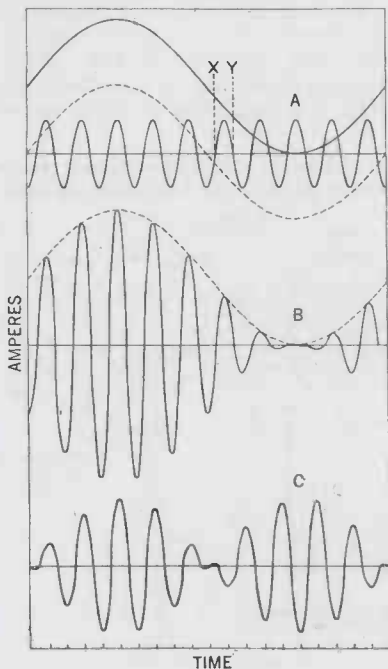
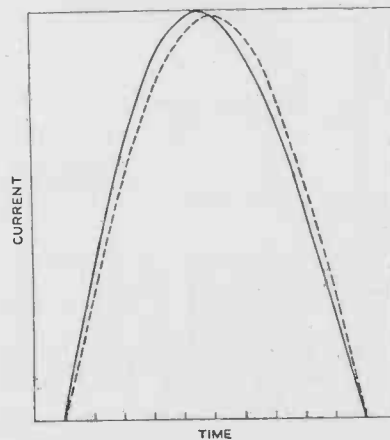

Fig. 3—A half cycle of carrier multiplied by the value of a signal wave that is decreasing results in the solid curve above. The dashed wave is a pure sine wave of the same frequency and amplitude



# MODULATION PROCESSES

wave. Such a wave and the carrier it is to modulate would thus appear as shown by the solid curves at A of Fig. 2. Here the carrier is shown oscillating about the axis of zero voltage, while the voice wave is shown superimposed on a direct current equal to its peak value.

If the value of the carrier at each instant is multiplied by the value of the voice wave at that instant, the resulting curve will appear as the solid curve at B. It is obvious that the envelope of this wave corresponds to the original voice wave as indicated by the dashed line, which could then be recovered by rectification at the receiver. Had the voice wave not been superimposed on a direct current, as indicated by the dashed line at A, the product of voice and carrier waves would give the wave shown at C. The envelope of this latter wave is at double the voice frequency, and thus will not give the voice wave on rectification.

## Variable amplitude

At first, or at least by many engineers, modulation was looked upon solely as a varying of the amplitude of the carrier wave. J. A. Fleming in the 1910 edition of his "Electric Wave Telegraphy and Telephony" speaks of the transmitted waves in wireless telephony as consisting of "oscillations of constant frequency but variable amplitude," and this conception is prevalent throughout the literature of that time. It was thus at least commonly thought that no frequency change was involved in modulation, and for this reason, many felt that the ether could carry an almost unlimited number of telephone conversations, since each required but a single frequency.

Although this conception of modulation seems to be borne out by curve B of Fig. 2, and was essentially correct so far as the process was concerned, it was not quite the correct interpretation of the nature of the modulated wave. What was overlooked, of course, was that the process of varying a current introduced other frequencies, and that it was the combination of the original and introduced frequencies that gave the modulated wave its shape.

If a sine wave such as the carrier of A of Fig. 2 were multiplied by a constant, the result would be a sine wave of the same frequency but different amplitude. If it were multiplied by the voice curve of A, however, the multiplying factor would be different for each point of the carrier wave, and the result is no

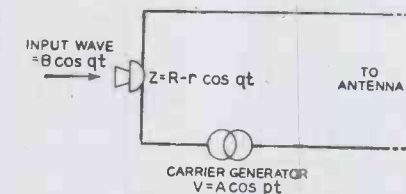

Fig. 4—Modulation by a telephone transmitter as employed in some of the early radio telephone experiments

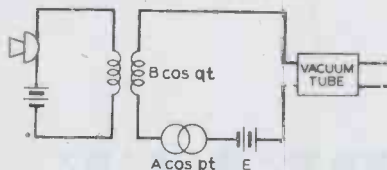

Fig. 5—Radio telephone modulating circuit using a vacuum tube modulator

longer a pure sine wave. This can be shown graphically by plotting the product of the carrier and voice waves over a half-cycle interval, such as that from X to Y. The result is shown in Fig. 3. Here the solid curve at each instant of time is equal to the product of the two waves of Fig. 2.

As a reference standard, a true sine wave of the same frequency and peak value is plotted in dashed lines. It will be noticed that the former curve rises more rapidly, reaches its peak earlier, and then falls more rapidly than the true sine wave. This, of course, is because the value of the voice-frequency wave is greater at the beginning of the carrier cycle than at the end. Had the half cycle chosen been one where the voice wave was rising, the modulated wave would have reached its peak later than the sine wave. Whenever a sine wave is multiplied by a variable rather than a constant, the resulting wave will not be a pure sine wave of the same frequency. Distortion will have been introduced, and a distorted sine wave can always be expressed as the sum of two or more pure sine waves.

This distortion of a wave when it is multiplied by a variable is an inherent and mathematically necessary result, as may be shown by carrying out the multiplication of the mathematical expressions for the two waves. A sine wave may be expressed mathematically as  $K \cos pt$ , where  $p$  is equal to  $2\pi$  times the frequency, and  $K$  is a factor that determines the amplitude. If  $K$  is a constant, it represents the peak value of the wave, which is then a pure single-frequency sine wave reaching  $K$  for each even multiple of  $\pi$ , and  $-K$  for each odd multiple.

When  $K$  is a variable representing a single-frequency sine wave of the form  $(2 + 2 \cos qt)$  as is the solid voice-frequency curve at A of Fig. 2, then the expression for the product becomes  $(2 + 2 \cos qt) \cos pt$ , where  $q$  is  $2\pi$  times the voice frequency  $v$ , and  $p$  is  $2\pi$  times the carrier frequency  $c$ . On multiplication this becomes  $2(\cos pt + \cos pt \cos qt)$ . It may readily be shown, however, that  $\cos x \times \cos y$  is equal to  $\frac{1}{2} [\cos(x + y) + \cos(x - y)]$ , thus the expression for the modulated wave may be written as  $(2 \cos pt + \cos(p + q)t + \cos(p - q)t)$ . The resultant wave thus has components, of three frequencies:  $c$ ,  $c + v$ , and  $c - v$ .

Two sine-wave voltages, such as a voice wave and a carrier-frequency wave, may readily be multiplied algebraically, but no ordinary modulating circuit actually multiplies two voltages. The voltages to be modulated are rather associated in a circuit including an impedance that instead of remaining fixed in value varies with the current through it, or in one way or another can be made to vary in proportion to one or both of the voltages to be modulated. For some of the early work in radio telephony, a telephone transmitter was employed arranged in a circuit as shown in Fig. 4.

The impedance of such a transmitter varies inversely with the pressure on the diaphragm, and under the influence of a single-frequency voice wave may be written  $1(R - r \cos qt)$  where  $R$  is the impedance when no sound is falling on the transmitter, and  $r$  is the maximum change in impedance produced by the voice wave. The current through the transmitter would thus be  $A \cos pt / (R - r \cos qt)$  or  $A \cos pt \times 1 / (R - r \cos qt)$ . Dividing 1 by  $(R - r \cos qt)$  algebraically gives  $1/R \times [1 + r/R \cos qt + (r/R \cos qt)^2 + (r/R \cos qt)^3 \dots]$ .

Since  $r/R$  is small and  $\cos qt$  is never greater than unity, the terms within the bracket become rapidly smaller, and for practical purposes those beyond the second can be assumed to have negligible effect. The modulating current may thus be written as  $1/R \times (1 + r/R \cos qt) \cos pt$ . This is the type of expression that, as has already been shown, yields a modulated wave of the type at B in Fig. 2.

Modulation by use of a telephone transmitter never proved very practicable for radio, however, because

(Continued on page 196)

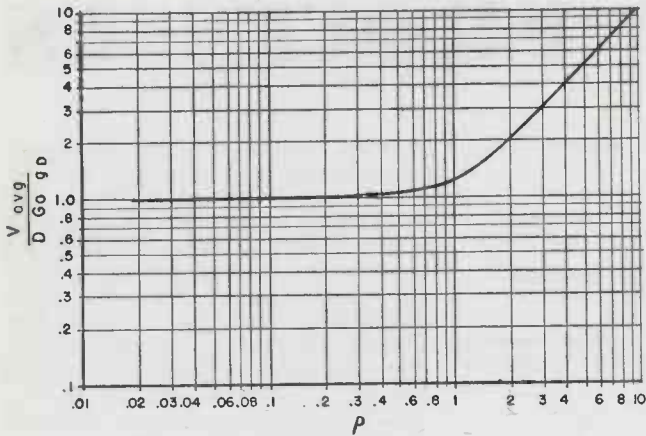

Fig. 1

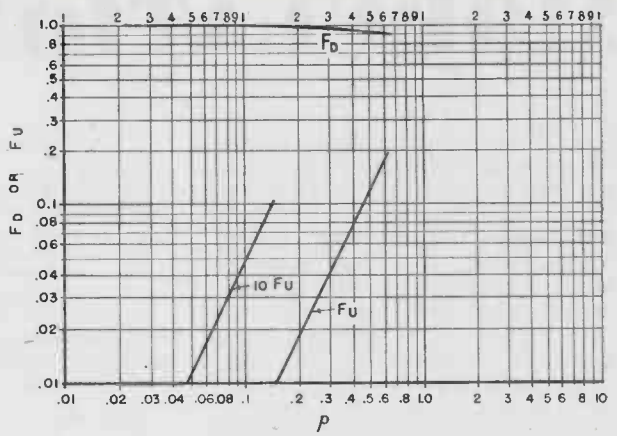

Fig. 2

# INTERFERENCE EFFECTS

By G. F. LEYDORF

Research Consultant  
Crosley Corp., Cincinnati

## Calculating rejection between wanted and unwanted signals for their effect on frequency allocations

● The purpose of this study is to find a means of calculating the interference effects produced by an undesired frequency-modulated signal when a desired frequency-modulated signal is being received. The results are to be applied to various types of receivers in order to estimate the effect of standards of allocation on receiver design, or inversely, assuming a certain type of receiver, to estimate what the allocation standards should be.

Since much of the proposed application will be made to receivers which do not limit or at signal levels where limiting is not effective, it is assumed that limiting does not take place. Under these circumstances interference rejection takes place due to the following effects:

- The selectivity of the tuned circuits in the if amplifier and discriminator;
- The relative decrease in slope of the tuned circuit and discriminator characteristics at frequencies removed from the desired frequency;
- The masking effect of the detector circuits;
- The use of a balanced circuit in the discriminator.

The interference rejection due to effects (A) and (B) are apparent and do not require special consideration. These effects will be evi-

dent in the expressions obtained under (C) and (D).

### Masking effect

The masking effect of a detector circuit when two signals are present is at a maximum when the time constant of the RC circuit is small enough to allow the developed voltage to vary at the heterodyne frequency. If the undesired signal is small in comparison with the desired signal at the input to the detector, the heterodyne voltage developed will be approximately sinusoidal and the average voltage will be very slightly affected by variations in amplitude of the undesired signal. This can be shown as follows:

The amplitude  $V_D$  of the desired signal and the amplitude of the undesired signal,  $V_U$ , at the detector will be:

$$V_D = DG_D g_D \sin \omega_D t \quad (1)$$

$$V_U = UG_U g_U \sin \omega_U t \quad (2)$$

Where

$D$  is the desired signal input voltage

$G_D$  is the gain of the set exclusive of the discriminator at the desired signal frequency

$g_D$  is the gain of the discrimi-

nator circuit at the desired signal frequency

$G_U$  is the gain of the set exclusive of the discriminator at the undesired signal frequency

$g_U$  is the gain of the discriminator at the undesired signal frequency

$\omega_D$  is  $2\pi \times$  desired signal frequency

$\omega_U$  is  $2\pi \times$  undesired signal frequency.

The total voltage at the detector will be:

$$V_T = V_D + V_U = DG_D g_D [\sin \omega_D t + p \sin \omega_U t]$$

$$\text{where } p = \frac{UG_U g_U}{DG_D g_D} \quad (3)$$

This total signal is a combined amplitude and phase modulated signal. The form of the expression for  $V_T$  can be changed, by means of trigonometric identities to:

$$V_T = DG_D g_D \sqrt{1 + p^2 + 2p \cos \theta} \sin (\omega_D t + \psi)$$

$$\text{where: } \theta = (\omega_U - \omega_D) t \quad (4)$$

$$\psi = \tan^{-1} \left( \frac{p \sin \theta}{1 + p \cos \theta} \right)$$

For a very small  $p$ , the radical is approximately  $1 + p \cos \theta$ , an ordinary amplitude modulation coefficient, the frequency of the modu-

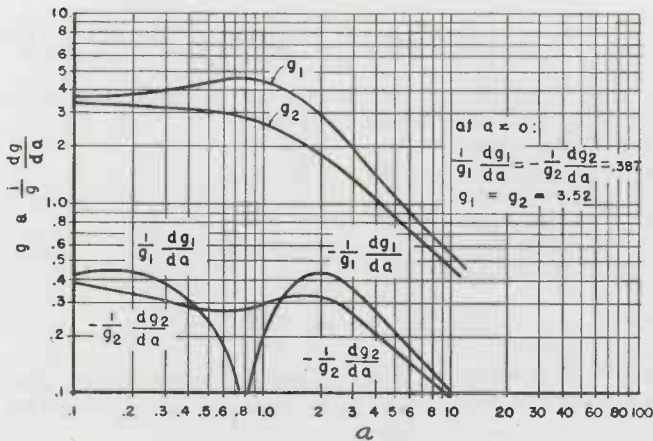

Fig. 4—Discriminator characteristics

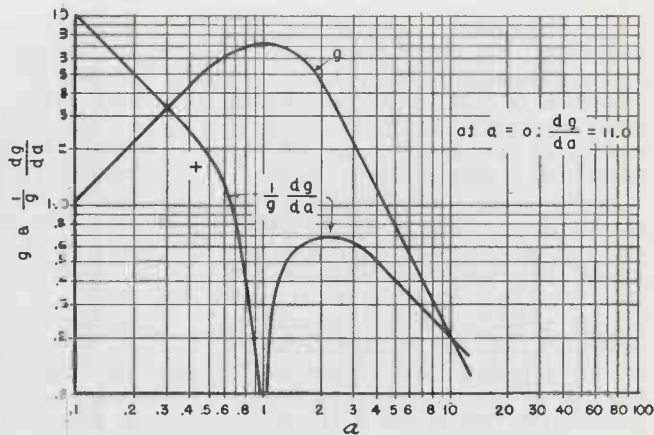

Fig. 5—Discriminator characteristics

# in FM WITHOUT LIMITING

lation being  $\frac{\omega_U - \omega_D}{2\pi}$ , the heterodyne

frequency. Also for small  $p$ , the phase angle is approximately  $p \sin(\omega_U - \omega_D)t$  radians, corresponding to phase modulation at heterodyne frequency.

The heterodyne frequency is usually considerably above audibility and when this is the case, it can be filtered out later. If the time constants of the RC circuit in the detector are small enough the envelope of the combined wave will be reproduced, and the average value of this voltage will be very nearly independent of the magnitude of  $p$  when  $p$  is small.

Now when the frequency of the undesired signal is changed,  $p$  will change slightly since  $G_U$  and  $g_U$  are functions of frequency. The change in  $p$  will change the average value of the combined amplitude. The amount of this change in comparison with the change in the average value of the envelope due to an equal change in the desired signal frequency is the measure of the rejection of the unwanted signal.

The magnitude of the envelope is the coefficient of  $\sin(\omega_D t + \psi)$ . That is:

$$V_{Te} = DG_D g_D \sqrt{1 + p^2 + 2p \cos \theta} \quad (5)$$

The average value of the envelope is

$$V_{avg} = \frac{1}{\pi} \int_0^\pi V_{Te} d\theta = DG_D g_D \frac{1}{\pi} \int_0^\pi \sqrt{1 + p^2 + 2p \cos \theta} d\theta$$

$$= DG_D g_D \frac{2}{\pi} (1 + p) \int_0^{\pi/2} \sqrt{1 - \frac{4p}{(1+p)^2} \sin^2 \phi} d\phi \quad (6)$$

Hence:

$$V_{avg} = DG_D g_D \frac{2}{\pi} (1 + p) E(k) \quad (6a)$$

where  $E(k)$  is the complete elliptic integral of the second kind  $k = \frac{2\sqrt{p}}{1+p}$

On Fig. 1 the function  $\frac{2}{\pi} (1 + p) E$

$$V_{AD} = D \frac{d}{df_D} (G_D g_D) \frac{1}{\pi} \{ (E + K) + p(E - K) \} \Delta f_D = D \frac{d(G_D g_D)}{df_D} F_D(p) \Delta f_D$$

where  $F_D = \frac{1}{\pi} \{ (E + K) + p(E - K) \}$  (7)

is plotted against  $p$ . Here it will be noted that  $V_{avg}$  is increased by 5%, (1/20), when  $p$  is approximately 0.4. Since  $p$  is the ratio of the amplitude of the undesired to that of the desired signal at the detector, this indicates that roughly speaking the undesired signal should be 8 db weaker than the desired signal. Slope considerations modify this estimate both upward and downward. Adjacent to the peak of the discriminator characteristic,  $p$  must be about .2 (14 db down), while for undesired frequencies several bandwidths away  $p \approx .6$  (4 db down) is sufficient. The slope is considered in following paragraph.

The change in  $V_{avg}$  when the frequency

of the desired signal is changed, is proportional to the audio voltage developed by FM, and is:

$$V_{AD} = \frac{dV_{avg}}{df_D} \Delta f_D = D \left[ \frac{2}{\pi} (1 + p) E \frac{d}{df_D} (G_D g_D) + G_D g_D \frac{d}{dp} \left\{ \frac{2}{\pi} (1 + p) E \right\} \frac{dp}{df_D} \right] \Delta f_D$$

Where

$f_D$  is the desired signal frequency

$\Delta f_D$  is the change in desired signal frequency.

Evaluating the deviations, one obtains:

$E$  is the elliptic integral of the second kind and argument  $k$ .

$K$  is the elliptic integral of the first kind and argument  $k$ .

$$k = \frac{2\sqrt{p}}{1+p}$$

The change in  $V_{avg}$  when the frequency of the undesired signal  $f_U$  is changed by  $\Delta f_U$  is:

$$V_{AU} = \frac{dV_{avg}}{df_U} \Delta f_U = DG_D g_D \frac{d}{dp} \left[ \frac{2}{\pi} (1 + p) E \right] \frac{dp}{df_U} \Delta f_U$$

$$= DG_D g_D \left( \frac{1}{g_U} \frac{dg_U}{df_U} + \frac{1}{G_U} \frac{dG_U}{df_U} \right) \frac{1}{\pi} \{ (E - K) + p(E + K) \} \Delta f_U$$

$$= DG_D g_D \frac{1}{g_U G_U} \frac{d}{df_U} (g_U G_U) F_U(p) \Delta f_U \quad (8)$$

$$\text{where } F_U = \frac{1}{\pi} \{ (E - K) + p(E + K) \}$$

When  $p$  is small:  $F_D \approx 1$   
 $F_U \approx \frac{p^2}{2}$

The functions  $F_D$  and  $F_U$  are plotted on Fig. 2. Examination of these functions shows that the presence of the undesired signal has only a slight effect on the sensitivity of the detector to the desired signal provided  $p$  is small.

In the usual form, the frequency modulation detection system utilizes a common amplifier and a balanced discriminator arranged so that the slope of the characteristic of one branch is equal in magnitude but opposite in sign to slope of the characteristic of the other branch at the desired signal frequency. On Figs. 3 and 4 are shown the experimental curves for a Seeley type discriminator obtained at a frequency of 10.2 mc/s. These curves are plotted in terms of the parameter

$$a = \frac{f - f_D}{\frac{1}{2}W} \quad (9)$$

Where

$f$  is the resonant discriminator frequency

$f_D$  is the desired signal frequency

$W$  is the difference in frequency between the peaks of the overall discriminator characteristics.

In the center of Fig. 3 the response of each diode and the overall response is calculated for three conditions:

A. When a single signal is varied in frequency. This is the usual characteristic.

B. The response for a signal of fixed frequency plus an equal

signal of frequency corresponding to a.

C. The response for a single signal of fixed frequency ( $a = 0$ ) plus a signal of half the amplitude of the fixed signal which is varied in frequency.

In each case, A, B or C, the amplitude of the signals at the input to the discriminator is held constant. These curves show the masking effect.

These curves, Figs. 3 and 4, will be used in the sample calculations later on. The selectivity characteristics used in examples will be Kilgour's\* curves which are also plotted in terms of the parameter  $a$ . (Figure 8, from Kilgour's report, is attached for convenience.)

The outputs of the two branches of a balanced discriminator are connected in series opposition. This makes the audio output of the two

$$V_{AD} = D \left\{ \frac{d}{df_D} (G_D g_{D1}) F_D(p_1) - \frac{d}{df_D} (G_D g_{D2}) F_D(p_2) \right\} \Delta f_D \quad (10)$$

Since  $G_D$  is substantially constant near  $f_D$ ,

$$\frac{dg_{D1}}{df_D} = \frac{dg_{D2}}{df_D}, \text{ and}$$

$$F_D \approx 1, \quad (10a)$$

$$V_{AD} \approx 2DG_D \frac{dg_{D1}}{df_D} \Delta f_D$$

The undesired signal audio output corresponding to a deviation  $\Delta f_U$  is:

$$V_{AU} = DG_D g_D \left\{ \frac{F_U(p_1)}{G_U g_{U1}} \frac{d}{df_U} (G_U g_{U1}) - \frac{F_U(p_2)}{G_U g_{U2}} \frac{d}{df_U} (G_U g_{U2}) \right\} \Delta f_U \quad (11)$$

$$\text{where } p_1 = \frac{UG_U g_{U1}}{DG_D g_{D1}} \quad p_2 = \frac{UG_U g_{U2}}{DG_D g_{D2}}$$

The ratio of desired audio output to undesired audio output for equal small frequency deviations  $\Delta f_D = \Delta f_U$  is:

$$r = \frac{V_{AD}}{V_{AU}} = \frac{2 \frac{1}{g_D} \frac{dg_D}{df_D}}{F_U(p_1) \left[ \frac{1}{G_U} \frac{dG_U}{df_U} + \frac{1}{g_{U1}} \frac{dg_{U1}}{df_U} \right] - F_U(p_2) \left[ \frac{1}{G_U} \frac{dG_U}{df_U} + \frac{1}{g_{U2}} \frac{dg_{U2}}{df_U} \right]}{2 \frac{d}{df_D} (\ln g_D)}$$

$$= \frac{F_U(p_1) \left[ \frac{d}{df_U} (\ln G_U) + \frac{d}{df_U} (\ln g_{U1}) \right] - F_U(p_2) \left[ \frac{d}{df_U} (\ln G_U) + \frac{d}{df_U} (\ln g_{U2}) \right]}{2 \frac{d}{da_D} (\ln g_D)} \quad (12a)$$

branches additive (because of slopes of opposite sign), in the de-

In terms of the parameter "a" the ratio is

$$r = \frac{2 \frac{d}{da_D} (\ln g_D)}{F_U(p_1) \left[ \frac{d}{da_U} (\ln G_U) + \frac{d}{da_U} (\ln g_{U1}) \right] - F_U(p_2) \left[ \frac{d}{da_U} (\ln G_U) + \frac{d}{da_U} (\ln g_{U2}) \right]} \quad (12b)$$

$$a_U = [f_U - f_D] / \frac{1}{2}W; \quad a_D = 0$$

sired signal range, and subtractive when the slopes are of the same sign outside this range. This connection also tends to minimize the sensitivity to undesired signals caused by the slope of the amplifier gain characteristic.

The quantities associated with one discrimination branch will be identified with the subscript (1) and the quantities associated with the other branch will be identified with the subscript (2).

Then the audio output corresponding to a deviation  $\Delta f_D$  of the desired signal is:

All quantities of which derivatives are taken are logarithmic. Hence if these quantities are plotted on logarithmic paper, with the same length of cycles in each direction the desired derivative is simply the slope of the curve divided by "a".

$$\frac{d}{da} (\ln g_{U1}) = \frac{\text{slope of curve of } g_{U1} \text{ vs. } a \text{ (log-log paper)}}{a_U}$$

When the gain characteristics are plotted in the form:

$$g(\text{db}) = 20 \log_{10} \frac{G_D}{G_U} = 8.68 \ln \frac{G_D}{G_U};$$

$$\text{then } \frac{d}{da_U} (\ln G_U) = - \frac{1}{8.68} \frac{dg}{da_U}$$

Fig. 3—Discriminator characteristics measured at 10.2 mc and calculated response under masking conditions

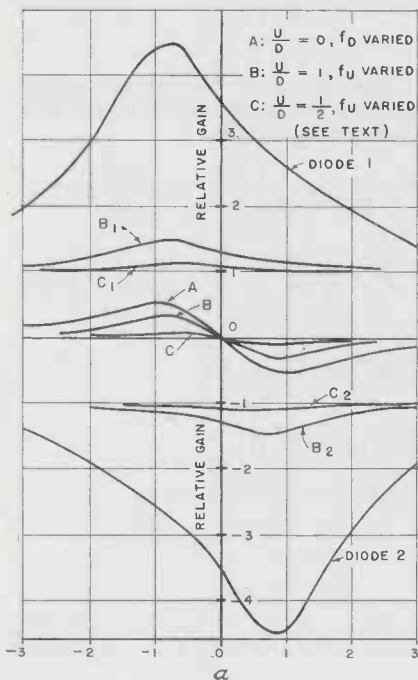

\*"Design Data for the Double Tuned Interstage Transformer," C. E. Kilgour, 9/29/44.



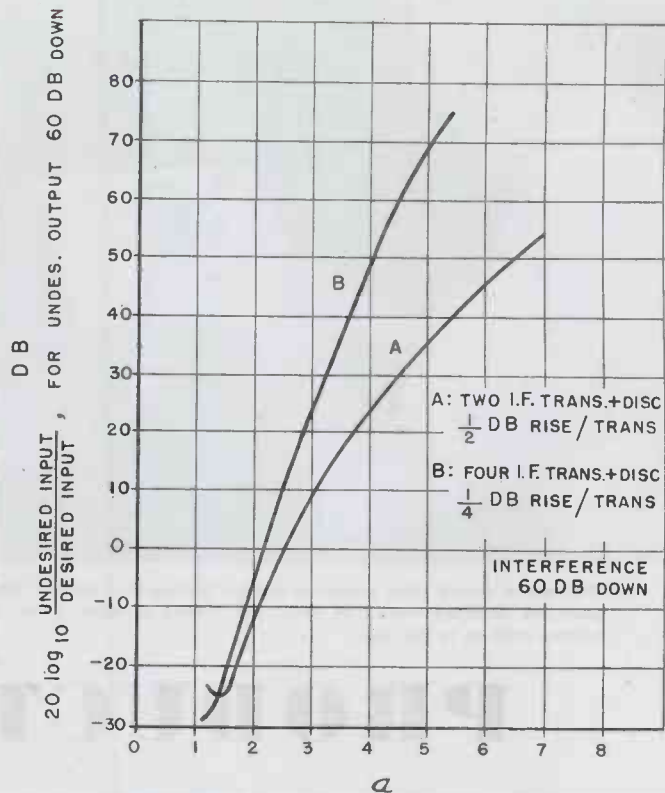
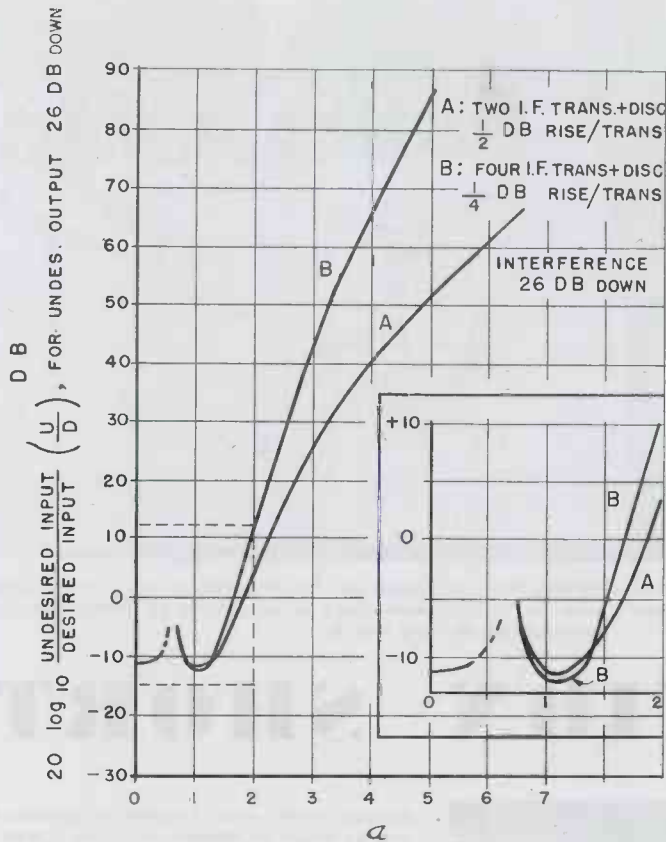

Fig. 6—(Left) Calculated selectivity of FM signals under masking conditions. Inset is identical with section within dashed line  
Fig. 7—Calculated selectivity of FM signals under masking conditions

Furthermore, if the amplifier consists of  $M$  identical stages of gain  $G$ , then

$$G = g^m, \quad \ln G = m \ln g$$

$$\text{and } \frac{d}{da}(\ln G) = \frac{d(\ln g)}{da} \times n$$

Over the range of usual calculations  $F_v$  is very nearly equal to  $\frac{1}{2}p^2$ . With this approximation, (12b) becomes:

$$r = \frac{p_1^2 \left[ \frac{d(\ln g_{D1})}{da_D} \right]}{p_1^2 \left[ \frac{d}{da_U}(\ln G_U) + \frac{d}{da_U}(\ln g_{U1}) \right] - p_2^2 \left[ \frac{d}{da_U}(\ln G_U) + \frac{d}{da_U}(\ln g_{U2}) \right]} \quad (12c)$$

When the time constant of the RC circuit of the detector is such that only the peak of the combined envelope is followed, then

$$V_{avg} = DG_D g_D (1 + p) \quad (13)$$

The output of a balanced discriminator in this case is simply:

$$V_{AD} = DG_D \frac{d}{da_D} (g_{D1} - g_{D2}) \Delta a_D \quad (14)$$

$$V_{AU} = U \left[ G_U \frac{d}{da_U} (g_{U1} - g_{U2}) + (g_{U1} - g_{U2}) \frac{dG_U}{da_U} \right] \Delta a_U \quad (15)$$

This is most easily derived without using  $p$ . The ratio of desired to undesired audio signals for equal deviations now is:

$$r = \frac{V_{AD}}{V_{AU}} = \frac{DG_D}{UG_U} \frac{1}{g_U} \times \frac{\frac{dg_D}{da_D}}{\frac{d}{da_U}(\ln g_U) + \frac{d}{da_U}(\ln G_U)} \quad (16)$$

where

$g = g_1 - g_2$  is the overall characteristic of the discriminator

$g_D$  is the value of  $g$  at the desired signal frequency

$g_U$  is the value of  $g$  at the undesired signal frequency

The overall characteristics of the discriminator are shown on Fig. 5.

### Sample calculations

Formula (12c) has been applied to find the allowable undesired to desired signal input ratio for two types of receivers.

- Two I.F. transformers plus discriminator (Six tuned circuits)

- Four I.F. transformers plus discriminator (Ten tuned circuits)

The ratio of the inputs of undesired to desired signals is one such that the undesired audio signal in the output is a specified number of decibels below the audio of the desired signal for equal small deviations. Two output ratios were specified: 26 db down corresponding to the value commonly used in allocation problems; and 60 db down, which is probably as much as will ever be desired.

The results are shown on figures 6 and 7. Only one-half of the curves are shown since calculated curves are very nearly symmetrical.

Fig. 8

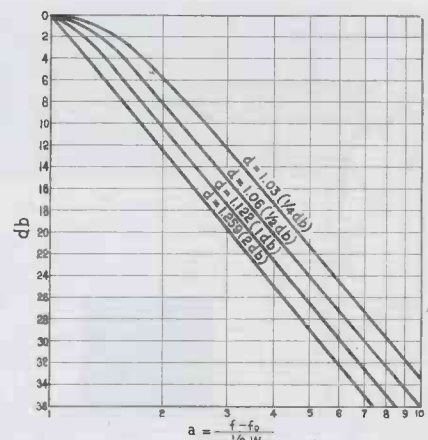

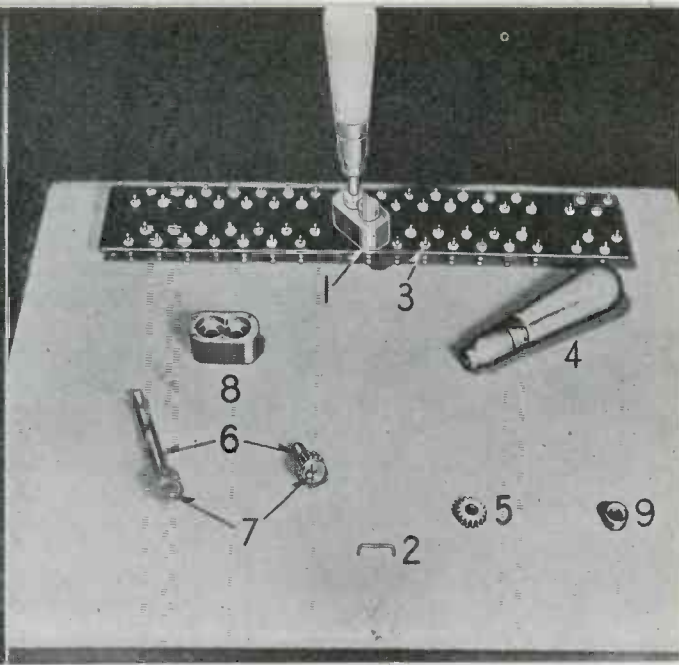

Illuminated ground glass inspection surface developed at General Electric plant for checking angles on tools and cutters is much better than holding work up to the light

Twirling the handle causes pins 7 to wrap ends of wire 2 around adjacent posts on terminal board. Used to set quantity of identical jumpers at Westinghouse Elec. and Mfg. Co.

# PRODUCTION SHORT

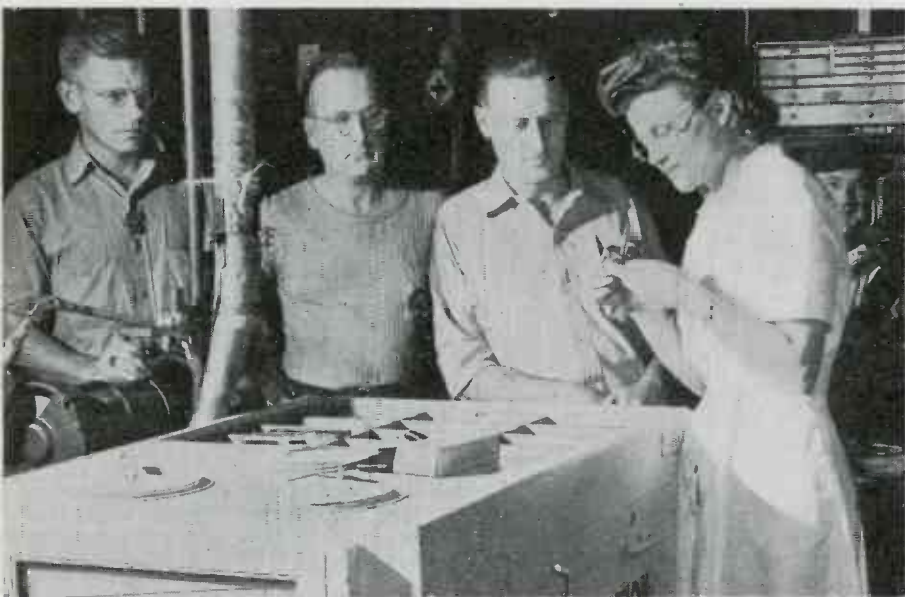

Bringing safety eyeglass repairs to production area by means of "Goggle cart," also a Westinghouse idea, keeps glasses in use and materially cuts eye injuries

Cooling transformers in dry ice 20 minutes, then holding in water half a minute quickly reveals pin holes in hermetic seals without damage. Simulates five cycle test

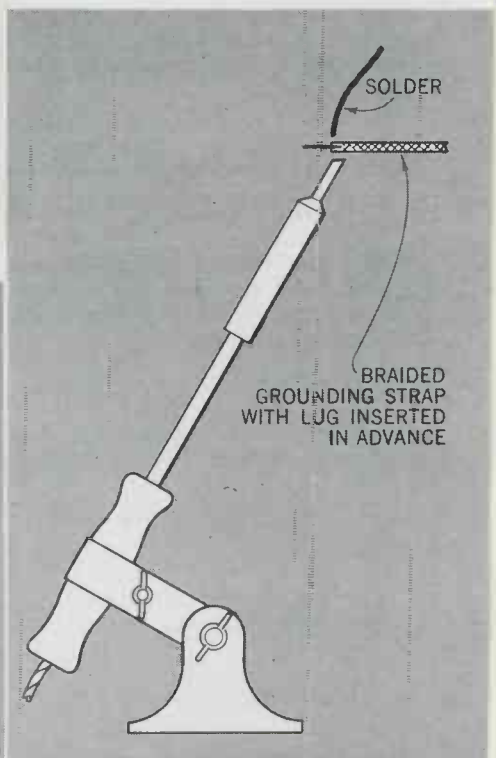
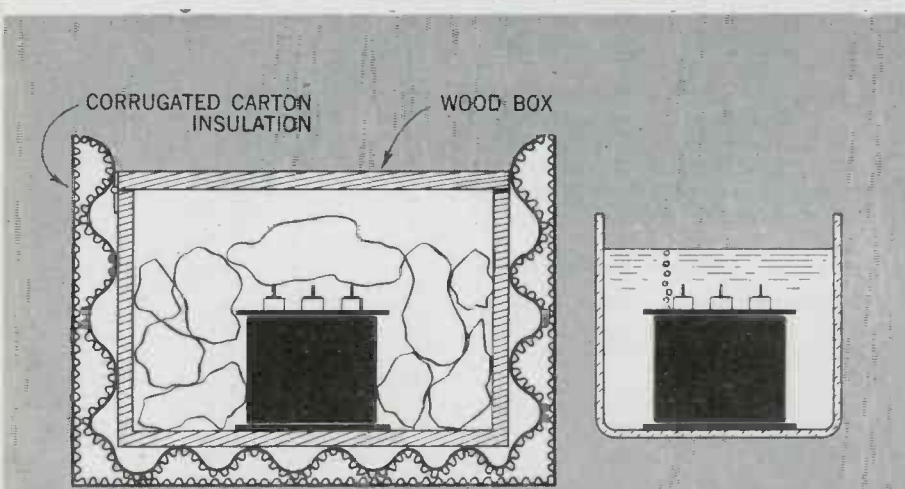

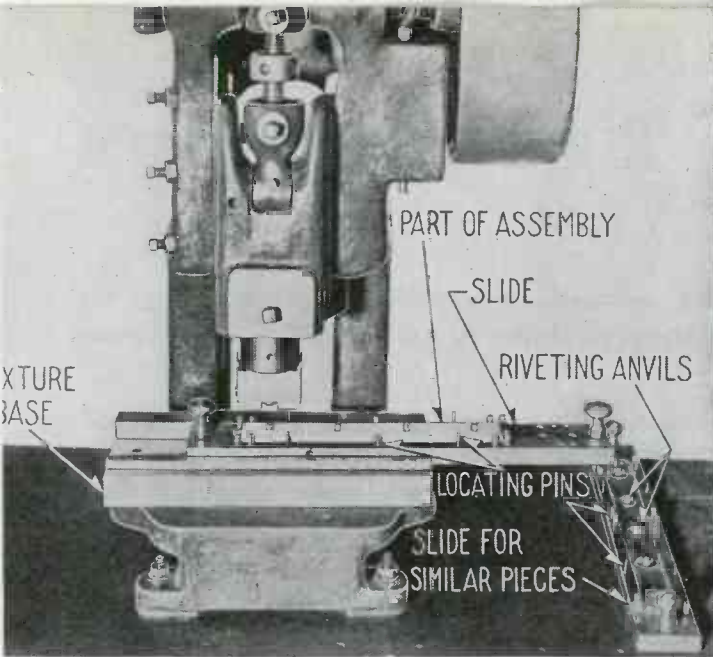

Heading many in-line rivets is eased by a slide with multiple anvils at the Westinghouse Sunbury plant. Spring loaded balls rise into counterbores for right location

## CUTS

Bending tube lead-in wires to exact angles is speeded up and facilitated by the use of a specially designed production jig, (upper right) developed in North American Philips, Dobbs Ferry plant

Resting plug gages on oil soaked felt strips when not in use solves oiling and cleaning problem. Only a turn is needed before use

Benches with only central legs (umbrella type) save 30 per cent space at General Electric Schenectady works. (Lower right) cleaning is also facilitated

Neat soldering of lugs to braided ground strap is simplified by working on top of the iron as shown (left). High visibility is a feature

Drilling holes in large work is accomplished on a bench drill (below) at Westinghouse plant. Head is turned away from table and cup saw is used, making neat hole

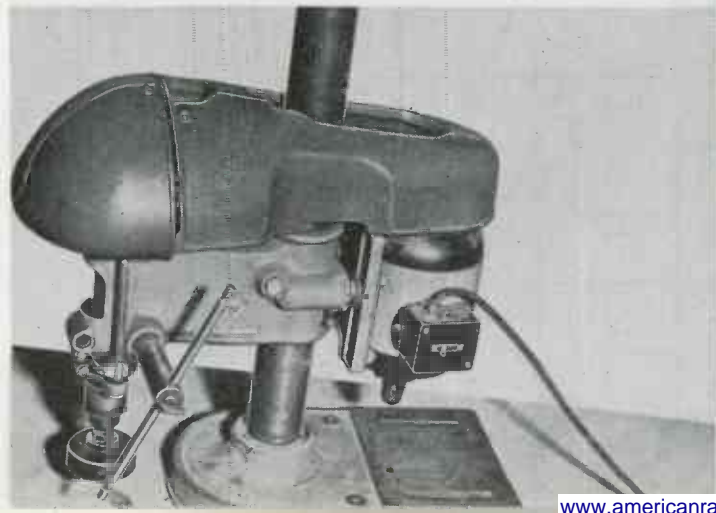
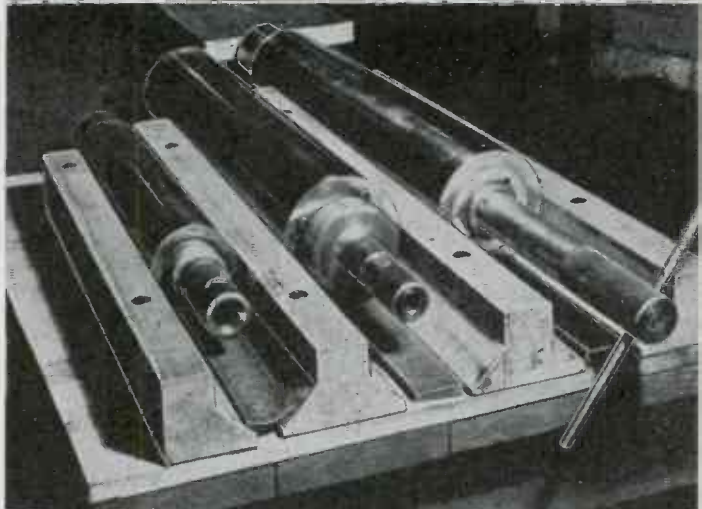

# MAGNETRON Frequencies

By E. DJAKOV and A. RAEV\*

## Dependence of resonance oscillation frequency on magnetic and electric fields in split-anode magnetrons

• The article reports some experimental results on resonance oscillations in magnetrons at magnetic field intensities greater than the critical field.<sup>1</sup> The dependency of the oscillation frequency on the operating conditions, such as magnetic and electric field intensities, is investigated. The frequency is not influenced by the load circuit.

Most of the measurements were made on one four-segment magnetron with an anode radius of 0.5 cm (type MV 50/25 Telefunken) and the relations found were tested on another magnetron of the same type and on one with an anode radius of 0.4 cm. Two two-segment magnetrons with an anode radius of 0.4 cm were also investigated.

The external load circuit was either an aperiodic circuit consisting of chokes and resistors or an unloaded Lecher wire system (Fig. 1). The wavelength was indicated by a loosely coupled resonant-circuit detector connected to a galvanometer ( $4.5 \times 10^{-9}$  amp per degree). The rectified current in an aperiodic detector circuit, measured with the same galvanometer, was used as a relative measure for the oscillation intensity.

For a variable magnetic field  $H$ ,

constant anode voltage  $V$ , and aperiodic load circuit, the wavelength magnetic field relation for the four-segment magnetron consists of two straight lines (Fig. 2). This indicates the simultaneous presence of two oscillations for which the wavelengths,  $(\lambda_1)$ ,  $(\lambda_2)$ , are proportional to the magnetic field intensity  $H$ . For constant  $H$  (Fig. 3), two hyperbolic curves were found to represent the dependence of the wavelength on the anode voltage, showing that the wavelengths,  $(\lambda_1)$ ,  $(\lambda_2)$ , are inversely proportional to the anode voltage  $V$ .

From many measurements with widely varying values for  $V$  and  $H$ , the mean value of  $\lambda_1 V/H$  for the longer wavelength  $\lambda_1$  was found to be equal to 175; for the shorter wavelength  $\lambda_2$  the expression  $\lambda_2 V/H$  is equal to 101. Measurements on the four-segment magnetron with anode radius  $a = 0.4$  cm gave  $\lambda_1 V/H = 110$  and  $\lambda_2 V/H = 59$ , indicating a square law dependence of the wavelength on the anode ra-

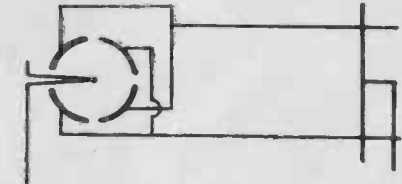
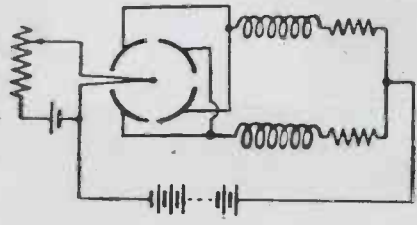

Fig. 1—Magnetrons loaded with periodic circuit or with Lecher wire system

Fig. 2—Wavelength as function of magnetic field intensity: Four-segment magnetron, aperiodic load circuit, emission current: 77 ma,  $r=0.5$  cm.,  $V=400$  volts

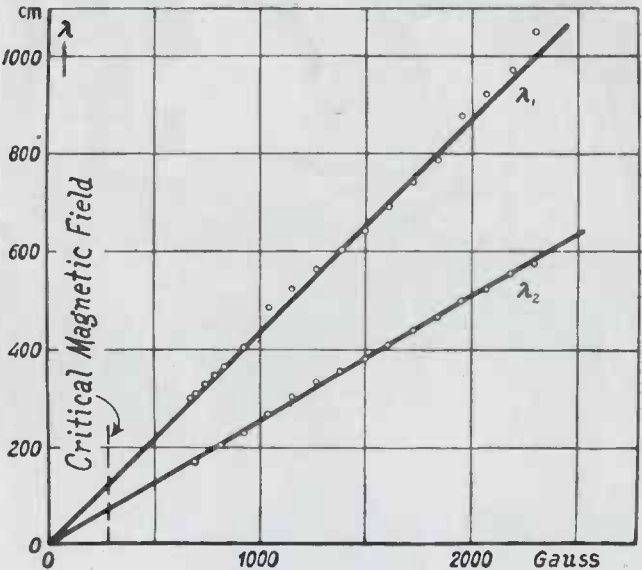
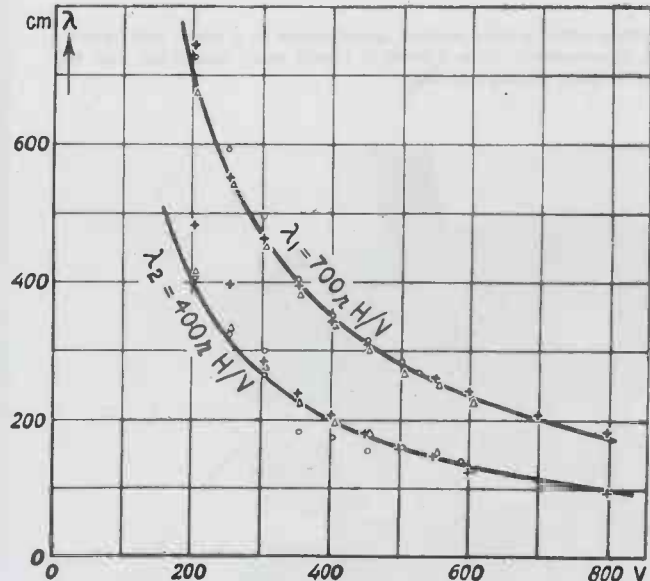
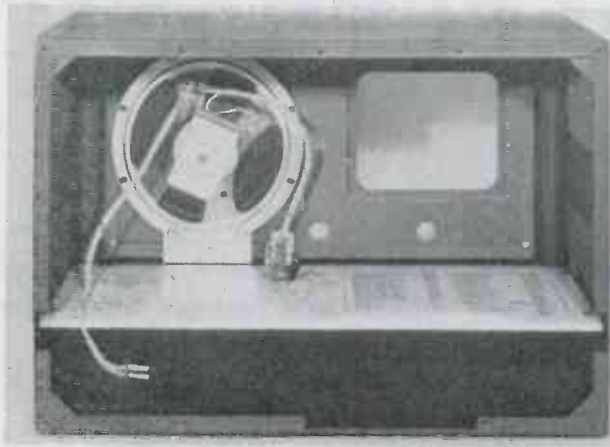

Fig. 3—Wavelength as function of anode voltage: Four-segment magnetron, aperiodic load circuit  
 + Lecher wires with resonant wavelength greater than oscillation wavelength,  
 Δ Lecher wires with resonant wavelength smaller than oscillation wavelength,  
 emission current: 60 ma,  $r=0.5$  cm.,  $H=800$  gauss



(Continued on page 200)



Rear view of the receiver showing the construction by which the chassis and the battery holder are slid into the cabinet

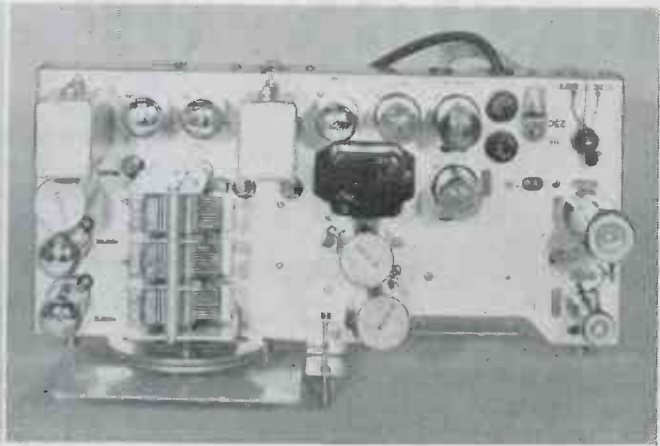

R-1/URR radio receiver chassis which provides for reception on three bands using either self-contained batteries or ac-dc

## 3-BAND "MORALE" SET

● Substantial quantities of a three-band broadcast unit called a "morale receiver" are being made by several manufacturers and distributed to the Armed Forces of the United States to permit them to listen to any available entertainment programs when they are at liberty. The receiver is compact and has been designed with an eye to maximum usefulness under all sorts of conditions.

This set, model R-100/URR is an ac-dc, battery set. Two 45-volt and two 1.5-volt batteries will operate it, or it can be run from 105 to 125 volt, or 210 to 250 volt 25 to 60 cycle or from dc mains. Frequencies covered are: Band 1—540 to 1550 kc; Band 2—3.6 to 8.5 mc; Band 3—8.4 to 19 mc. A band switch changes from one set of coils to

another. In addition to frequency markings on the dial, there is a logging scale divided 0 to 100.

The sensitivity over the entire range is not less than 10 microvolts with a 50 milliwatt output, and under this condition, the signal to noise ratio is a minimum of 10/1. There is a permanent magnet speaker in the metal housing cabinet as well as a phone output jack. The cabinet is entirely insulated from the grounded chassis. The latter is provided with ground and antenna posts, and 25 ft. of insulated antenna wire are supplied, with a frame for winding it up when not in use. The assembly is moisture and fungus proofed and built to JAN specifications.

The set is a superheterodyne with one antenna circuit, one rf

and two if circuits, one combination detector and first audio amplifier and one output tube. The tube complement for battery operation consists of three 1LN5, one 1LC6, one 1LH4 and one 3Q5 for output. For ac-dc operation, the 3Q5 is dropped out and a 25L6 substituted, while a 25Z6 rectifier is added. During operation from the mains the filament supply is obtained from the drop across the cathode of the 25L6.

The band width of the if circuits is 7 kc at two times down from peak, and 60 kc at 1,000 times down. The image frequency rejection ratio is 50/1, while the if rejection ratio is 4000/1. The if coils are permeability tuned. Battery styles used are two BA36 and two BA23-U, which fit into the cabinet.



Front view of receiver, showing range changing control for the three bands, headphone jack and loud speaker; cabinet is metal



Rear view of receiver showing compartment open for access to line cord, and the built-in reel for storing the antenna wire

# DESIGN OF ELECTRONIC

By **WESLEY M. ROBERDS**

Engineering Department  
Radio Corp. of America, Camden, N. J.

**Problems of designers will be eliminated as plans of recognized procedure are established by manufacturers**

● To engineers who are accustomed to see powerful broadcast equipment, industrial oscillators appear amazingly simple. It is customary to use only one or two power tubes which act as self-excited oscillators. These, together with the usual six rectifier tubes, constitute the entire tube complement. The transmitter engineer indeed, finds it difficult to adapt his thinking to the design of these equipments because the purpose, and therefore the requirements, are so different from those of communication apparatus.

The elements which go to make a good transmitter are often undesirable in an industrial oscillator. For example, in the latter equipment shielding is extremely important in order to prevent radiation; on the other hand, frequency stability is not at all important. As a load heats, its electrical characteristics change and these changes are reflected into the oscillator where they may cause frequency variations of several per cent. Heating efficiency varies extremely slowly with frequency, so that small frequency variations are negligible. Therefore, as long as there is sufficient shielding to prevent interference with communication, the frequency of the industrial oscillator may vary at will. Moreover, the waveform generated by the industrial oscillator is also unimportant.

For factory and shop equipment the fewer the meters and controls

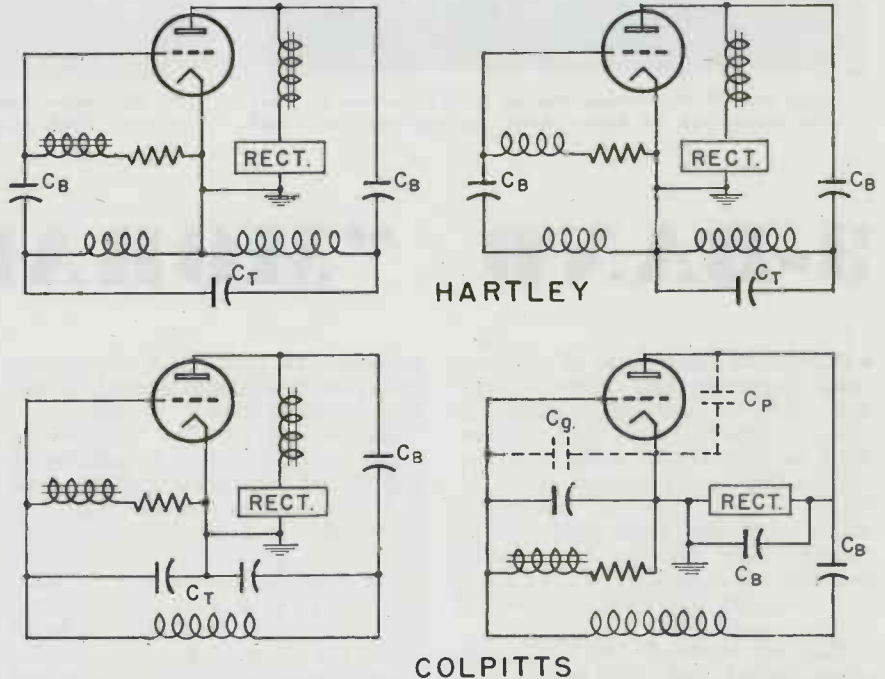
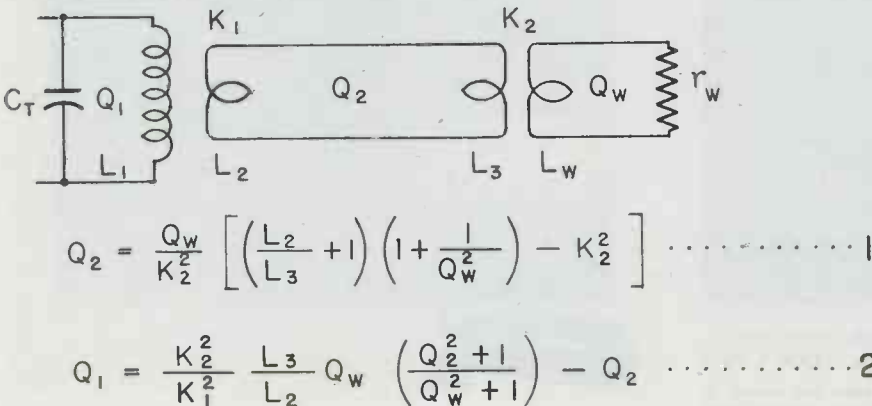

Fig. 1—Of the two circuits generally used for the generation of high frequency heating currents, the Colpitts is the simpler though its cost, in view of the bank of capacitors required, is likely to be higher than the Hartley

the better. Also, it is preferable that any necessary meters be kept out of sight as much as possible. As one shop superintendent put it, "When an operator sees a lot of meters and control knobs, he is either scared to death or fancies himself a radio engineer." Industrial heating equipment should be

the epitome of rugged power. It should be able to take a terrific beating and at the same time be able to "dish out" the power day after day without attention. If it does that, the owner will not even see the color, and its shape is quite immaterial just as long as it takes up a minimum of space.

Fig. 2—Schematic presentation of a generally used type of coupling system for transferring energy from the generator to a load circuit



### Types of cooling

In recent years designers of radio transmitters have been using air cooling as much as possible. This type of cooling also has many advantages for industrial hf generators. It allows the equipment to be portable and there is no danger of water-cooling systems becoming clogged with scale. However, there are important considerations which favor water cooling in industrial equipments. In spite of the scale-forming tendency, the water supplies of most industrial plants are cleaner than the air. Moreover, power tubes when water-cooled, generally have much higher power

# HEATING GENERATORS

rating than the equivalent air-cooled tubes.

Another advantage of water cooling for industrial equipment lies in the reduction in size which it makes possible. A capacitor which has been designed to take full advantage of water cooling has one-third to one-fourth the volume of an equivalent air-cooled capacitor. A conductor designed to carry 200 amperes of hf current with air cooling is generally a two-inch copper pipe. On the other hand, if water cooling is used, the conductor can be  $\frac{1}{4}$  in. to  $\frac{3}{8}$  in. in diameter.

Probably the best argument for using water cooling in induction-heating equipment is the fact that water must be used to cool the applicator coil. Since this coil must be of small diameter in order to couple to the work and yet must carry currents in the order of 1,000 amperes, water cooling is absolutely necessary. Therefore, since some water cooling is mandatory, it seems reasonable that water cooling should be used throughout. Very likely water will be used for the more powerful and bulky equipment, while air cooling will be provided in the smaller, portable sets.

## Power tubes

With the possible exception of the Allis-Chalmers gas tube, there are at present no power tubes

which have been developed specifically for industrial heating purposes. It is true that the modern transmitting tubes work very well as power sources in industrial oscillators. Moreover, it is likely that for work in the megacycle frequencies those characteristics which are desired in a tube for industrial heating are also those desirable for a high-frequency transmitter. It is reasonable to suppose, however, that if a tube were designed specifically for such a job as induction heating, it could be made more cheaply and it would have more desirable characteristics than those used for communication purposes.

## The circuit

The oscillating circuit should, of course, be the simplest possible. There are two circuits which are electrically equivalent in this respect. They are the Colpitts and the Hartley. When condensers can be obtained which have been designed specifically for a given generator then the Colpitts type is physically simplest and "cleanest." However, when one must build up, from commercial units, a capacitor bank which has the proper capacity, current carrying ability, and voltage rating, the over-all size and cost of the Colpitts circuit is likely to be greater than that of a Hartley circuit.

The principal difference between

these two circuits is that in the Colpitts a ground tap is placed in the condenser limb of the oscillating circuit, while in the Hartley the tap is on the inductance limb. In most induction heating equipment it is generally easier, physically, to make the tap in the condenser. Of course, there are many variations of these two circuits which can be made up to suit a particular purpose.

In an oscillator operating at ten megacycles or above, it is desirable to make use of the plate-to-cathode and grid-to-cathode capacities in the tube as part of the tank capacity. In this case the Colpitts is the natural circuit. (Fig. 1) It is generally necessary, however, to add capacity in parallel with the grid capacity in order to adjust the excitation of the tube. At lower frequencies some capacity may also be added to the plate-to-cathode capacity.

## Tank circuit impedance

In small radio circuits, where maximum power output is not an important consideration, the designer may shift his capacity or inductance almost at will to obtain a desired frequency. This cannot be done, however, in the design of power-generating equipment. Let us take a specific example to illustrate the point. It is easily shown that the KVA ratio of a circuit

$\frac{EI}{P}$  (—) is equivalent to the quantity  $Q$  which by definition is the ratio of the reactive component of a circuit to the resistive component.

As applied to the tank circuit of an oscillator, the resistive component is that part of the impedance which dissipates power. Thus

$$\frac{L\omega}{r} = Q = \frac{EI}{P}$$

where  $E$  is the rms voltage impressed on the oscillating circuit,  $I$  is the rms value of current,  $P$  is the real power (heat losses plus power delivered to the load),  $L$  is the equivalent inductance, and  $r$  is the equivalent resistance which includes the resistance of the circuit components plus that resistance reflected from the load. In the type of oscillators we are describing it is found that this ratio should be 15 or 20 for stable operation. If the ratio is greater than necessary, excessive power is dissipated in the circuit components.

From the above relation between  $Q$ ,  $E$ , and  $P$  the apparent value of

Fig. 3—Approximate value of the constants for reasonably close coupling conditions, and with a one-turn two-inch loop as applicator

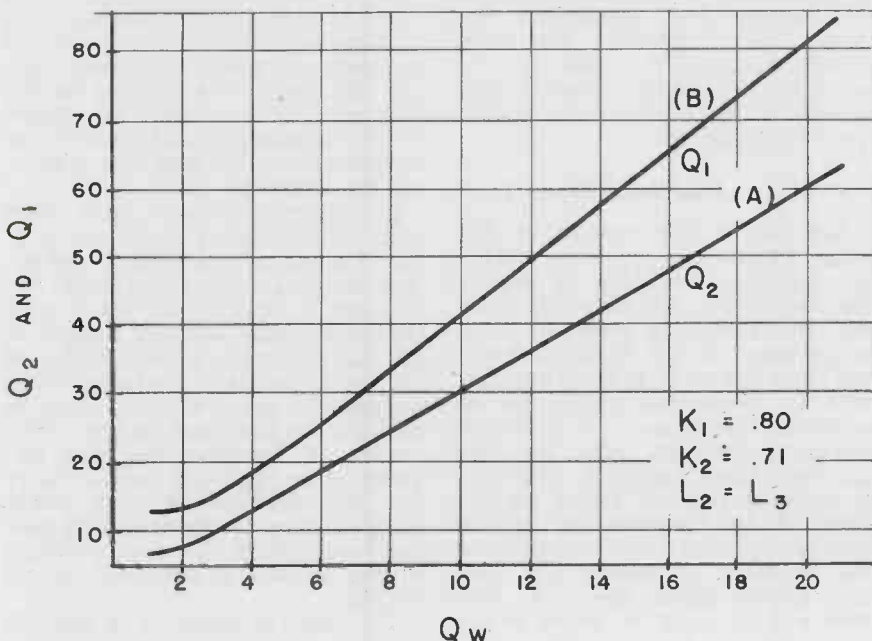

Q in the tank circuit depends upon how the circuit is "loaded." It is determined not only by the size and material of the tank circuit components, but upon the coefficient of coupling between the tank circuit and load, upon the nature of coupling links, and indeed upon the nature of the load itself.

**Coupling problems**

Moreover, the coupling problem in general resolves itself into adjusting the above factors in order to make the tank Q take a value of about 20. In the induction heating of most practical loads it is not hard to achieve this value for tank Q, but when the work to be heated has high electrical conductivity the problem becomes quite difficult.

Another interesting result of the above relation between power output and equivalent Q, can be shown as follows: Suppose for example that the rated power output of a certain tube is 50 kw at the rated plate voltage of 16 kilovolts. Further suppose that this tube is to be used in an induction heating equipment to operate at 400 kilocycles. When the plate efficiency is taken into consideration it is found that the rms voltage impressed on the tank circuit will be approximately 16 x .9 x .707 or 10 kilovolts. Assume the tank circuit to have a Q value of 20.

From the equation  $Q = \frac{EI}{P}$  the tank current

$$I = \frac{PQ}{E} = \frac{50 \times 1000 \times 20}{10 \times 1000} = 100$$

amperes.

Therefore, since the tank current and voltage are fixed, the impedances of the tank inductance and tank capacitor are also fixed at

$$Z = \frac{E}{I} = \frac{10,000}{100} \text{ or } 100 \text{ ohms.}$$

This impedance, together with the desired frequency (400 kc) fixes the value of tank inductance at

$$L = \frac{100}{2\pi \times .4 \times 10^6} \text{ or } 40 \text{ microhenries.}$$

Similarly the proper capacity

$$C = \frac{1}{100 \times 2\pi \times .4 \times 10^6} = .004 \text{ microfarads.}$$

If the same frequency is obtained by using a greater inductance and less capacity (keeping the coupled-in resistance constant), the circuit impedance will be too high and the tubes will not deliver the rated power at the rated voltage. On the other hand, if the inductance is too small and the capacity too large, the tube will be overloaded at its rated voltage.

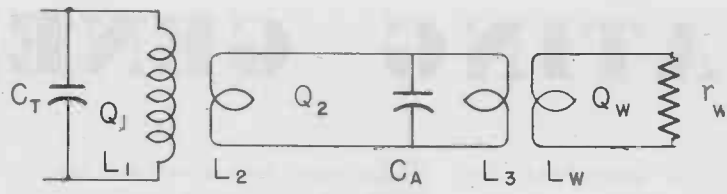

$$Q_2 = Q_w \left[ \left( \frac{1}{K_2^2} - 1 \right) \left( 1 - \frac{1}{m} \right) + \left( 1 - \frac{1}{m} \right)^2 \frac{1}{K_2^2} \frac{L_2}{L_3} \right] + \frac{1}{Q_w} \frac{L_2}{L_3} \frac{K_2^2}{(1 - K_2^2)^2} \dots \dots 3$$

$$Q_1 = \frac{Q_2^2 + 1}{K_1^2 Q_2 - Q_w \frac{K_1^2}{K_2^2} \left( 1 - K_2^2 \right) \left( 1 - \frac{1}{m} \right)} - Q_2 \dots \dots 4$$

Fig. 4—Schematic arrangement where it is desirable to use a capacitance in parallel with the applicator, the circuit being the same as shown in Fig. 2, except for capacitor CA

**Coupling Problems**

Perhaps the toughest problems in the whole design of industrial generators are to be found in the means of coupling the oscillator tank circuit to the load. If the work is a good conductor (such as a metal), energy can be coupled into it most effectively by an alternating magnetic flux. The changing flux is made to link through a section of the work and thereby to induce an electromotive force in it. Currents which flow as a result of the electromotive force (sometimes called eddy currents) develop the heat directly within the work. This process is called induction heating.

On the other hand, if the work is an electrical insulating material—a dielectric—power can be transferred from the oscillator to the work by means of a high frequency electric field. For dielectric heating the frequency is generally 10 megacycles or higher and the work to be heated is placed directly in the electric field established between two electrodes. The field strength is usually in the order of one kilovolt per inch. Heat is generated by dielectric losses within the work material.

**Low impedance load**

Because of the nature of the loads which are generally heated by induction the load is usually low impedance; for dielectric heating, the load is a relatively high impedance. In the dielectric heating the work to be heated, together with its electrodes, constitutes an electrical condenser. A resonant circuit is built up using the load as capacitance together with one or more sections of added inductance. As the frequency of the load circuit approaches the frequency of the oscillator, the desired high voltages appear across the load. The load circuit must be tuned either

by varying the added inductance or by varying the capacitance of variable condensers (included in the circuit for that purpose).

The load circuit is usually coupled to the oscillator by tapping across the tank inductance or by wrapping one or two turns as a secondary around the tank inductance.

At this point we encounter a problem which is still not completely solved. When the load has a low power factor and is loosely coupled to the tank circuit, it is difficult to load the oscillator sufficiently even when the load circuit is precisely tuned. On the other hand, if the load circuit is closely coupled to the tank, the familiar two-humped resonant condition appears. As the load is brought into resonance, the oscillator will suddenly skip and start oscillating at its conjugate frequency.

**Induction heating**

It has been found, however, that by coupling the load very closely to the tank and never completely tuning the load circuit, good conditions can often be obtained. There is still considerable disagreement as to just what is the best way of solving this problem.

A similar problem (and even more disagreement as to its solution) exists in the case of induction heating. Here the load impedance is usually low. If it is of the same order as that needed in the tank circuit, several turns of the tank inductance (those turns nearest the ground point) may be brought out and used as the applicator. If, however, the load impedance is relatively small, there are two alternatives: (1) either couple loosely to the tank and tune the load coil, or (2) couple closely to the tank and use little or no tuning.

For loose coupling it is possible



to tap the applicator leads across one or two turns of the tank inductance or to place a rather widely spaced secondary around it and connect the applicator to this secondary. Both of these methods are in wide use.

On the other hand, for close coupling between the high-impedance tank circuit and a low-impedance applicator the simplest arrangement\* is to use a broad single-turn secondary closely spaced about the tank inductance.

Here mechanical difficulties enter the picture; in order to have close spacing between primary and secondary, it is necessary to use some insulating medium besides air. The use of oil or compressed gas involves sealing problems. Semi-solid dielectrics have so far proved unsuitable and at present no method has been found which is electrically efficient, low in cost, and high in safety factor.

The close coupling system offers several advantages, one of which is that only a minimum of tuning is necessary. For many loads the applicator coil need have no added capacity. This of course is an ideal situation. It would be wonderful if an hf generator were built which would furnish its full rated power to any load which could be connected to it. In fact, it would be nice if one could use the 60-cycle power-line terminals in this fashion.

\*It is also possible to place the tuned load circuit in series with the tank inductance and get a fairly high degree of coupling but proper condensers for tuning small impedance loads are not available at present.

Just as the amount of low frequency or dc power which is delivered to a load is determined by the impedance of the load, just so the hf power taken by an induction heating load is determined by its electrical properties. The best the designer can do is to build an hf generator which will have low internal impedance so that the power which a load takes will be limited by the load and not by the internal impedance of the generator.

At present such a type of construction is very expensive and its use will have to await the lowering of costs and the development of new types of circuit components—especially of condensers.

In order better to understand the problem let us get down to circuit diagrams and formulas. For example, let us take the general coupling system diagrammed in Fig. 2. Here  $L_1$ ,  $C_T$  represents the oscillator tank circuit,  $L_w$ ,  $P_w$ , represents the work,  $L_2$  is the transformer secondary, and  $L_3$  is the applicator coil. The symbols  $L$ ,  $C$ , and  $P$ , as usual, represent the respective inductance, capacity, and resistance of the part in question. Let us also assume that the resistance of the various components of the coupling circuit is negligible compared to the equivalent resistance reflected into them from the work.

With these assumptions (and some laborious algebra) it can be shown that the  $Q$  of the link circuit is as shown in Eq. 1—Fig. 2, and that the equivalent  $Q$  in the tank circuit, in other words, the value of  $Q$  shown by the primary of output transformer when the ap-

plicator is loaded is as shown in Eq. 2—Fig. 2.

Approximate values of the constants, for reasonably close coupling conditions and with a one turn, two inch loop as applicator, are as follows:

$$K_1 = .80, K_2 = .71, L_3 = L_2.$$

Using these values of  $K_1$ ,  $K_2$ ,  $L_2$  and  $L_3$ , we may plot the value of  $Q_2$  vs.  $Q_w$ . This curve is shown as A in Fig. 3. From selected values on Curve A, a curve of  $Q_1$  vs.  $Q_w$  was plotted and it is shown as B in Fig. 3.

While it is possible to improve the coupling a little by careful design, yet  $Q_1$  will always be greater than  $Q_w$  and in most practical cases it will be greater by a factor of two or three. When the load is a steel cylinder which closely fits inside the above mentioned, two inch, applicator loop the value of  $Q_w$  is approximately 5. So, with the assumed coupling conditions, the tank  $Q$  takes a value of about 22. When the work is a good electrical conductor, however, its  $Q$  may be in the order of 20.\* Thus the equivalent of  $Q$  of the tank inductance may be in the order of 50 to 100.

### Tank design

It will be remembered that in the example of the 50-kw oscillator, previously cited, the  $Q_1$  of the circuit was taken as 20 and the impedance of the tank circuit was calculated with this figure, together with the power rating and plate-voltage rating of the tube. The question then arises, "If for certain loads the tank  $Q$  amounts to 50 or 100 why not design the tank circuit to have an impedance which is consistent with a  $Q$  of 50 or 100?" For an answer let us again return to the fundamental relation

$$P = \frac{EI}{Q} \quad \text{Note that } \frac{P}{E} \text{ is a constant}$$

whose value is fixed by the design of the power tube. Therefore, as  $Q$  increases, the value of circulating current in the tank must be increased in order that the desired power may be obtained. The upper limit of tank current is fixed by the current-carrying limits of the tank capacitor and by the permissible power losses in the circuit elements.

The cost of the tank condenser is one of the most expensive items in the generator. In present designs of oscillators the condenser cost is approximately equal to that of the power tubes and this cost increases about proportional to its current rating.

(Continued on page 202)

Fig. 5—Curves showing how the values of  $Q_2$  and  $Q_1$  vary with the impedance ratio of  $m$

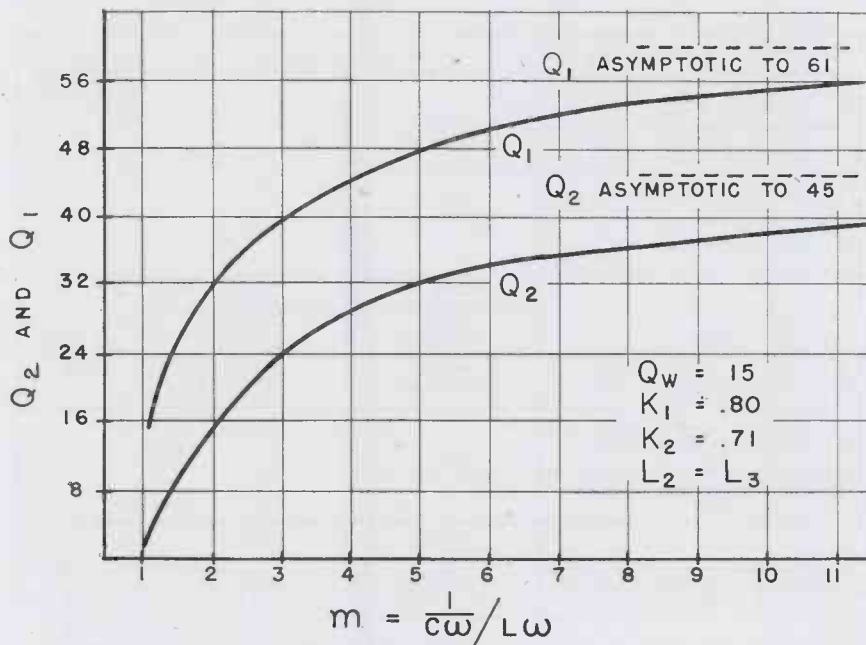

\*The values of  $Q$  are given for a frequency of about 400 kilocycles. However, the  $Q$  does not change rapidly with frequency.

# SURVEY of WIDE READING

Electronic news in the world's press. Review of engineering, scientific and industrial journals, here and abroad

## Insertion Loss of Dissipative Filters

D. G. Tucker (Wireless Engineer, London, February, 1945).

The paper gives some considerable extensions to a previous paper by C. W. Miller, Wireless Engineer, Jan. 1944, summarized in the March 1944 issue of Electronic Industries.

The formulas and curves applicable to high and low pass filter insertion losses are adapted for symmetrical band-pass filters by a simple substitution involving  $n$ , the ratio of bandwidth to mid-band frequency of the band-pass filter.

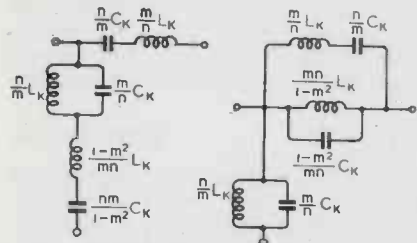

Fig. 1—Series-derived and shunt-derived band-pass half sections

Further, the effect on the insertion loss of dissipation in the coils is considered. The table gives approximate formulas at the frequency of peak attenuation, at the design cut-off frequency, and at the mid-band frequency for band-pass filters. The expressions given

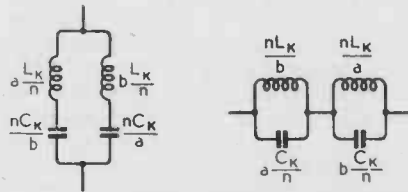

Fig. 2—Alternative series-derived shunt arm and shunt derived series arm in band-pass half-sections of Fig. 1

are not accurate for  $Q$  and  $Qn$  values below about 10. Exact expressions are included in the article as well as several graphs illustrating the corresponding behavior of the filters.

## Electron-Mirror Microscope

H. Mahl and A. Pendsich (Zeitschrift fuer technische Physik, Berlin, Vol. 1943, No. 2).

The projection lens in a conventional electron microscope is replaced by an electron mirror reflecting the electrons and eliminating the tubing length required by the second amplifying stage.

The structure of an electron mirror (Fig. 1) is identical with that of an electron lens. It is a system of three electrodes,  $a, b, c$ , the two electrodes  $a, b$  being at the same potential. If the potential of the center electrode  $c$  is slightly negative with respect to that of elec-

trodes  $a$  and  $b$ , the system behaves as a converging lens for electrons, ray 1 in Fig. 1.

## Electron mirror

For more negative potentials of the center electrode  $c$ , the axial component of the electron velocity is reduced to zero in front of the

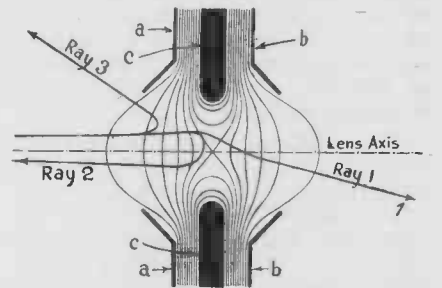

Fig. 1—Electron paths in converging lens, and converging and diverging mirrors

lens center. Consequently the electrons, which are accelerated by the field between electrodes  $a$  and  $c$  in a direction away from the lens center, do not traverse the lens but are reflected; the system behaves as an electron mirror.

The electrons penetrating almost to the center of the lens, ray 2, are deflected toward the lens axis on their return paths; the system cor-

(Continued on page 210)

WHOLE SECTIONS		INSERTION LOSS (expressed as a voltage ratio)	AT CUT-OFF FREQUENCY	AT PEAK FREQUENCY	AT MIDBAND FREQUENCY
Low- and high-pass	L.P. Series-derived $T$		$\sqrt{1 + \frac{1}{m^2} + \frac{2}{Qm} \left(2 + \frac{1}{m^2}\right)}$	$\frac{Qm}{(1 - m^2)^{3/2}}$	
	H.P. Shunt-derived $\pi$				
	L.P. Shunt-derived $\pi$				
	H.P. Series-derived $T$				
Band-pass	L.P. Series-derived $\pi$		$\sqrt{1 + m^2 + \frac{2}{Qm} \left(\frac{1}{m^2} + 2 - m^2\right)}$	$\frac{Q^2 m^2}{(1 - m^2)^{3/2}}$	
	H.P. Shunt-derived $T$				
Band-pass	L.P. Shunt-derived $T$		$\sqrt{1 + m^2 + \frac{2}{Qm} \left(2 + \frac{1}{m^2}\right)}$	as Fig. 1	as Fig. 2
	H.P. Series-derived $\pi$				
HALF SECTIONS	Low- and high-pass	Series-derived $T$	$\sqrt{1 + \frac{1}{m^2} + \frac{2}{mQn} \left(3 + \frac{2}{m^2}\right)}$	$\frac{mQn}{2(1 - m^2)^2}$	$\frac{Qn}{2(1 - m^2)^2}$
		Shunt-derived $\pi$			
	Band-pass	Series-derived $\pi$	$\sqrt{1 + m^2 + \frac{2}{mQn} \left(\frac{2}{m^2} + 4 - m^2\right)}$	$\frac{m^2 Q^2 n^2}{4(1 - m^2)^{3/2}}$	$\frac{m^2 Q^2 n^2}{4(1 - m^2)^{3/2}}$
		Shunt-derived $T$			
Low- and high-pass	L.P. Series-derived		$\sqrt{\frac{1 + 3m^2 + m^4 + (2/Q)(2/m + m^3)}{4m^2}}$	$\frac{Qm}{2(1 - m^2)}$	
	L.P. Shunt-derived				
Band-pass	L.P. Shunt-derived		$\sqrt{\frac{1 + 3m^2 + m^4 + (2/Q)(2/m + m)}{4m^2}}$	as Fig. 1	as Fig. 2
	H.P. Series-derived				
		Series-derived	$\sqrt{\frac{1 + 3m^2 + m^4 + (2/Qn)(4/m + m + m^3)}{4m^2}}$	$\frac{mQn}{4(1 - m^2)^{3/2}}$	$\frac{m + Qn}{Qn}$
		Shunt-derived			

$m = \sqrt{1 - (f_\infty/f_c)^2}$  for high pass,  $m = \sqrt{1 - (f_c/f_\infty)^2}$  for low pass, when  $f_\infty$  = frequency of infinite attenuation,  $f_c$  = cut-off frequency.

# Combining

1. SPECIAL PURPOSE ENGINEERING
2. RECEIVING TUBE TECHNIQUES

The 2C26A exemplifies Hytron's ability to build in soft glass, at high speed, and for economical prices, special purpose tubes. Hytron solved a tough problem for the Services by designing in the 2C26A a tube capable of performance and high ratings never before — or since — achieved in soft glass. This small tube — approximately the same size as the 50L6GT Bantam — is capable of delivering 2 KW of useful r.f. power at 200 megacycles. It replaces larger and much more expensive hard glass transmitting tubes which must be operated at much higher potentials.

## HYTRON TYPE 2C26A VERY-HIGH-FREQUENCY TRIODE PULSE OSCILLATOR

The Hytron type 2C26A is a special triode for use as a grid or plate pulse oscillator up to 300 megacycles. Its cathode is designed and processed to provide the extremely high peak plate currents required in pulse operation. Special top cap design permits use of the maximum potentials, without external voltage breakdown, at the higher altitudes. Other notable features are: convenient size, standard octal base, high-voltage internal ceramic insulators, and extremely rugged construction.



### ELECTRICAL

Coated Unipotential Cathode .....	6.3 volts
Heater Voltage .....	1.1 amps.
Heater Current .....	10 max. watts
Plate Dissipation .....	2.5 max. watts
Grid Dissipation .....	3500 max. peak volts
Plate Potential (plate pulsed) .....	2500 max. dc volts
Plate Potential (grid pulsed) .....	- 700 max. dc volts
Grid Bias .....	Eb:400V; Ec:-15V; Eh:6.3V
Average Characteristics for .....	16 ma.
Plate Current .....	16.3
Amplification Factor .....	2250 micromhos
Transconductance .....	
Average Direct Interelectrode Capacitances .....	2.8 mmf.
Grid-to-Plate .....	2.6 mmf.
Grid-to-Cathode .....	1.1 mmf.
Plate-to-Cathode .....	300 MC
Frequency for Maximum Rating .....	

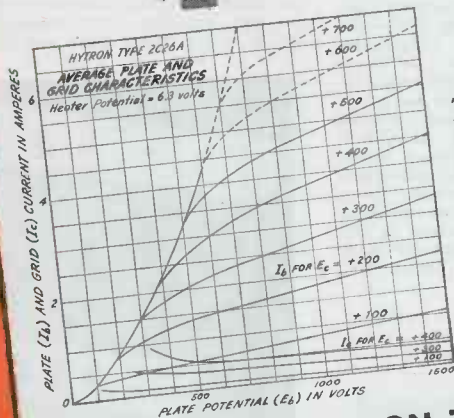

### MECHANICAL

Type of cooling .....	Convection
Base .....	Intermediate shell octal 8-pin phenolic
Top Caps .....	Skirted miniature with insulating bushing
Bulb .....	T-9
Maximum overall dimensions .....	3 11/16 inches
Length .....	3 3/8 inches
Seated Height .....	1 5/16 inches
Diameter .....	1 1/2 ounces
Net Weight .....	

**2C26A IS ON THE ARMY-NAVY PREFERRED LIST**

OLDEST EXCLUSIVE MANUFACTURER OF RADIO RECEIVING TUBES

# HYTRON

RADIO AND ELECTRONICS CORP.



MAIN OFFICE: SALEM, MASSACHUSETTS  
PLANTS: SALEM, NEWBURYPORT, BEVERLY & LAWRENCE

FORMERLY HYTRON CORPORATION

# WHAT'S NEW

Devices, products and materials the manufacturers offer

## Linear Actuators

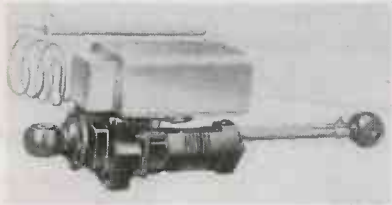

The new, light, Model "400" series of linear actuators, weighing as little as 3.05 lbs., are designed to operate under loads up to 400 lbs. of compression or tension. They require low power, 24-28 volts, and have extremely low current drain on the electrical system. In size, the "400" model is less than five inches wide, and less than seven inches long, including the limit switch control box and the thermal protector. The extension length ranges from 14% to almost 25 in. These actuators provide a complete package inasmuch as the unit takes electricity and provides the desired moving force without the need of additional accessories. Manufacturer is Lear, Inc., Piqua, Ohio.

## Heating Units



A number of forms of electrical heating units of which the one illustrated is typical have been developed by Landis & Gyr, Inc., 104 Fifth Ave., New York. All involve the use of woven type heating elements, this one being cylindrical for a width of one inch and fanning out to form a truncated cone covered by a metal spinning. In other instances units are furnished with Fiberglas covering or with bare resistance wire. Voltage may be 6 to 250 ac or dc at standard frequencies.

## Inspecting Ferrous Materials

Simple comparisons of ferrous materials as to analysis and heat-treatment are provided by the Ferrograph, a new metal-testing instrument developed by Allen B. DuMont Laboratories, Inc., Passaic, N. J. This instrument can be used to obtain quickly useful information about the characteristics of iron and steel. In the Ferrograph a 23-cycle exciting current is fed into the primary of a transformer whose secondary is controlled by the magnetic characteristics of a metal sample introduced into the field. The secondary voltage is filtered two ways: the fundamental 23-cycle wave is impressed on the horizontal axis and the third harmonic

on the vertical axis of a cathode ray tube. The first and third harmonics will vary in phase and amplitude with variations in the analysis and heat-treatment of steel or iron. Sorting of commonly used SAE steels is quite practical although in some cases the difference obtained is very small and may not be sufficient for sorting production lots of parts. About 80 per cent of the possible mixtures of two types of iron or steel can successfully be sorted. The low-frequency exciting current has an advantage over the use of 60-cycle in that the reversals of magnetizing flux are slow enough to give some appreciable effect from residual magnetism. A long-persistence screen is used in the cathode-ray tube to avoid flicker from the low frequency used. A relay turns the cathode-ray beam off automatically unless there is a sample in the test coil. The flux density in the test coil can be varied over wide limits.

## Paper-Dielectric Capacitors

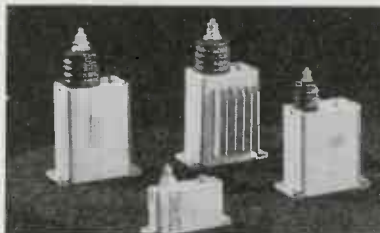

A new line of high-frequency paper-dielectric capacitors, available in ratings of 5,000 to 20,000 volts dc, 0.01 microfarad, has been added by the General Electric Co., Schenectady, N. Y., primarily for grid- and plate-blocking service in the electronic-oscillator circuits of high-frequency induction-heating equipments. The internal kraft-paper and aluminum-foil assemblies, compactly arranged and thoroughly impregnated with a low-loss liquid dielectric, are hermetically sealed in rectangular metallic cases. The size of the case cover and the over-all dimensions of the capacitor is reduced by use of a single insulated terminal, provided with a threaded terminal stud. For the other terminal, a stud is provided for connection to the case cover. The units are supplied with removable footed-type brackets, which provide for a firm four-point mounting in any position. The 20,000-volt rating is available in two designs—one in a plain case, and the other with cooling fins to permit a higher current-carrying capacity.

## Tool for Connectors

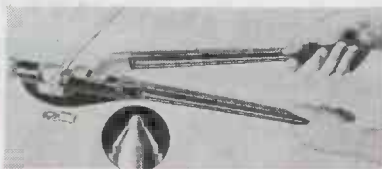

A husky, light-weight universal hand tool (MY28) for installing both copper and aluminum Hydent electrical connectors on large cables, has been introduced by Burndy Engineering Co., Inc., 107 Bruckner Boulevard, New York 54, N. Y. The tool is adaptable to more sizes and types of connectors than any other. It may be used on connectors for: aircraft cable, sizes No. 8

to 4/0, U. S. Navy cable, sizes No. 23 to 250 Mcm, commercial cable, sizes No. 8 to 250 Mcm, Flexible, Extra Flexible, and Welding cable, sizes No. 8 to 4/10. A single, stepped impression die makes the tool entirely self-contained. Adjustable holding die accommodates the entire range of connectors for which the Hytool is designed.

## 30-Watt Amplifier



Walker-Jimieson, 311 South Western Avenue, Chicago, have started production on a 30-watt amplifier, which operates on 110 volt, 60 cycle ac, with two mike inputs and one phono input and output impedances of 4, 6, 8, and 500 ohms. Frequency response is 50-10,000 cycles. The record gain is 69 db and the mike gain 116 db. Tubes employed are 3-6SJ7, 2-616, 6N7 and an 83. The amplifier is housed in a gray wrinkle finished steel cabinet 17 x 10 1/2 x 19 1/2 in.

## Ceramic Capacitors

Ceramic dielectric capacitors conforming to joint Army and Navy specifications JAN-C-20 are now in production quantities by the Micamold Radio Corp., 1087 Flushing Ave., Brooklyn 6, N. Y. They are available in preferred temperature coefficients for any capacity under designations CC20, CC25, CC30, CC35, CC40 and CC45.

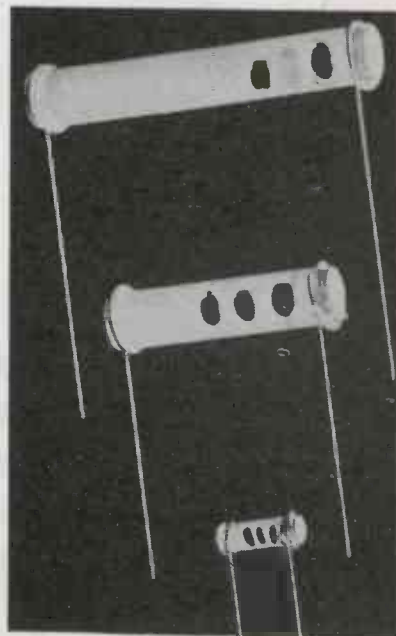

(See also page 118)

# PROBLEMS

## *in the UHF Field ?*



Your present or proposed product may demand precision in design, manufacture and performance. As specialists in the development of UHF equipment, we may be able to aid you in accomplishing this . . . at a lower cost. It's worth checking into. To help in the development of new products . . . or improve old ones, LAVOIE LABORATORIES offers this 3-point service:

1. **TECHNICAL ADVICE** by thoroughly experienced UHF engineers who know the "how" and "why".
2. **DESIGN** -- from the idea to the finished product, with a knack for practical, low-cost production.
3. **MANUFACTURE** of complete assemblies employing shop technique especially suited to UHF work.

Typical LAVOIE Products --



### UHF PRECISION FREQUENCY METER

Completely portable Accuracy 0.1%  
Battery or AC-Operated

Models available from 100 to 2000 megacycles with 2 to 1 frequency coverage on each model.

#### RECOMMENDED FOR:

- Production testing
- Measurement of oscillator drift
- Independent alignment of transmitters and receivers
- Precise measurements of frequencies



### UHF HARMONIC FREQUENCY GENERATOR

PROVIDES output voltages which are multiples of 10 or 40 megacycles with CRYSTAL-CONTROLLED accuracy.

SELECTS 10 or 40 megacycle series and IDENTIFIES one of these harmonics by means of a Frequency Identifier which consists of a filter providing high attenuation of all voltages except that of frequency to be identified.

USED FOR calibration of receivers, wave-meters, or using internal beat detector, for calibration of oscillators and signal generators.

RADIO ENGINEERS AND MANUFACTURERS  
MORGANVILLE, N. J.

## *Lavoie Laboratories*

**Specialists in The Development of UHF Equipment  
and in The Manufacture of UHF Antennas**

# WASHINGTON

★ ★ ★ ★ Latest Electronic News Developments Summarized ★ ★ ★ ★  
by Electronic Industries' Washington Bureau

**SETS WITHIN A YEAR**—Army and Navy requirements have loaded up radio-electronic industry to capacity up to the fall and possibly for rest of 1945. WPB Chairman Krug stated unequivocally that civilian home sets will be launched in volume production within a year after V-E Day. Set production may come sooner after V-E, within nine months, probably in fairly small flow. All depends on the imponderable "ifs."

**FIRST, NON-BROADCAST EQUIPMENT**—In line with WPB's policy to give the right-of-way to civilian equipment needed by essential civilian services, including communications, WPB's Radio and Radar Division is allowing increased production of civilian point-to-point communications, aviation and emergency apparatus while still holding down the lid on broadcasting equipment. First relaxation in broadcasting apparatus will probably be in transmitters.

**AVIATION RADIO EQUIPMENT**—Aviation equipment, as soon as the determinations of what postwar system to be used by the domestic and international airlines has been made by the Radio Technical Commission for Aeronautics, will be started in civilian production in substantial volume, while the radio-electronic needs of passenger airplanes now being relinquished by the military services are being authorized at present by WPB. The procedure for the approval of international point-to-point and domestic coastal, mobile and relay equipment, together with authorization machinery for emergency apparatus—police, fire, forestry and utilities services—also has already been set in operation. **Reiterated emphasis**—until the war production major job is finished, civilian manufacturing has to be confined to those fields where apparatus runs into thousands as contrasted with broadcast-FM-television sets numbering in the millions.

**TELEVISION TO PLAY MAJOR ROLE**—Top reconversion officials in Washington—retired War Mobilization Director Byrnes and WPB Chairman Krug—view FM and television, particularly the latter, as among the new postwar industries which will play a major role in employment. Therefore the industry may be certain that every effort to implement radio's reconversion will be consummated. Captain Jennings B. Dow, able Director of Electronics for the Navy, brought out in a recent statement to **ELECTRONIC INDUSTRIES** that "the developments and uses of television in the future, which can be seen now only dimly, will certainly exercise a profound influence over the life of the nation in peace, and if necessary in war."

**CONTINUE TELEVISION RESEARCH**—Captain Dow declared that at the end of the war "television will emerge finally as a reality for use and entertainment of our people" and, besides being a most significant medium of entertainment, "will spread into many fields of usefulness." Because of the potentialities of television for military uses, the Navy Electronics Director has advocated that continued and concentrated research in this field of electronics occur after peace comes.

**V-E DAY AND IMPACT ON EQUIPMENT PRODUCTION**—Army Signal Corps (together with Air Forces in regard to airborne radio-electronic apparatus) will probably institute cutbacks of between 10 and 15 per cent in the first three months; and then will increase terminations of production up to about 40 per cent in a year after European victory.

**NAVY PRODUCTION TO CONTINUE**—The Navy, because of the needs of the Pacific fighting, is planning an even level of about \$67,000,000 a month in deliveries for some time to come. Signal Corps in order to cushion the reconversion impact as far as possible is trying to study the cutback effects on the basis of case-by-case studies of companies. Tropicalization of European equipment may be needed on apparatus sent back from France and Germany to the Pacific, but in more complicated equipments tropicalizing treatment is often too difficult and expensive so it is just as economical to produce new apparatus. Then, too, there is the factor of how much Army equipment has to be left with the occupation forces.

**FCC ALLOCATIONS**—The goal of completing its final spectrum allocations above 25,000 kc and the proposed plan for the frequencies from 10 to 25,000 kc had been scheduled by the FCC in the latter part of April. If this objective was not achieved, the allocations determination was certain to be issued in early May.

**SEE FM GOING "UPSTAIRS"**—Highlight point of FCC allocations was assured decision to move FM broadcasting from its present bands "upstairs." Commission's Engineering Department, meanwhile, has been consulting with industry—and using findings and material of RTPB's studies—on the promulgation of new standards of engineering for all radio services after the war, not only revised standards for AM broadcasting but for FM and television and facsimile and all non-broadcast services. It is not expected that hearings will be necessary but will be joint FCC-industry effort. Television financing, operation and program plans will be subject of FCC inquiry later after allocations are determined with objectives of each prospective television broadcaster examined.

**PRICES TO BE HIGHER BY 30%**—Interesting survey by U. S. Commerce Department forecasts postwar annual volume of receiver sales (compared with \$460 million in 1941) at \$1,410,000,000 194VE plus 1; \$1,650,000,000 for next year; \$1,870,000,000 for third year; and \$1,430,000,000 for fourth year. Because of increased costs of labor and materials, a 30 per cent rise in set prices in 194VE plus 1 is forecast. FM on a short time basis will be more important than television, the Commerce Department predicts. FM Broadcasters Inc. also had a forecast of \$2,000,000,000 sales in the first postwar year of transmitters and receivers; and 350 new stations—for five years \$10,000,000,000 aggregate sales of equipment and 2500 stations.

National Press Building  
Washington, D. C.

ROLAND C. DAVIES  
Washington Editor

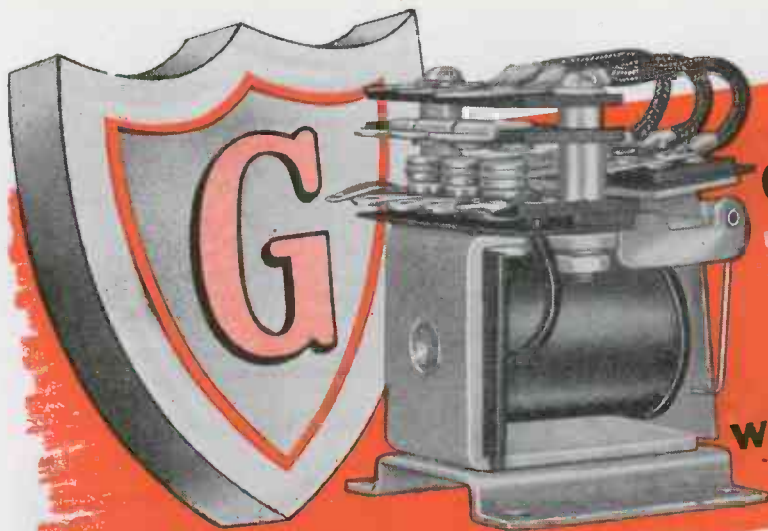

# GUARDIAN Series 345 RELAY

a "Basic Design"  
with many variations

*meets special applications*  
saves time . . . saves tooling . . . speeds delivery!

If your application requires a specially designed relay Guardian engineers can be of great help to you. But, as a result of their wide experience in designing "specials" they have evolved a standard design so flexible that it is now specified in numerous applications that would ordinarily require a specially designed unit. Perhaps you can use it in your "special" application . . . with a saving in money and delivery time. This unusually flexible relay is the SERIES 345. Its chief features are the large coil winding area, numerous contact combinations, the non-binding pin type armature hinge pin, its resistance to shock and vibration, and an ability to operate in extremes of temperature. It is now being used in aircraft, radio, and other exact-

ing applications to insure dependable performance.  
**STANDARD SERIES 345**—The ample coil winding area of the SERIES 345 gives you a wide range of windings for various voltages and currents. Coil winding area is approximately .75 cubic inches. Average power required is 3.56 watts with three pole, double throw contacts of 12½ amp. capacity. Coils are available for either A.C. or D.C. operation.  
The maximum switch capacity of the Standard Series 345 is three pole, double throw. Contacts are rated at 12½ amperes at 110 volts, 60 cycles, non-inductive A.C. Moving contacts are attached to but insulated from the armature by a bakelite plate. Terminals are solder lugs. Weight is 6½ ounces.

## VARIATIONS OF THE SERIES 345 RELAY

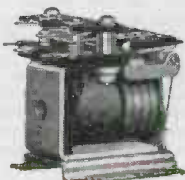

**TIME DELAY**

**WINDING**—Multi-wound coils are available for operation on two or more circuits. Or coil may be wound to operate on the discharge of a 3 mfd. condenser.

**CONTACTS**—Normal switch capacity is three pole, double throw; maximum switch capacity may be up to six pole double throw with 12½ amp. contacts, or any vari-

ation of contact combinations within this range, including the operation of contacts in sequence. The flexibility of the contact springs may be increased through the use of coil spring rivets.

**TIME DELAY**—On D.C. coils a time delay of 0.25 seconds on release or 0.06 second on attract may be achieved through the use of copper slugs which require these time intervals for saturation or de-energizing depending on whether they are used on the heel or head of the coil.

**DUST COVER**—For applications where this relay may be subject to injury or in atmosphere where dust may be present in sufficient quantity to impede operation, the SERIES 345 may be equipped with a metal dustproof cover.

**SCREW TERMINALS**—Screw type terminals are optional for applications where terminals must be disconnected occa-

sionally or where solder lug terminals are not otherwise practical.

**INTERLOCKING:** Here the series 340 a-c relay is coupled with the d-c coil of a series 405 short telephone type relay in an overload application. Under normal conditions the series 340 contacts are mechanically held in a closed position. Normal

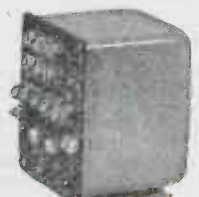

**DUST COVER**

current flows through the series 405 coil and then through the series 340 contacts to the circuit for which overload protection is desired. Excessive current, however, energizes the series 405 coil, releasing the locking arrangement and breaking the series 340 contacts. Push button control resets to normal but is ineffective if current is still excessive.



**INTERLOCKING UNIT**

### SERIES 345 RELAY DATA

Normal Volts	Minimum Volts	Normal M.A.	Minimum M.A.	Coil Resist.	Normal Wattage
6	4.8	600	480	10	3.56
12	9.8	300	245	40	3.56
24	18	148	111	162	3.56
32	25.6	112	89	287	3.56
115	92	31	25	3720	3.56

Minimum operating wattage.....2.3

*If you will write us about your relay problems our engineers will be glad to make recommendations which may save you time and money. Should you desire a quotation, please mention quantity.*

**GUARDIAN ELECTRIC**  
1622-F W. WALNUT STREET CHICAGO 12, ILLINOIS  
A COMPLETE LINE OF RELAYS SERVING AMERICAN WAR INDUSTRY

## Portable Oscilloscope

A new portable oscilloscope, Type CRO-3A, has been developed by the Specialty Division of the General Electric Electronics Department, Schenectady, N. Y. Was built for accurate and rapid maintenance work, is especially designed for industrial and radio uses. This unit is equipped with a 906-P1 cathode-ray tube which has a



greenish screen that can be viewed in daylight. A special design removes the ac ripple from the ac transformer field and gives a sharper and more clearly defined signal picture. Moderately high-speed traces can also be photographed on this screen. The unit has a wide range sweep circuit featuring a linear amplifier. Sweep rates from 10 to 30,000 per second are adjustable by a 7-point vernier switch.

## Signal Relay

Weighing only 1 1/4 oz., the R-B-M Type 23,000 signal and communication relay designed by R-B-M Mfg. Co., division of Essex Wire Corp., Logansport, Ind., has 6 normal-

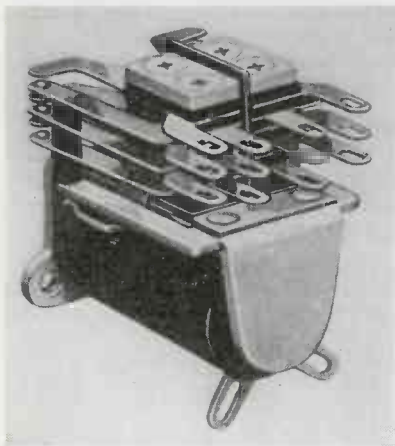

ly open contacts; contact rating, 3 amps. dc non-inductive and is available in other arrangements of normally open and normally closed contacts. Vibration resistance up to 10 g's at 40,000 feet; temperature ranges, -65° C. to +85° C.; approximate dimensions, 2 1/4 in. long, 1 1/2 in. high, 7/8 in. wide. Magnet coil bobbin is high-impact, specially molded phenolic material of high insulating value, resistant to electrolysis, and capable of withstanding severe humidity. This type of relay is also available with heavy duty contacts rated at 10 amps, 28 volts dc non-inductive.

## Thermostat Switch

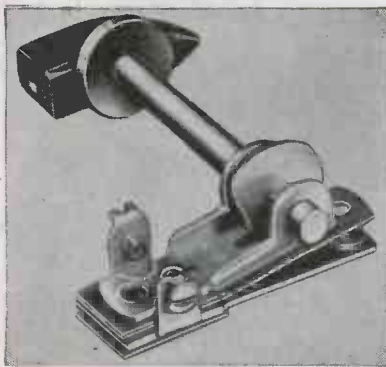

This is a combination cam-adjusted thermostat and manually-operated switch. The temperature at which the thermostat operates is adjusted from the panel knob which also provides for opening the switch. The unit is available to operate in three ranges: 50-300 F; 50-450 F; 50-700 F, the rating being 1,500 watts at 115-230 volts ac. The manufacturer is George Elanet Co., 88 East Kinney St., Newark, N. J.

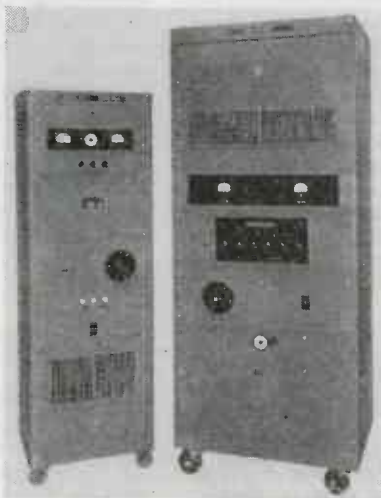

## Life-Test Equipment

Green Electric, 130 Cedar Street, New York, has completed a life-test unit for electronic tubes, comprising two complementary units, the plate supply rectifier, and the life-test cabinet. Up to 1 1/4 amperes at potentials up to 2,000 volts for plate supply to the tubes under test are provided by the plate rectifier, which is three-phase operated and built to include a filter, continuously variable voltage control, time delay relay, door interlock safety switches, supervisory lamps, voltmeter, ammeter and interlock circuits for connection to the life-test cabinet. A detail is the running-time meter which indicates the duration of the life-test. The life-test cabinet accommodates six triodes with total plate dissipation of over 2 kw. The life-test unit incorporates continuously variable filament supply, a filament voltmeter, regulated grid supply, plate ammeter, circuit breaker, supervisory lamps, door safety switches and interlock circuits associated with the plate supply rectifier. The interlock circuits which cut off plate supply if the grid bias fails, or if the access doors are opened, are an important safety measure. Featured are means for independent control of the grid bias on each tube under test, and provision for independent plate current measurement of each tube under test. Since filament voltage, grid-bias voltage and the plate supply voltage are all variable, it is possible to adapt the unit for testing other types of tubes simply by changing the tube sockets.

## High-Vacuum Rectifier

A new, high-vacuum, half-wave rectifier tube has been put into production by Taylor Tubes, Inc., 2312 Wabansia Avenue, Chicago. The tube bears the number TR-40M and is 9 1/2 in. high with a maximum diameter of 3 13/32 in. It is equipped with a 4-pin jumbo (50-watt) base and the glass is Nonex. The filament is thoriated tungsten. Plate lead is at the top, and filament leads are brought out to pins Nos. 2 and 4. Electrical characteristics; filament power—5.0 volts at 10.5 amperes; peak forward volts—25,000; peak inverse volts—60,000; average plate current—.25 amperes.

## Pressure Indicator



Electro Products Laboratories, Inc., 549 West Randolph Street, Chicago 6, has a new linear pressure-time-curve indicator. The device will indicate, in linear response on the screen of a cathode ray oscillograph, the pressure-time curve of any internal combustion engine, pump, airline, or any other enclosed pressure system where pressure measurements are desired. The Pressure-graph measures either static or dynamic pressures. In operation, the pickup section of the Pressuregraph is inserted in the cylinder, chamber or airline, etc., to be pressure measured. The pickup response is transmitted, after amplification, to the screen of a cathode ray oscillograph.

## Switch Copper

A specially prepared switch copper that eliminates hand-finishing of the metal before assembly and effects a great reduction in the rejections of the finished product has been developed by Revere Copper and Brass, Inc., 230 Park Avenue, New York 17, N. Y. The new copper has a superior polish which means lower losses at contact points of switches, knife blade fuses and exposed bus bars. The new metal has close tolerances that include no convexity when flatness is measured across the width of the bar; concavity .001 in. maximum per side up to 2 in.; .002 in. per side, 2 in. and over; camber, or depth of lengthwise arc, 1/8 in. maximum in 8 ft. It comes in square or rounded edges.

## Inductance Connector



An ingenious type of tank circuit inductance connector has been developed by Monitor Controller Co., Lombard and Frederick Sts., Baltimore, Md. It is made of hard brass in two sizes for helix strips of 3/16th and 1/4-in. width and thicknesses from 1/16th to 3/32d in. It provides a three-point contact, is fastened with a single screw and nickel plated for corrosion resistance.

(See also page 136)



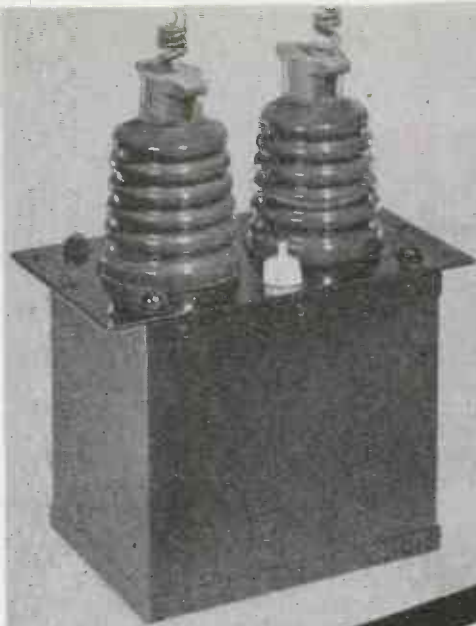

# TRANSFORMERS *of Special Design*



A few of the many high quality transformers manufactured to critical specification. Rigid control of material and process—PLUS conservatism in design insure a dependable long-life product. We solicit your inquiries. Sizes to 5 KVA.



## The Langevin Company

INCORPORATED

SOUND REINFORCEMENT AND REPRODUCTION ENGINEERING

NEW YORK

SAN FRANCISCO

LOS ANGELES

[www.americanradiohistory.com](http://www.americanradiohistory.com)

1006 N. Seward St. 38

# ★ TELEVISION TODAY\* ★

## New Developments in the Video Field

### Predicts Wide Field For Television in War

Television, however thrilling and satisfactory as a medium of entertainment, will spread into many new fields of usefulness, predicts Captain Jennings B. Dow, Director of Electronics for the Bureau of Ships, who believes that "the developments and uses of television in the future, which can be seen now only dimly, will certainly exercise a profound influence over the life of the nation in peace, and if necessary in war. It is conceivable," he adds, "from our present knowledge of the possibilities of television, that equipment will be developed which will alter the strategy and tactics of land, sea, and air battles of the future; equipment of such significant potentialities that no military or naval command can fail to carefully weigh its offensive and defensive value."

### International Standards Conference in London

Representatives of Television Broadcasters Association have been invited by the British Institution of Radio Engineers to attend a conference on international television standards scheduled to be held in London this month. The invitation was extended by Paul Adorjan, a director of Rediffusion, Ltd., of London.

### 112 Tele Applications

Applications for the establishment of commercial television transmitters continue to pile up at the Federal Communications Commission. At present there are 112 applications pending, representing applicants in 31 states and the District of Columbia. Many additional applications are pending for experimental television transmitters and video relay stations.

### Portable Record Player

Manufacturers are investigating U. S. production costs of a portable record player with combination spring-and-electric motor (110 v. ac) which has been shown in an Eastern city. Ideal for beach and vacation use, they see a good market for it at around \$40. The original Swiss product is also made with

two tubes for amplification, although the purely mechanical pick-up model exhibited performs with good volume and quality.

### Facsimile Today

Talking before the recent National Association of Broadcasters convention, John V. L. Hogan gave a comprehensive picture of the state of the facsimile art as it exists today. He said:

"It has been nearly eleven years since I spoke before the Hot Springs convention of the National Association of Broadcasters on the subject of visual broadcasting, which is the broad term covering both television and facsimile. At that time I urged broadcasters to investigate both television and facsimile, in spite of the fact that neither of them was then very 'hot,' and to take a leading part in the development rather than allowing them to grow up as services competing with sound broadcasting.

"At that time—1933—which was

the year before we had FM, facsimile was limited to the transmission of about 3 square inches of picture or about 60 words of text each minute. That was too slow to provide a really good service, but by the time of Pearl Harbor the speed had been increased to about 10 square inches of pictures, or approximately 200 words of text per minute.

"Why should broadcasters now become interested in facsimile? Because it has now truly become what it was earlier called, the 'home printing press' or the 'magic typewriter,' a machine that can set down on paper by radio control any size or face of type and any sort of chart or picture.

"It leaves a record in the home. It can deliver a printed magazine instantly and simultaneously to every radio home. Its technics have advanced so far that it can now deliver a 48 sq. in.—that is to say, a 6 x 8 in. picture—or about 1,000 words of text every minute. That

(Continued on page 218)

## TELEVISION COLOR CHART DEVELOPED BY RKO



One of the chief problems that has presented itself in the production of Television programs has been the selection of proper colors for broadcasting. Reds, greens, blues, and yellows look one way to the eye in the studio and another way over the iconoscope. In an endeavor to assist in solving this problem, the RKO Television Corp. has devised a color chart which it has installed in the DuMont television studio. By viewing this chart on his monitor screen a director is able to see at a glance which colors will give a contrasting or blending effect on the home television receiver

\*Title registered U. S. Patent Office.

Wherever You Need CONSTANT D. C. VOLTAGE OUTPUT . . . . Put In a  
**HARVEY REGULATED POWER SUPPLY 106 PA**

• 140 MA. at 200-300 volts with  
1% regulation.

Output remains constant within  
1% even though line voltage  
varies between 95-150 volts.

Two separate filament voltages  
are available: 6.3 volts, 5 amps.  
each. Easily accessible from rear.

Exclusive: Windings are phased  
and so designed that parallel  
operation is possible if desired.  
This 6.3 volts at 10 amps. is  
available.

Ripple content is better than 10  
MV. The advantage of this is  
apparent upon reflection that the  
usual specification is 1/10 of 1%.  
That really means 500 MV.

Write for HARVEY 106 PA  
bulletin today.

**HARVEY**

OF CAMBRIDGE

**HARVEY RADIO LABORATORIES, INC.**

441 CONCORD AVENUE • CAMBRIDGE 38, MASSACHUSETTS

# ASSOCIATION NEWS

*Happenings of the month concerning industry organizations*

## **Wire Recorder Standards**

Standardization of the design and construction of wire recording equipment is on the cards. Early in April the 15 manufacturers at present operating under license from the Armour Research Foundation of the Illinois Institute of Technology gathered at the plant of the Stromberg Carlson company in Rochester to go into the whole subject. The plan is to arrange so that wires recorded on one make of machine may be played back on another. Manufacturers of the equipment see considerable possibilities for its use as a business machine and for other similar purposes for which other types of recording mechanisms are used. Latest developments include the design of a smaller, lighter model capable of holding 11,500 ft. of 0.004 carbon steel wire upon which a total of 66 minutes of dictation or other recording can be made; another is the development of a 0.003 stainless steel wire which doubles the recording capacity of older, larger wire.

## **FM Discussion**

The discussion of the position of FM in the radio spectrum, which took place on January 27, at a special session of the four-day IRE Winter Technical meeting terminating on that date, has been transcribed and, as a result of the many requests for the information, additional copies of the transcription were made by the Institute of Radio Engineers for general distribution. The transcription, containing thirty mimeographed pages and bound in a durable cover, is available at three dollars a copy, postage prepaid, and requests for it should be addressed to the IRE at 330 West 42nd Street, New York 18, New York.

## **Sound Quieting**

To determine the effect of sound quieting on workers and production, Colgate University has assigned two of its psychologists, Dr. F. Kenneth Berrien and Clarence W. Young, to conduct extensive surveys in manufacturing establishments in six eastern states. Initial results of the survey, which is being sponsored by the Acoustical Ma-

terials Association, will be reported about Sept. 1. E. M. Fuller, chairman of the A.M.A. Research Committee, said that special effort will be made to determine the effects of noise reduction on health, accidents, speed and quality of output, absenteeism, employe turnover and general morale.

In addition to studying records, interviewing workers and giving morale questionnaires in various industrial plants, before and after sound reduction is introduced, the Colgate professors will conduct studies in a specially equipped laboratory at the university. There they expect to determine the kinds of factory noise for which acoustical treatment gives the greatest benefits and the levels at which such treatment is most effective.

## **Conventions and Meetings Ahead**

**Society of Motion Picture Engineers** (J. Haber, Hotel Pennsylvania, New York); May 14-18, Hollywood-Roosevelt Hotel, Hollywood, Cal.

**Society for Experimental Stress Analysis** (W. M. Murray, President, Central Square Station, Cambridge 39, Mass., Post Office Box 168); 1945 Spring Meeting, May, Buffalo, N. Y.

**American Society for Measurement and Control** (L. Susany, c/o Carnegie Institute, 4400 Forbes Street, Pittsburgh); "Instrumentation for Tomorrow" Exhibit and Conference, September 17-21, William Penn Hotel, Pittsburgh.

**American Society for Measurement and Control** (L. Susany, c/o Carnegie Institute, 4400 Forbes Street, Pittsburgh); "Instrumentation for Tomorrow" Exhibit and Conference, September 17-21, William Penn Hotel, Pittsburgh.

In conformity with government regulations, many organizations have cancelled scheduled gatherings; others have requested permission to go ahead but have not had definite instructions. In view of these facts it would be well for those who contemplate attending meetings to check first with the organization before arranging transportation.

## **Precision Measurements**

Ohmite Mfg. Co. has made a grant of \$15,000 to the Illinois Institute of Technology to be used for the establishment of a laboratory for the precision measurement of electrical and magnetic quantities. It represents the initial contribution for equipping what will be known as the Ohmite laboratory for precision measurements. The ultimate object of the laboratory is to provide precision electrical measurements for the Chicago area approaching in accuracy those of the Bureau of Standards in Washington.

## **RMA Talks Production**

Late in April (25-26) directors and officials of the Radio Manufacturers Association and its Canadian affiliate met in Montreal to give mutual war program problems a general going-over. Suggestions for future postwar cooperation between the two organizations came in for considerable discussion. The main part of the program had to do with the promotion of radio-radar equipment production.

## **RMA Parts Code**

Radio Manufacturers Association has at present under consideration a code system to help in the identification of the manufacturing source and date of production of radio parts. The plan is to identify such parts with numerals or a combination of numerals and code letters which will indicate the month and year of production as well as the manufacturer.

## **Joyce Will Produce Films, Visual Aids**

Thomas F. Joyce, who recently severed connections with the RCA Victor Division of Radio Corp. of America, after more than two decades of service, has formed the Conners-Joyce Co., for the production of technical manuals, training films and visual aids. Ray R. Conners, Jr., is the other member of the firm. Offices have been established in Los Angeles, in New York at 18 East 41st Street in charge of Rene G. Varlay, and in Chicago in charge of Raymond Lee.

# CONTACT!

Behind bombing missions and dog fights

at every one of our invasion points

you'll find Super-Pro receivers

on twenty-four hour duty with the AACs

under almost impossible

operating conditions.

CRYSTAL  
SELECTIVITY

BAND  
WIDTH

LIMITER  
ON

MAIN  
TUNING

MANUAL

AVC

SUPER-PRO

HAMMARLUND MFG. CO. INC.



ESTABLISHED 1910

THE HAMMARLUND MFG. CO., INC., 460 W. 34<sup>TH</sup> ST., N.Y.C.  
MANUFACTURERS OF PRECISION COMMUNICATIONS EQUIPMENT

**HOW EXCELLENCE IS BUILT INTO**

# Sangamo

**MICA  
CAPACITORS**



\* The above picture shows a group of operators assembling by hand the mica films and foil used in the manufacture of capacitors of small capacitance values. Special assembly fixtures are used to insure accurate positioning of component parts.

**SANGAMO ELECTRIC**

ESTABLISHED 1898 . . . MICA CAPACITORS . . .



★ This operator is assembling mica and metal foils to form a unit which constitutes the essential element of a mica capacitor. Hand operators are utilized where only a few sheets of mica and foil are required for units of low capacitance value. Specially trained operators insure proper placing of component parts, resulting in a finished product of high quality.



## Hand Stacking

Capacitors utilizing mica as a dielectric are manufactured in a complete range of sizes from very tiny wire lead units having capacitance values of as low as 5 mmfd. to large ceramic housed units having capacities which may be as high as several microfarads. Voltage ranges, too, vary from small units having dielectric strength test of only 300 volts or less, to those units built to withstand 40,000 or 50,000 volts or more.

In the manufacture of the large units, the stacking of the mica element is performed by special machines designed for that purpose. In the manufacture of the very small units with low capacitance values, plates are sometimes utilized and it is, consequently, impractical to stack these with automatic equipment. In these cases, hand operators are utilized who become very skillful in stacking the alternate layers of foil and mica, and in keeping the exact alignment so necessary for the production of a good capacitor.

Where special characteristics are required a silver deposit is sometimes placed on the mica and fired on, and thus becomes the conducting plate in the capacitor assembly. By firing silver on mica, very intimate contact is made with the dielectric, and as a consequence, stability, that is, capacitance drift, is improved and special temperature characteristics obtained. It is essential that the silver coating be of uniform texture, with clean, well defined edges, so as to prevent excessive corona and ultimate voltage breakdown of the capacitor unit. Sangam builds many thousands of the silver mica capacitors each day and is well equipped to produce and test these units in accordance with the required characteristics.



**COMPANY** SPRINGFIELD ILLINOIS

• • WATT HOUR METERS • • • TIME SWITCHES • • •

# NEW PATENTS ISSUED

## Reducing Input Conductance at HF

In the megacycle range the input conductance plays an important and detrimental part in the performance of a tube. It is therefore intended to reduce the input conductance and to make it independent of control grid voltage and of frequency.

The special electron tube shown contains two different discharge paths (designated sections A and B) connected in parallel so that the input conductance of the complete structure is equal to the sum of the two individual conductances. Section B is a conventional triode, its input conductance is positive, see top curve.

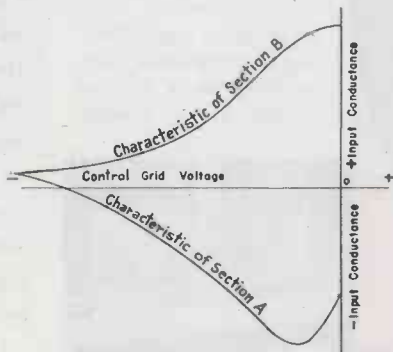

The essential requirements for a negative input conductance is a control electrode slightly negative with respect to its associated cathode and interposed between two electrodes of positive potential. Section A meets these requirements, its space charge

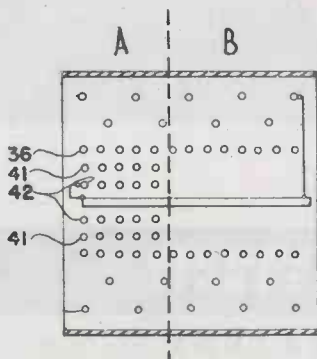
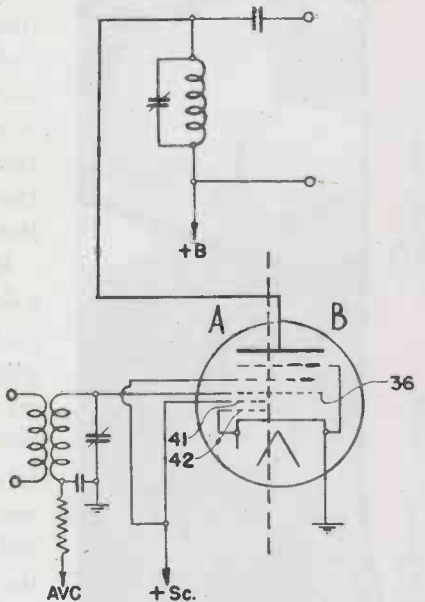

grid 41 causes the formation of a virtual cathode between control grid 36 and cathode and adjacent the control grid, resulting in a negative conductance. Auxiliary electrode 42 reduces the amount of current which would otherwise be drawn by the space charge electrode 41.

The spacing of the electrodes and their normal operating potentials are so proportioned that the positive and negative conductances of the two sections are complementary over the operating range of the stage; their sum, a comparatively small constant value, will be the effective input conductance of the complete structure. The negative input conductance of section A was found to vary somewhere between the 1.5 and 2.0 power of the operating frequency, which is about the same as that of section B. Consequently, the combined characteristic will be substantially independent of frequency as well as of control voltage.

Different arrangements of the two additional grids are shown. The two electron paths constituting the two sections may be contained in separate tubes.

R. L. Freeman, Hazeltine Corp., (F) January 30, 1940, (I) December 12, 1944, Re. 22,576.

## Push-Pull Circuit

A single-tube driver stage is coupled to a push-pull stage without the use of a transformer or an additional phase-inverter tube. The 180 deg. out of phase voltage

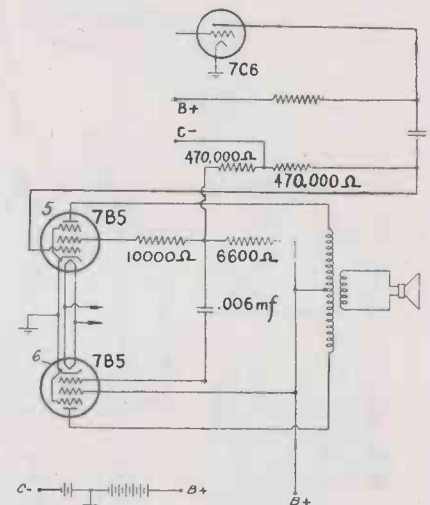

for the input of the second tube 6 is derived from the screen grid of the first tube 5.

Because of the control-grid-to-screen-grid transconductance of tube 5, signal current 180 deg. out of phase with the control grid voltage, will flow in the screen grid circuit. A corresponding signal voltage will be developed across the 10,000 ohms resistor connected to the screen grid of tube 5 and be applied to the control grid of tube 6. By proper dimensioning of the circuit components, the voltage supplied to the grid of tube 6 is made substantially equal to the input voltage of tube 5; if different types of tubes are used, the voltage may be accordingly selected to give satisfactory push-pull operation.

W. E. Gilbert, Philco Radio and Television Corp., (F) November 13, 1941, (I) October 24, 1944, No. 2,361,282.

## Diversity Receiving System

The phases of the received energies at the different antennas of a diversity receiving system do not remain constant but vary relative to one another with fading. This variation in the relative phase introduces distortion; for instance the energies will cancel out when the carriers received on two or more antennas are of opposite phase

# KEEP OFF THE

# Beam

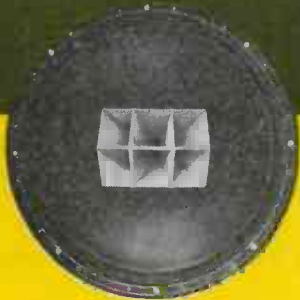

## WITH THE DUPLEX SPEAKER

The very objectionable concentrated beam at high frequencies in sound reproduction is eliminated by the Duplex Speaker. Even at 15,000 cycles plus, the DUPLEX speaker distributes high quality sound 60 degrees horizontally and 40 degrees vertically as compared to the 5 degrees of single unit speakers of comparable size. Another reason why the DUPLEX is the SPEAKER that REVOLUTIONIZES the methods of sound REPRODUCTION.

SEND FOR BULLETINS

# ALTEC

LANSING CORPORATION

1210 TAFT BLDG., HOLLYWOOD 28, CALIF.  
250 WEST 57 STREET, NEW YORK 19, N. Y.  
IN CANADA: NORTHERN ELECTRIC CO.



Just one word—but it's  
tremendously important  
to YOU

**ENGINEERED™**

**E**VERY metal stamping or other part sold under the name of Stewart is engineered to high precision standards. That is why Stewart Stampings and Parts—whether stock patterns or made to your specifications—measure up to requirements 100% in any application.

A rigorous system of inspection, plus constant checking by micrometer and other precision instruments, is your assurance of uniformity—metal of full standard gauge—holes and slots placed in their true positions—and absolute dimensional accuracy.

If your products demand close tolerances, Stewart ENGINEERED Metal Stampings will insure you against the headaches and loss of valuable time on your assembly benches, caused by off-standard stampings of faulty manufacture.

We carry hundreds of items in stock. Our Tool Room is equipped to make dies for your special needs.

All pieces can be furnished in any desired finish.

HOT TINNING  
NICKEL, CADMIUM, SILVER  
AND ZINC PLATING

*Send for Samples and Quotations:  
Let us have your prints and specifications.  
Write for Catalog.*

**STEWART STAMPING COMPANY**  
630 Central Park Avenue, Yonkers, N. Y.

**STEWART**  
**METAL STAMPINGS**

**TERMINALS LUGS BRACKETS CLIPS**

# There's no substitute for ACCURACY

B.R.C. instruments are designed and manufactured to give accurate and precise direct reading measurements with simplicity of operation.

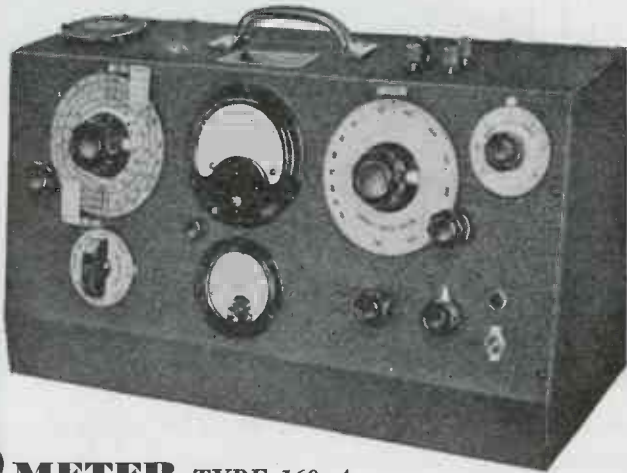

## Q METER TYPE 160-A

A Standard for "Q" Measurements with a reputation for accurate and dependable service. Has a Frequency Range of 50 kc to 75 mc which may be extended with external oscillator down to 1 kc.



## Q METER TYPE 170-A

This instrument retains the same general operating principles and characteristics of the 160-A Q Meter but with such structural modifications and design refinements as are required for accurate performance at higher frequencies. Has a continuously variable frequency range of 30 mc to 200 mc.



**BOONTON RADIO**

BOONTON, N. J.

*Corporation*



DESIGNERS AND MANUFACTURERS OF THE "Q" METER . . . QX-CHECKER . . . FREQUENCY MODULATED SIGNAL GENERATOR . . . BEAT FREQUENCY GENERATOR . . . AND OTHER DIRECT READING TEST INSTRUMENTS

and of equal magnitude. To prevent this effect, the invention combines the carriers in a certain phase relation and also in the opposing phase relation, and the component which is in predominantly aiding phase relation contributes the major portion of the final output.

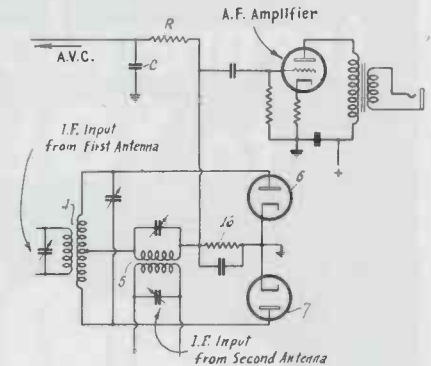

The intermediate frequency signals derived from the first antenna and applied to transformer 4 and the intermediate frequency signals derived from the second antenna and applied to transformer 5 are added in rectifier 6 in a certain phase relationship and in rectifier 7 in opposite phase relationship. If the two intermediate frequency signals are 180 deg. out of phase, they will add in one of the rectifiers, for instance in diode 6, and subtract in the other rectifier. Because resistor 16 is common to both diodes, the bias across it developed by the current through diode 6 will prevent diode 7 from carrying any current so that the output will be supplied by diode 6 only. It can be seen that with two inphase intermediate frequencies diode 7 will exclusively furnish the output. For a 90 deg. relation between the two intermediate frequency carriers both diodes will contribute equal amounts to the output irrespective of the intensities of the voltages across transformers 4 and 5. Between zero and 90 deg. and between 90 and 180 deg. phase difference, one diode will draw more current than the other, biasing the diode drawing the weaker current so that it contributes less to the rectified output than the current passing the higher current.

In two other embodiments shown and explained, the two diodes have separate biasing resistors and both will almost continuously conduct. However, the diode supplied with the greater inphase component will still supply the major portion of the rectified output.

M. G. Crosby, RCA, (F) March 13, 1942, (I) December 12, 1944, No. 2,364,952.

## Two-Way Amplifier

In telephone repeaters, two amplifiers  $A_1$ ,  $A_2$  provide amplification from line  $L_1$  to line  $L_2$  and from line  $L_2$  to line  $L_1$ , respectively. However, these repeaters tend to oscillate because of the feed-back path provided by the amplifiers.

To prevent the generation of oscillations within the repeater a square-wave oscillator

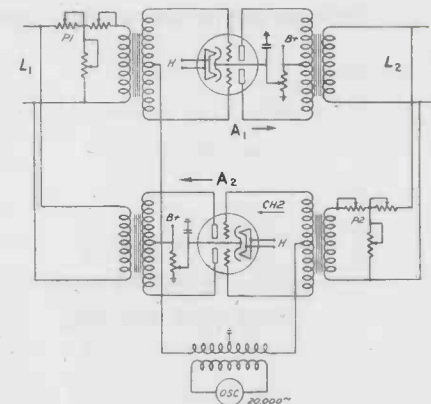

THESE GENERAL  
INDUSTRIES MOTORS ARE  
CERTAINLY SMOOTH

YES, AND YOU  
CAN'T BEAT THEIR  
PLASTIC PARTS



SMALL MOTORS and molded plastic parts, both from General Industries, meet frequently on assembly lines of leading manufacturers. When they do, they match up with precision because of the care and ability which goes into their manufacture.

YOU CAN DEPEND UPON **BOTH**  
FROM GENERAL INDUSTRIES



Our *Smooth Power* drives have been proved for years in our own lines of recorders, record-changers and turntables. Their quick pickup, unvarying speed, velvety smoothness and dependability have kept them favorites for many peacetime products, and have been responsible for their wide military use. Most buyers find what they want in our standard lines, but when specifications are unusual, we design and build them to order.



In our molded plastics division, your blueprints or sketches get close scrutiny by engineers who know plastic compounds and how to use them. Our mold designers study every job to find ways of doing it better, quicker and more economically. As for close tolerances and fine finishes, we refer you to the assembly men and inspectors in the many plants which depend upon us for their molded plastics.

So, you can depend upon General Industries for your postwar needs in both these products. You'll save time by starting general discussions now, to be followed by details when our military commitments have been finished. Please address the specific division . . . *motors or molded plastics.*

THE  
**GI** GENERAL  
INDUSTRIES  
COMPANY  
ELYRIA, OHIO



**YOUR BLUE PRINT  
IS READY...**

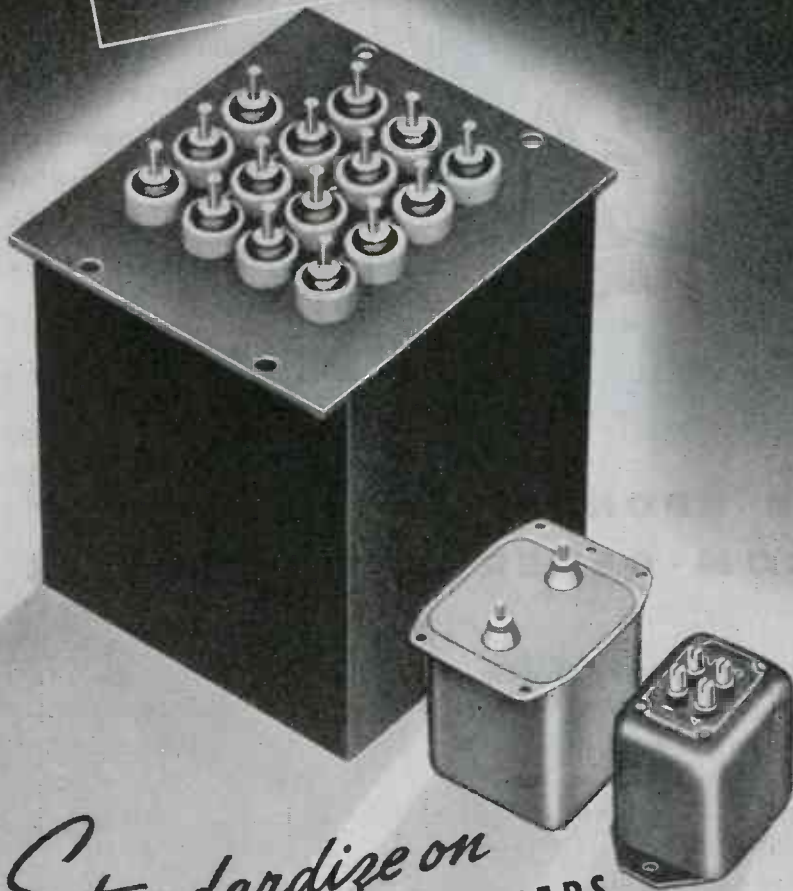

*Standardize on*  
**STANCOR TRANSFORMERS**  
...the precision-built line!

Many startling improvements have come out of our broad war communications experience, which will distinguish Stancor transformers for the future, PLUS a wide expansion into diversified peace-time uses... We are sure that your individual specifications for your post-war designs are present today, in Stancor engineering... May we be of aid in drawing the transformer part of your industrial blue print?

STANDARD TRANSFORMER CORPORATION  
1500 N. HALSTED ST., CHICAGO 22, ILLINOIS



is connected to alternately bias the amplifiers beyond cut-off so that at any time only one of them is operative. The blocking frequency is chosen outside of the audio range, for instance at 20,000 cycles and will not otherwise influence the performance of the apparatus.

H. J. Donaldson, Kellogg Switchboard and Supply Co., (F) July 23, 1941, (I) December 26, 1944, No. 2,366,011.

### Receiver-Transmitter

High sensitivity, simplicity, and elimination of precipitation static present in aircraft reception are the objects of the invention, which provides a single tube circuit to be used either for transmission or for reception.

In the position of the transmitting-receiving switch 39 as shown, the equipment is ready for reception. Grid 48 functions as plate for the first, or amplifier, tube section 45,34,48, and also as cathode for the second tube section 48,55,49,56,57, which operates as oscillator at received signal frequency.

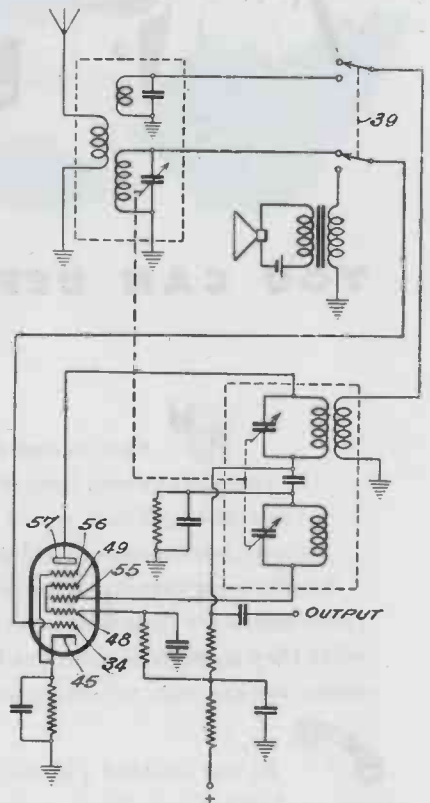

If the oscillator grid 55 is suitably biased and the proper amount of energy is fed to it from the oscillator tank circuit, the plate current of the oscillator section will be zero during the negative grid swing. During the positive swing of the oscillator grid 55, the plate current has the positive peaks of the amplified signal riding on it, and since the negative portion of the received signals has been eliminated, the signal is detected. Furthermore, if the oscillator grid is properly biased, amplification takes place, as in the first detector of a superheterodyne.

High selectivity is provided so long as the interfering signals are not sufficiently strong to cause detection on grid 34 of the first tube section. The high selectivity is due to the fact that good detection occurs only when the local oscillator is operating substantially at the carrier frequency and in phase with the carrier.

In the transmitting position of switch 39, modulating potential is applied to control grid 34 and impressed upon the oscillations generated by the second tube section.

R. H. George, (F) December 31, 1942, (I) January 2, 1945, No. 2,366,329.

(Turn to page 134)



The *Quiz Kids* say:

**"DUMONT TELEVISION IS COSMIC LEGERDEMAIN"**

You will agree that these diminutive stars, while rarely at loss for correct answers, are seldom available when prospective operators of postwar Television stations have questions to ask. Fortunately, DuMont Television "know how" can be tapped as needed... cost and engineering data on every phase of station design, construction and operation... the accumulated knowledge gained through more than 4 years' station management and production of programs.

The low operating cost, extreme flexibility and rugged dependability of DuMont Television

transmitting equipment are being convincingly demonstrated week-in and week-out in 3 DuMont-equipped stations. New postwar designs embody all wartime advances. You can arrange *now* for early peacetime delivery of station equipment and training of personnel through the DuMont Equipment Reservation Plan. Visit DuMont's Station WABD, New York. Call, write or telegraph for appointment... Station Equipment Sales Division, Allen B. DuMont Laboratories, Inc., 515 Madison Avenue, New York 22, N. Y.

\*Appearing Sunday evenings on the Blue Network.

Copyright 1945, Allen B. DuMont Laboratories, Inc.



ALLEN B. DUMONT LABORATORIES, INC., GENERAL OFFICES AND PLANT, 2 MAIN AVENUE, PASSAIC, N. J.  
TELEVISION STUDIOS AND STATION WABD, 515 MADISON AVENUE, NEW YORK 22, NEW YORK

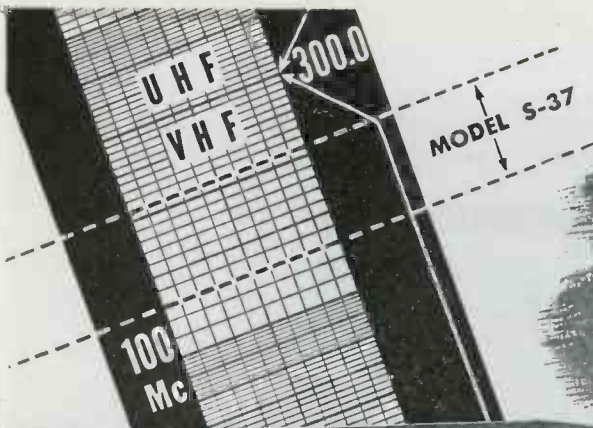

# HOW hallicrafters EQUIPMENT COVERS THE SPECTRUM



**T**HE new Model S-37 FM-AM receiver is an outstanding example of Hallicrafters pioneering work in the upper regions of the spectrum. Covering the frequencies between 130 and 210 megacycles, the S-37 provides VHF performance which is in every way comparable to that of the finest communications receivers operating in the medium and high frequency bands. The average over-all sensitivity of the S-37 is approximately 5 microvolts. The image ratio of at least 1000 times is achieved through the use of two pre-selector stages and an intermediate frequency of 16 megacycles. No band switching is necessary and exceptional ease of tuning is provided by mechanical band-spread with 2300 dial divisions between 130 and 210 megacycles. The pre-loaded gear train is completely enclosed and is equipped with a positive stop at each end of the tuning range. Hermetically sealed transformers and capacitors, moisture proof wiring, and extra heavy plating, all contribute to the long life and reliability of the S-37 . . . the only commercially built receiver covering this frequency range.

The amazing performance of the Model S-37 is largely due to the RF section shown at right. It is mounted as a unit on a brass plate  $\frac{1}{4}$  inch thick. The two type 954 RF amplifiers and the type 954 mixer are placed in the heavy shields which separate the stages. The type 955 oscillator is mounted directly on its tuning condenser. Exceptional stability is assured by the use of individually selected enclosed ball bearings, extra-heavy end plates, and wide spacing in the oscillator condenser - rigid mounting of all components - and inductances of  $\frac{1}{8}$  inch copper tubing wound on polystyrene forms. All conducting parts are heavily silver plated.

*Model S-37*  
FM-AM  
for very high frequency work  
130 to 210 Mc.

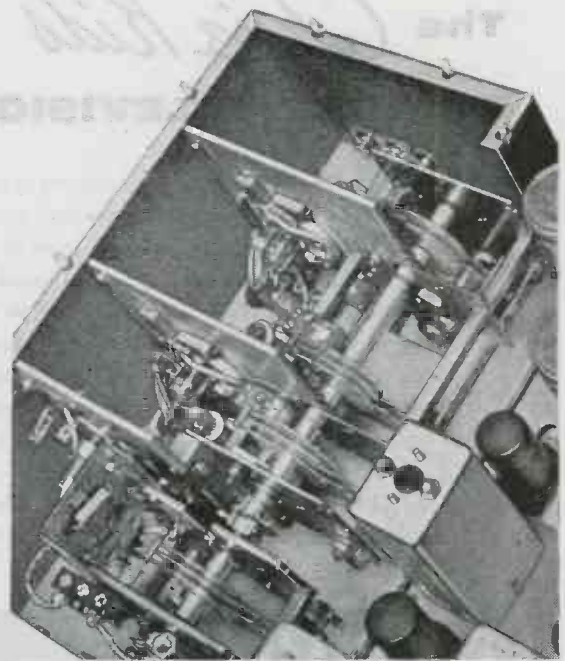

Write for Catalog No. 36D, describing Hallicrafters complete line of high frequency receivers and transmitters.

BUY A WAR  
BOND TODAY!

# hallicrafters RADIO



THE HALLICTRAFTERS CO., MANUFACTURERS OF RADIO AND ELECTRONIC EQUIPMENT, CHICAGO 16, U.S.A.

...for product planners

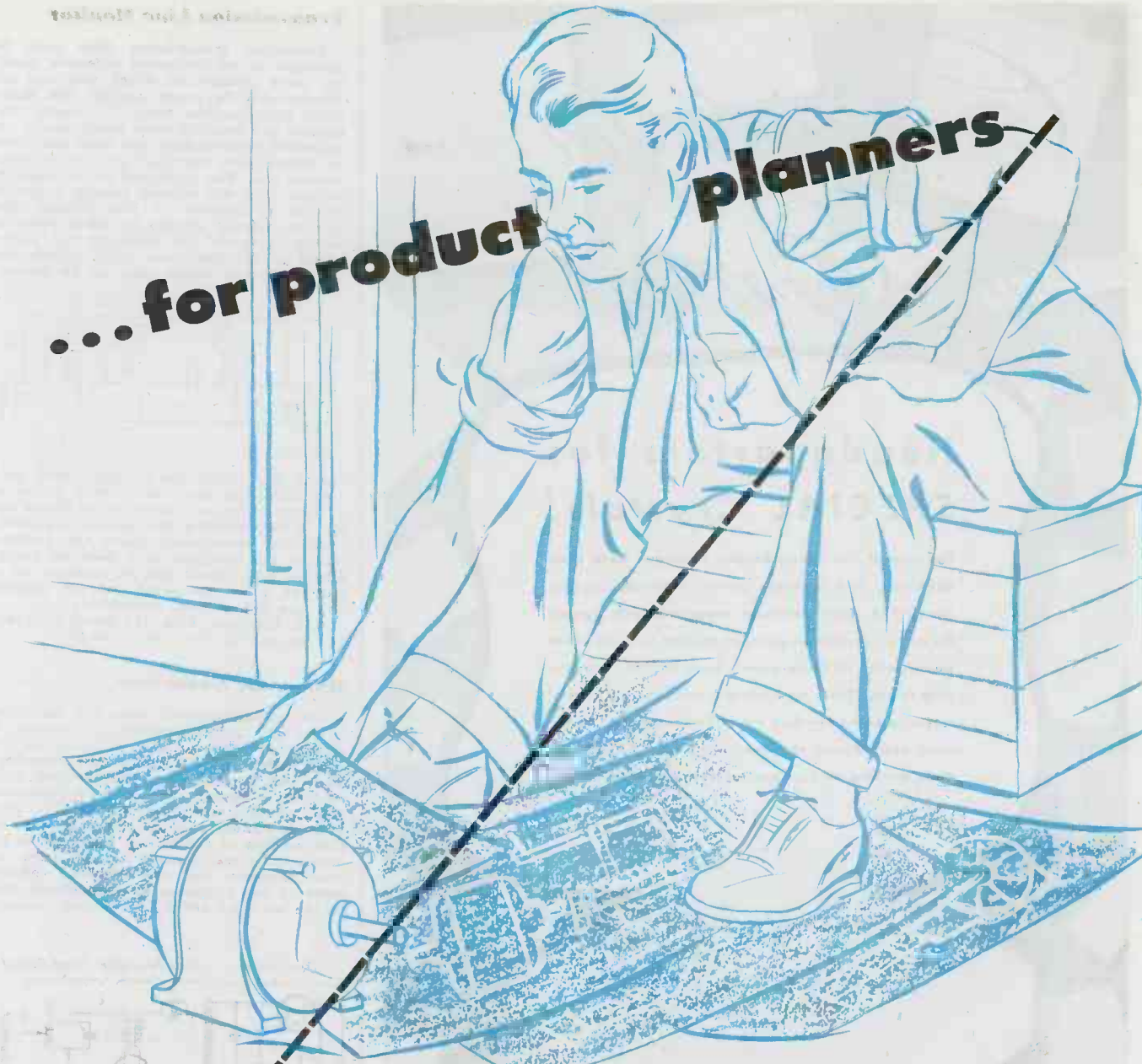

*a better spring service*

Product planners with springs on their minds will find it helpful to talk things over with Accurate Engineers. For we're planning better products too—better springs, better engineering and better service. These are really more than plans—they have been tested and proved in Accurate's all-out production of fighting springs. We are still "all out" of course. But Accurate men and machines and methods are ready to produce the precision springs you'll want for your better products... whenever you are ready.



SPRINGS  
WIREFORMS  
STAMPINGS



Send for your copy of the new Accurate Spring Handbook. It's full of data and formulae you will find useful. No obligation, of course.

**ACCURATE SPRING MANUFACTURING CO.**  
3808 W. LAKE STREET CHICAGO 24, ILLINOIS

*Crystals for  
the Critical...*

**Headquarters for  
SPECIAL Crystals!**

The men of The James Knights Company have been designing and making special precision crystals since 1932. Their extensive experience with crystals for every conceivable purpose, coupled with an active participation in Radio dating back to 1913, is available to you. These men are interested in your special crystal problems — they have the knowledge, equipment and research facilities to help you. Why not get them working on your special crystal problem today?



**The JAMES KNIGHTS Co.**  
SANDWICH, ILLINOIS  
Sixty Miles South West of Chicago

**Transmission Line Monitor**

Concentric transmission lines may be damaged by an accidental excessive standing wave voltage for which they are not dimensioned. To guard against this possibility three rectifier tubes 17, spaced one-quarter and one-half wave length apart, are connected between inner and outer conductor or between the two lines of a wire transmission line. Bias is applied to the rectifiers so that they will respond beyond a desired amount of increase in line voltage. The rectifier outputs actuate an alarm relay or switching means for disabling the transmitter at the line input. Alternatively the rectifier output circuit may be so propor-

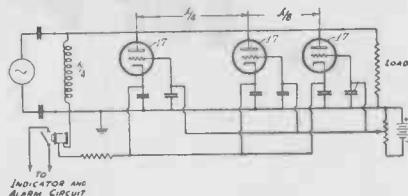

tioned that, when the rectifiers draw current from the line, the current drawn is sufficient to prevent the potential across the line from exceeding the desired maximum.

Another embodiment shows the application of the invention to a balanced transmission line. Each tube is replaced by a pair of tubes connected between ground and one line section, respectively.

G. L. Usselman, RCA, (F) March 18, 1942, (I) January 2, 1945, No. 2,366,660.

**Harmonic Generator**

The voltage derived from the oscillator causes the pulse generator to provide a short current pulse  $i$  of great amplitude for each cycle of the fundamental frequency. The pulse generator tube is connected as a blocking oscillator;  $L_1$  and  $L_2$  are regeneratively coupled and sufficiently small to produce oscillations of a frequency at least as high as that of the highest harmonic to be used. Only one positive current pulse of this frequency for each positive voltage pulse of the fundamental is generated due to the blocking action of the grid current.

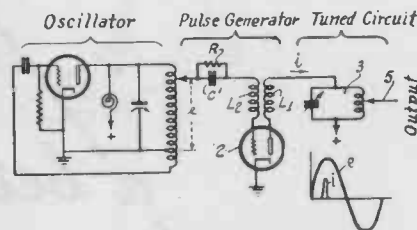

Circuit 3 is tuned to the desired harmonic and the tuning of this circuit is the only adjustment required for obtaining either the fundamental frequency or any harmonic. It will oscillate at its resonant frequency under the influence of the short current pulses which supplement the dissipated energy. As long as the Q-value of the tank coil is unaltered and the duration of the pulses is short compared to the duration of a half cycle of the harmonic frequency, substantially the same voltage will be developed in the tank circuit 3, regardless of the order of the harmonic to which it is tuned.

W. van B. Roberts, RCA, (F) July 1, 1942, (I) December 12, 1944, No. 2,364,756.

**Blocking Oscillator Control**

It is intended to adjust the speed of a blocking oscillator by remote control without causing any interaction with the associated television or audio receiving equipment. For this purpose a potentiometer is inserted between the plate supply and ground and the variable arm provides adjustable bias for the discharge tube.

E. I. Anderson, RCA, (F) October 29, 1942, (I) January 2, 1945, No. 2,366,307.



# Announcing

a distinct advance in small-capacitor design

## GLASS TERMINAL SEALS

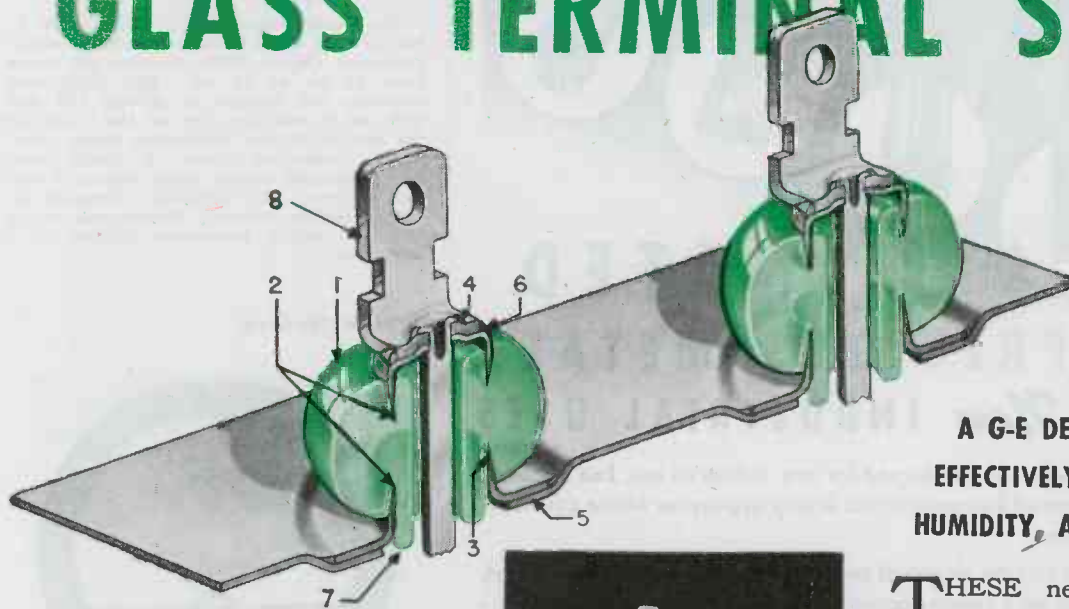

**A G-E DEVELOPMENT THAT  
EFFECTIVELY RESISTS FUNGUS,  
HUMIDITY, AND THERMAL SHOCK**

**T**HESE new terminal seals for small capacitors are based on the many glass-to-metal seal developments pioneered by our Research Laboratory and Lamp Department over a period of years. The seal is similar, in many respects, to the seals being used so successfully to maintain a high vacuum indefinitely in G-E sealed-beam headlamps, millions of which are now in use.

This development makes possible a capacitor seal that will withstand the most severe operating conditions—sudden or prolonged heat or cold, high altitude, rain, humidity, fungus, and microscopic animal infiltration. It differs from most glass-to-metal seals in that it does not *rely* on soft solder for mechanical strength, nor on matched coefficients of expansion of glass and metal to resist thermal shock.



G-E Pyranol capacitor (case style CP-62) equipped with glass terminal seals

expansion of glass and metal to resist thermal shock.

G-E capacitors equipped with glass terminal seals are, at present, available in case styles CP-60, -62, and -64 in all ratings covered by proposed specification JAN-C-25, for use in combat communications equipment where severe operating conditions may be encountered. Ask for Bulletin GEA-4424 for complete information. *General Electric Company, Schenectady 5, N. Y.*

Buy all the BONDS you can—and keep all you buy

**GENERAL  ELECTRIC**  
407-90-5700

**1** Exceptionally stable, low-expansion glass, practically unaffected by weathering, microorganisms, and thermal shock.

**2** Metal sections, made of corrosion-resistant nickel steel, are sealed into opposite ends of the glass by a heating process in which the oxide on the steel is fused into the glass to form an impervious bond between the two.

**3** Metal sections are tapered to keep stresses in the glass at negligible values under thermal-shock conditions. The seal is designed to pass American War Standard thermocycle tests with a wide margin of safety.

**4** High mechanical strength is provided because terminal is *riveted* to top metal section, and,

**5** Terminal seal is brazed to capacitor cover.

**6** All joints are hermetically sealed. *None relies* on soft solder for mechanical strength.

**7** Adequate electrical clearance between lead and case is maintained by the glass skirt.

**8** Easy attachment of external leads is assured by making terminal of *solder-dipped* brass.



# LAMINATED PRECIOUS METALS *for New* INDUSTRIAL USES

Laminated wire can be shaped for any industrial use, has application in many types of instruments and in any apparatus where corrosion must be prevented.

Typical uses include electrical contact strips, formed plated springs, low cost electric wire (silver-coated steel), radio electronic parts . . . where expansion must be held to a minimum (silver on invar) . . . or any project where electrical superiority, durability, or corrosion resistance is important.

Gold, silver, platinum and palladium or special precious metal alloys laminated to base metal have made these things possible . . .

- The desirable electrical, mechanical or chemical qualities of the precious metals have been added to the strength or other desirable properties of base metals, precisely where and as required.
- Precious metal properties of corrosion resistance, electrical superiority, and durability are obtained without solid precious metal costs.
- Uniform maintenance of lamination ratios with no porosity, pit marks or defects.
- Finer, more lasting finishes than are otherwise obtainable in base metals.

To assist you in the application of our products to your products we are maintaining a staff of thoroughly experienced metallurgists, chemists, designers and consultants . . . an up-to-date research and testing laboratory . . . and a splendidly equipped tool room. These are all at your service to cooperate with your own staff to the full extent of our facilities.

Your inquiries are cordially invited. Ask, too, for a copy of our new descriptive folder.



**Makepeace** PRODUCTS  
SHEETS • WIRE • TUBING • SOLDERS  
FABRICATED PARTS AND ASSEMBLIES

**D. E. MAKEPEACE COMPANY**

Main Office and Plant, ATTLEBORO, MASS.

New York Office, 30 Church St.

## WHAT'S NEW



### Signal Generator

The Ferris Instrument Co., Bonton, N. J., has brought out a new and improved signal generator (Model 22D) covering the range from 85 kc. to 40 mc. This instrument combines the features of Models 22A and 22B and in addition provides the output at the end of 30-ohm terminated cables eliminating connection errors. A special four-inch calibrated output meter improves output accuracy and simplifies operation by eliminating one control. Exceptional care is taken to reduce extraneous leakage to a minimum.

### Sealed Meters

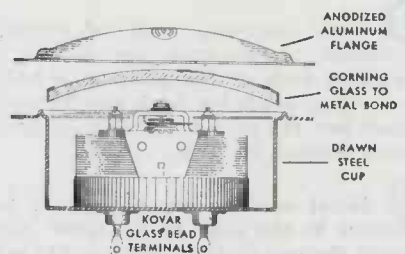
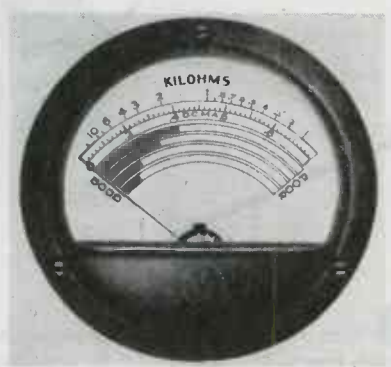

A new series of hermetically-sealed 2½ in. and 3½ in. meters has been developed by the Marion Electrical Instrument Co., Manchester, N. H. The sealing has been effected by building the mechanism into a protective cup-like frame, the construction requiring neither rubber gaskets nor cement. The glass cover is sealed to the metal rim by a method similar to the manner in which vacuum tubes use metal-to-glass seals. The instruments are dehydrated, magnetically shielded and, where extra rf shielding is required, may be supplied with a silver plating. The instruments have silver clad beryllium copper hair springs and are supplied in all normal dc ranges.

### Assembly Construction

A new prefabricated light metal construction, known as Lindsay Struc-Lok, which provides manufacturers with a simplified method of making enclosures for electrical and electronic equipment, has been developed by Lindsay & Lindsay, 222 West Adams St., Chicago. Struc-Lok, which is

**WEBSTER**



**CHICAGO**

*Announces the acquisition of*  
**WEBSTER PRODUCTS**

The former Webster Products organization and facilities will be retained intact and will operate as the Electronics Division of Webster-Chicago Corporation. This division is now manufacturing dynamotors and voltage regulators for the war program.

For peacetime production, the Electronics Division will resume manufacture of Webster Record Changers as well as several new, but related products, already designed and ready for postwar production. Watch for later important technical and merchandising information over this new signature.

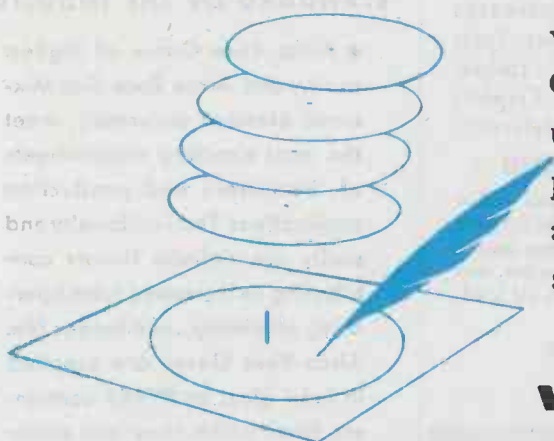

Again Postwar, You Will Find Webster Record Changers in High Quality Combinations

**WEBSTER**



**CHICAGO**

**ELECTRONICS  
DIVISION**

3825 ARMITAGE AVENUE, CHICAGO 47, ILLINOIS

FAST, RELIABLE SOURCE FOR

*Leading Makes of*

# INDUSTRIAL ELECTRONIC INSTRUMENTS



**For Measurement,  
Inspection,  
Testing and Control**

TUBE TESTERS  
OSCILLOSCOPES  
CAPACITY DECADES  
RESISTANCE DECADES  
WHEATSTONE BRIDGES  
RESISTANCE LIMIT BRIDGES  
WEIN CAPACITY BRIDGES  
SIGNAL GENERATORS  
PANEL METERS  
VACUUM TUBE VOLTMETERS  
VOLT-OHM-MILLIAMMETERS

**Helpful  
BUYING  
GUIDE**  
Available  
on Request  
Write for it!

Allied's concentration of leading makes *under one roof* means you can obtain the type of instrument you want . . . *in the shortest time possible*. This specialized service to industry, government, and research laboratories simplifies procurement . . . increases efficiency . . . saves hours, days, and effort. Such well known makes as RCA, Dumont, G.E., Industrial Instruments, Hickok, Radio City, Triplet and others. Many on hand for immediate delivery.

## EVERYTHING IN ELECTRONICS AND RADIO

It's faster, simpler to get all your electronic and radio supplies from this one central source. We carry the largest and most complete stocks of parts and equipment under one roof . . . ready for immediate shipment. Besides, our procurement experts are in constant contact with all leading manufacturers to speed supplies.

*Save time and work . . . Call Allied First!  
Write, Wire or Phone Haymarket 6800*

# ALLIED RADIO

CORPORATION

833 W. Jackson Blvd. Dept. 32-E-5 Chicago 7, Illinois

SUPPLIERS OF ELECTRONIC PARTS AND EQUIPMENT TO INDUSTRIAL AMERICA

Electronic Tubes, Rectifiers, Power Supplies, Intercommunicating Systems, Sound Systems, Photo-Cell Equipment, Batteries, Chargers, Converters, Generators, Supplies for Resistance Welders, Fuses, Test Instruments, Meters, Broadcast Station Equipment, Relays, Condensers, Capacitors, Resistors, Rheostats, Transformers, Switches, Coaxial Cable, Wire, Soldering Irons, Microphones, Speakers, Technical Books, etc.

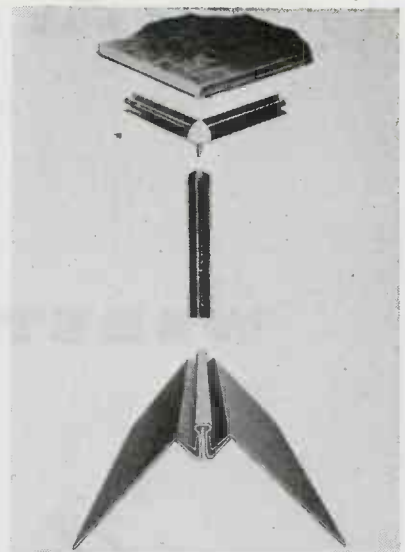

based on a patented method of snap-assembly requiring no bolts, screws, rivets, or welds, has been developed by the company to complement its other product, Lindsay Structure, and to extend the advantages of prefabricated metal assembly to a much broader field. Struc-Lok is fabricated in both aluminum and steel and consists of three basic parts: framing, sheets, and fittings. All parts are die-formed in a wide variety of sizes. Assembly can be easily handled by men or women without special training, as all of the parts snap together by hand—no screws, bolts, rivets, or welds are required. Struc-Lok is available with sheets in 26 and 24 gage steel and .020 to .030 in. thickness of 61 ST alloy aluminum. Perforated or expanded metal sheets may also be used. Openings, louvers, doors, and other conventional construction details are easily incorporated.

## AIRCO RARE GASES AND MIXTURES OF TESTED PURITY

STANDARD OF THE INDUSTRY

● Airco Rare Gases of highest purity, and Airco Rare Gas Mixtures, blended accurately, meet the most exacting requirements of laboratory and production applications. Their uniformity and purity are definite factors contributing to increased tube operating efficiency...and longer life. Airco Rare Gases are supplied in lead glass or PYREX containers from which they are easily removed with no change in quality. Your nearby Airco Office can supply your needs quickly.

## AIR REDUCTION

60 EAST 42nd STREET • NEW YORK 17, N. Y.

Offices in Principal Cities

ARGON • NEON • HELIUM • KRYPTON • XENON  
STANDARD AND SPECIAL MIXTURES



*A new twist in*

# LUMARITH\* CA

**TO BAR THE BLACK HAND OF CORROSION**

IN EFFECTIVELY blocking electro-chemical corrosion, Lumarith CA provides the planned, built-in protection possible with synthetics—freedom from organic decomposition and other hazards natural to many materials.

Lumarith CA resists the effects of transformer oil. It maintains high dielectric strength under the most adverse conditions of humidity. Lumarith CA films and foils are tough and flexible. They ruggedly maintain coverage, assure crack and fold-break resistance, and provide low space-factor. Special mat finish (A78) prevents slippage in winding and other applications, and provides ample elongation. Lumarith CA is a favorite with laminators. Also available in sheets, rods, tubes and molding materials. Send for the reference booklet, "Celanese Synthetics for the Electrical Industry." Celanese Plastics Corporation, a division of Celanese Corporation of America, 180 Madison Ave., New York 16, N. Y.

\*Reg. U. S. Pat. Off.

**EXECUTIVES!** Just published, 136 page manual entitled, "FABRICATING METHODS FOR LUMARITH\* CELLULOSE\* AND SIMILAR THERMOPLASTIC MATERIALS." Write for complimentary copy on your company letterhead. Additional copies, \$1 each.

*A Celanese\* Plastic*



## SPIRAL WOUND LUMARITH TUBING—

highly crush-resistant and with the same high voltage breakdown of other forms of Lumarith CA. Wide range of lengths, diameters and wall thicknesses suitable to many applications. Ideal in grommets—furnished one end spun for tight, lasting fit. Also for spaghetti, and coil cores with or without flanges.



*Jennings*  
-RADIO-

VACUUM ELECTRONIC COMPONENTS

# "WALNUT" CAPACITORS

REVOLUTIONARY IN DESIGN, SIZE, WEIGHT

PATENT APPLIED FOR.— PHOTOGRAPH SHOWS SIZE OF JENNINGS "WALNUT" CAPACITOR IN RELATION TO HAND.

The latest and most highly successful electronic component is the Jennings "Walnut" size Capacitor, now in full production.

## **WALNUT VC, SERIES M — AMPERE SERIES 20**

### CHARACTERISTICS

Capacity Range 6-50 mmfd.

Maximum Current 20 Amperes Peak

Maximum Voltage 30KV Peak

Specially designed for high frequency operation

Self-healing in case of overload

We can now accept orders for early delivery of this greatly improved, compact, plug-in type capacitor.

WRITE FOR BULLETIN EI

JENNINGS RADIO MANUFACTURING COMPANY • 1098 E. WILLIAM ST. • SAN JOSE 12, CALIFORNIA

# MARION INSTRUMENTS



GEARED TO  
EVER-CHANGING  
NEEDS OF  
INDUSTRY

War requirements, plus our own design and construction refinements, now provide industry with instruments of heretofore unknown qualities. As new needs arise, we are geared to use our highly specialized, yet diversified, knowledge in solving any measurement problem.

Solid Alnico magnets  
Beryllium copper frames  
Sintered soft iron pole pieces  
Very high torque movements

Our engineering department welcomes inquiries — especially those demanding extra-critical instruments for special applications.



MARION ELECTRICAL INSTRUMENT CO.  
MANCHESTER, NEW HAMPSHIRE

Distributed by ELECTRICAL INSTRUMENT DISTRIBUTING CO.  
458 BROADWAY - NEW YORK, N. Y.

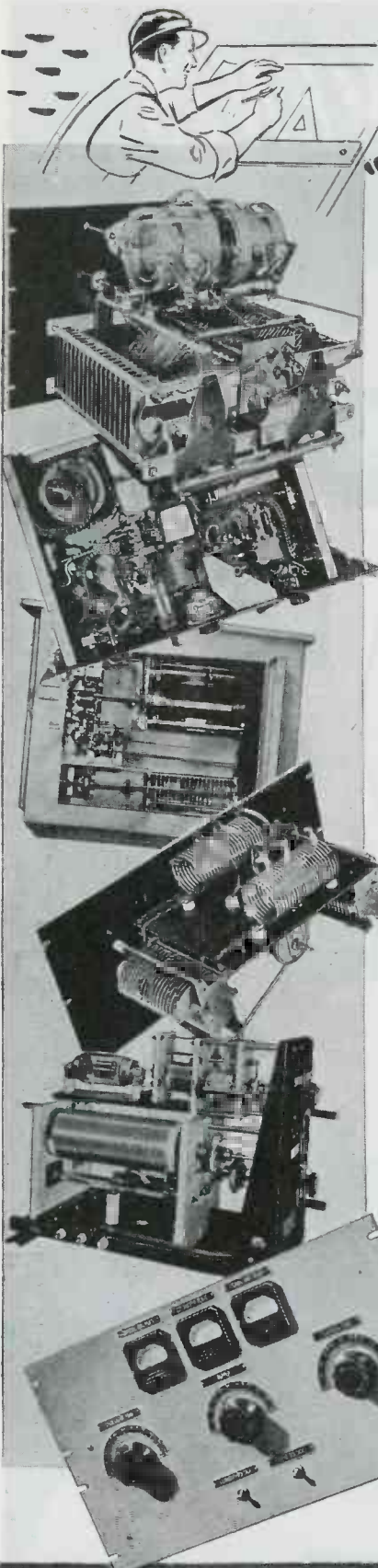

*"Tailor-made"*

# ELECTRONIC EQUIPMENT ASSEMBLIES

Designed and produced from stem to stern by recognized experts to match your needs *exactly*.

**DIELECTRIC & INDUCTION HEATING EQUIPMENT**

**TUNING UNITS**

**TEST EQUIPMENT**

**RADIO TRANSMITTERS**

**HIGH AND ULTRA-HIGH FREQUENCY EQUIPMENT**

*B&W is neither too large for the smallest job nor too small for the largest. Write for details, outlining your requirements.*



**BARKER & WILLIAMSON**

AIR INDUCTORS • VARIABLE CONDENSERS • ELECTRONIC EQUIPMENT ASSEMBLIES

DEPT. EL-55, 235 FAIRFIELD AVENUE • UPPER DARBY, PA.

Export: LINDETEVES, INC., 10 Rockefeller Plaza, New York, N. Y., U. S. A.

## Electronic Counter



The Potter Instrument Co., 136-56 Roosevelt Avenue, Flushing, N. Y., has a new two-decade electronic counter designed for industrial and laboratory uses. The counter is actuated by a closing contact, sine wave, or pulse input, as from a photocell, at rates up to 1,000 cycles per second. Each decade divides by ten, giving a scaling factor of 100. The count for 0 to 99 appears on two banks of neon lamps. A telephone-type relay is connected to the counter output and the contacts of this relay close once for each 100 input cycles. These contacts are connected to an output terminal. A conventional electro-mechanical counter may be connected to the output terminals to extend the count to as many places as desired. An application of the Potter unit lies in counting rates exceeding 10 cycles a second, which are generally too fast for conventional counters; or in installations where a conventional counter wears out prematurely from high speed continuous operation or is unreliable. The electronic counter makes it possible to increase the counting rate 100 times. The equipment uses a complement of 11 tubes; can be supplied with switches to make it predetermining. Operation is from a 60 cycle, 105 to 125 volt line.

## WIRE, RIBBON and Other Metal Products

★ *Smaller than Commercial Sizes; closer than Commercial Tolerances*

An organization devoted to the research, development and production of wire and ribbon and similar products of Platinum and other Precious Metals, as well as Rare and Base Metals... This metallurgical plant is completely equipped with alloying, melting and working facilities for precision production. Equipment and staff permit specialization in smaller than commercial sizes and closer than commercial tolerances for the most exacting technical requirements.



**SIGMUND COHN & CO.**

44 Gold Street • New York 7, N. Y.



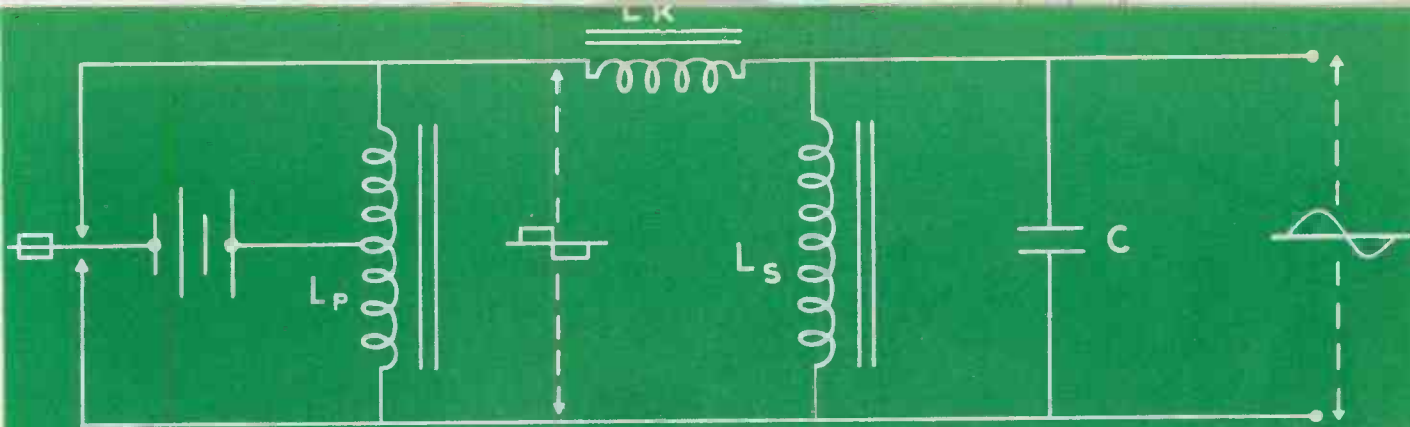

## NOW, A VIBRATOR POWER SUPPLY WITH A SINE WAVE OUTPUT

● For years, it has been taken for granted that the output wave form of a Vibrator Power Supply necessarily must be a rectangular wave with its characteristic "swingback" or commutation lines. With the development of very sensitive radio equipment this, of course, caused shock excitation of the audio and RF tuned circuits. In equipment designed for sine wave, operation on square wave resulted in the wrong ratio of A and B voltages applied to the tubes.

Realizing the need for eliminating the difficulties arising from square wave operation, Electronic Laboratories research department has perfected a Vibrator Power Supply which can supply a sine wave at powers up to several hundred watts from any DC source. In addition, this output is stable and has excellent regulation characteristics with load and input voltage.

Referring to the diagram at the top of this page,  $L_k$  (leakage reactance) and the condenser, "C", form a series resonant circuit. This circuit establishes a voltage across the secondary inductance  $L_s$ . This voltage rises as  $L_k$  is varied until it is established by the saturation of the secondary inductance  $L_s$ . The saturation characteristic of the inductance,  $L_s$ , is such as to sustain sinusoidal voltage across the condenser, "C". This results in a smooth sine wave output voltage, substantially independent of the input voltage.

An elementary form of this system is shown in figure 1. The power transformer consists of a primary winding, "P", energized from the battery through the vibrator. The secondary winding, "S", is separated from the primary by magnetic shunts, and the tank condenser, "C", is across the secondary winding.

Since the reactive energy stored in the system is large, compared to the actual energy dissipated by

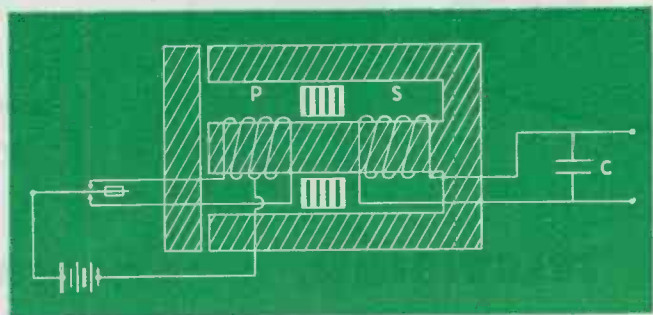

Figure 1

the load, this system is also independent of load changes.

Careful design of the primary circuit insures proper commutation for long life and reliability. Any number of voltages can be had from the system by properly tapping the tank circuit.

\* \* \* \* \*

$\mathcal{E}\mathcal{L}$  Vibrator Power Supplies have wide application in many fields: radio, electrical, electronic, marine, aviation and railroad. Their high efficiency and versatility with multiple inputs and outputs, enable them to meet many power supply needs. They may be designed to provide any wave form required for specific equipment. . . Economy is assured because of long, efficient service with minimum maintenance.  $\mathcal{E}\mathcal{L}$  Engineering Service is available to discuss your power supply problem and to design a vibrator power supply to meet specific voltage, power, size and weight requirements.

Model illustrated is a typical  $\mathcal{E}\mathcal{L}$  Vibrator Power Supply with sine wave output and voltage regulation.



**Electronic**  
**LABORATORIES INC.**  
INDIANAPOLIS





**Coaxial Equalizer**

By use of the newly developed Coaxial Equalizer, the Induction Heating Corp., 389 Lafayette St., N. Y. 3, N. Y., is now able to couple two of its standard model 1070 thermionic induction generators so that the full output of both can be obtained from a single set of terminals. Since each of the Model 1070 Generators has an output of 1070 Btu's per minute, full 40 kw of power is available for use in any desired application with a single control station operating the tandem generator set-up. The installation of the coaxial equalizer (made up of concentric tubular conductors) requires only the connection of the equalizer to the output terminals of the generators. An additional inter-connection is made between the power sections of the generators to give electrical stability. The equipment can be operated single phase, two phase or three phase, making it possible to install the equipment from any power supply with the full load power factor at approximately 90 per cent.

**TELEVISION, SINCE PIONEER DAYS, HAS DEPENDDED UPON CANNON PLUGS**

Because Cannon Plugs and Receptacles were designed especially for use in critical circuits, they were incorporated into the first television hook-ups. Says Harry R. Lubcke, Director of Television for the Don Lee Broadcasting System:

*"We find Cannon Connectors indispensable in our television operations. We called on Cannon in 1937 and what was probably the first all-television connector was fabricated."*



All the circuits of a modern television camera pass through this single master Cannon Connector mounted on the side of the instrument. Equipment for the control of focusing, power and intensity of image is connected to power sources and to pick-up and broadcasting equipment through Cannon Plugs.

If you are interested in equipment of this kind, write for Cannon Condensed Catalog. Address Dept. A-122, Cannon Electric Development Company, 3209 Humboldt Street, Los Angeles 31, Calif.



**CANNON ELECTRIC**

Cannon Electric Development Co., Los Angeles 31, Calif.  
Canadian Factory and Engineering Office: Cannon Electric Company, Ltd., Toronto, Canada

REPRESENTATIVES IN PRINCIPAL CITIES—CONSULT YOUR LOCAL TELEPHONE BOOK

**WE TAKE THE WORRIES OUT OF YOUR HANDS!**

OUR SPECIALTY

↓

**FABRICATING MYCALEX**

IN ALL FORMS, to Specifications

**COLONIAL KOLONITE COMPANY**  
2212 W. ARMITAGE AVE., CHICAGO, ILL.

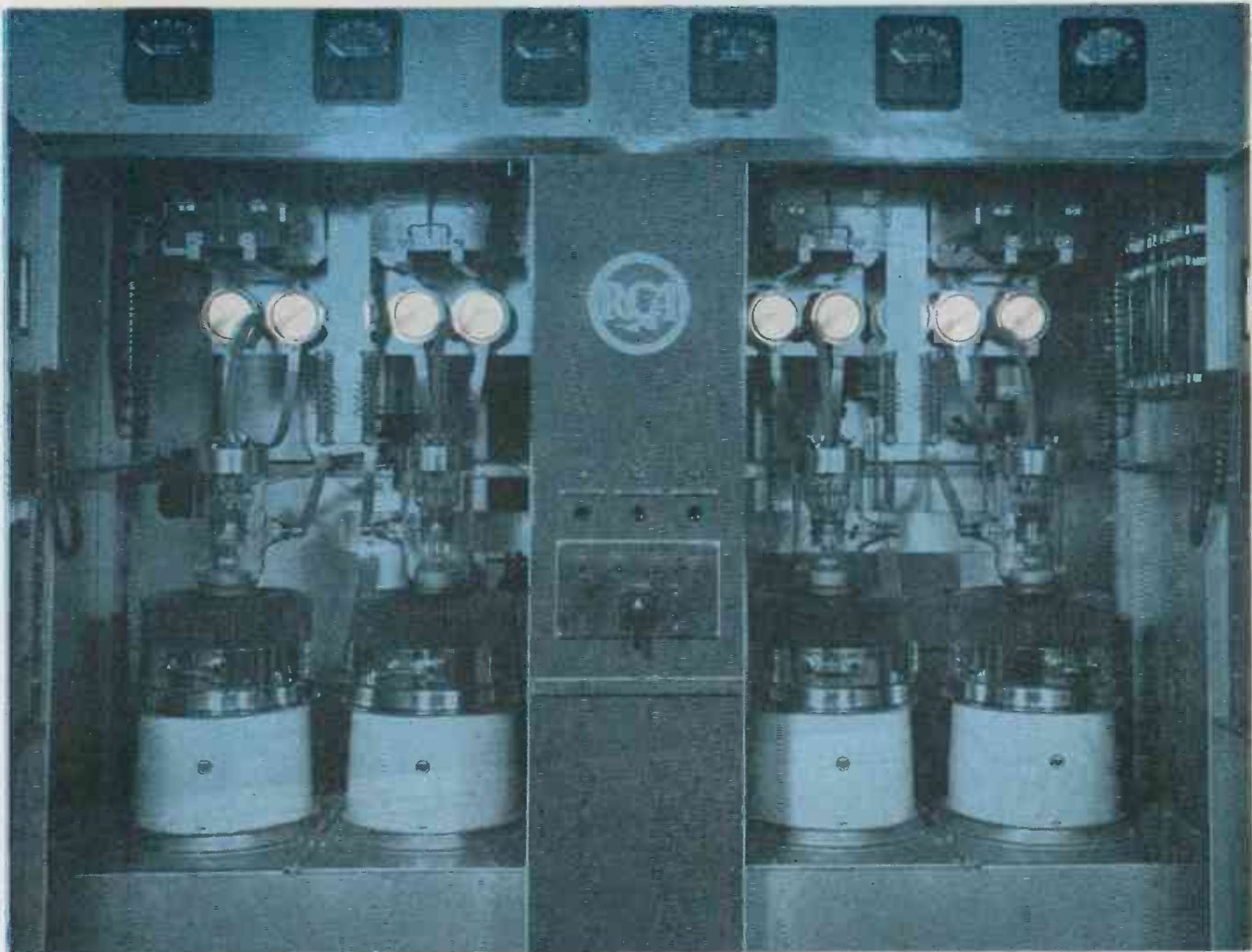

## *Faradon Capacitors for Broadcast Transmitters*

**S**INCE the earliest days of radio broadcasting, Faradon Capacitors have been used in a large proportion of the transmitters built for leading broadcast stations. They are equally popular with manufacturers of police radio transmitters...aircraft radio transmitters...transmitters for the armed forces...and in many types of industrial electronic machines and appliances.

Why are Faradon Capacitors specified

for this wide range of uses? First... because of their established reputation for dependability. Second... because they include all types and sizes of mica capacitors. No matter why, or for what, you need a mica-type capacitor, there is an RCA Faradon that will "fill the bill."

For complete information on Faradon Capacitors, for *any* purpose, write to the Engineering Products Department 113F RCA Victor Division, Camden, N. J.



BUY MORE WAR BONDS

### RADIO CORPORATION OF AMERICA

RCA VICTOR DIVISION • CAMDEN, N. J.

In Canada, RCA Victor Company Limited, Montreal

USE

# Erie Ceramicons

REG. U.S. PAT. OFF.

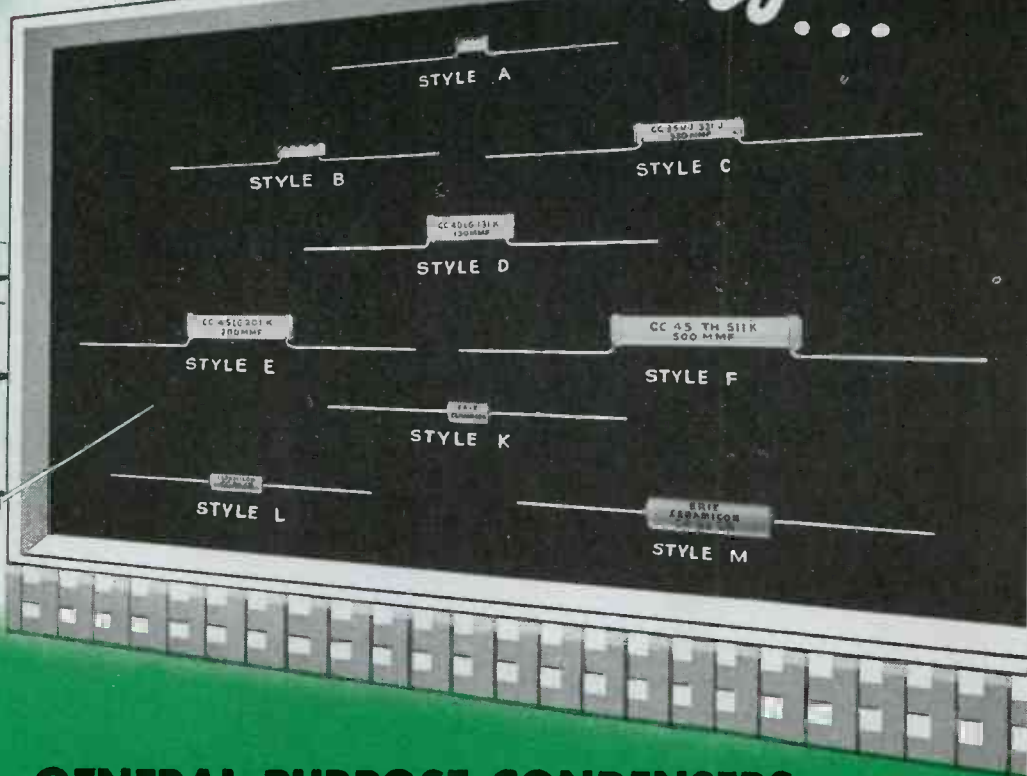

## GENERAL PURPOSE CONDENSERS

Available in 10 Standard Temperature Coefficients

THE tremendous wartime demand for condensers has provided a splendid opportunity to prove the reliability and adaptability of Erie Ceramicons\* as extremely stable, general purpose capacitors, in circuits where a moderate degree of capacity change with temperature is permissible.

Originally designed and developed almost a decade ago to provide engineers with a simple and effective method of compensating for frequency drift in other components, Erie Ceramicons are now being used in a wide range of applications with complete success.

Erie Ceramicons are available in ten standard coefficients ranging from +120 to -750 parts/million/°C, inclusive. Capacity ranges, style designations, and dimensions are given in the chart at the right.

When specifying Ceramicons under JAN-C-20 for general purpose use, temperature coefficient characteristic "SL" should be given. If Erie designations are used, specify "any temperature coefficient between P100 and N750." The temperature coefficient of these Ceramicons will be between +150 and -870 parts/million/°C. In many cases,

particularly in the low capacity ranges, these temperature coefficient limits will permit us to ship from stock. We will gladly submit samples of Erie Ceramicons to you for your general purpose applications.

### CHARACTERISTICS

CAPACITY RANGE IN MMF	JAN-C-20 STYLE	ERIE STYLE	MAXIMUM OVERALL DIMENSIONS
1 to 51	CC20	A	.200 x .400
	CC21	K	.250 x .562
52 to 110	CC25	B	.200 x .656
	CC26	L	.250 x .812
111 to 360	CC35	C	.265 x 1.125
	CC36	M	.340 x 1.328
361 to 510	CC40	D	.375 x 1.110
511 to 820	CC45	E	.375 x 1.560
821 to 1100	CC45	F	.375 x 2.00

\* CERAMICON IS THE REGISTERED TRADE NAME OF SILVERED CERAMIC CONDENSERS MADE BY ERIE RESISTOR CORPORATION.

Electronics Division

**ERIE RESISTOR CORP., ERIE, PA.**  
LONDON, ENGLAND • • TORONTO, CANADA



BUY MORE WAR BONDS

# SCOVILL PLUGGED A NEW TECHNIQUE

## INTO RADIO TERMINAL JACKS

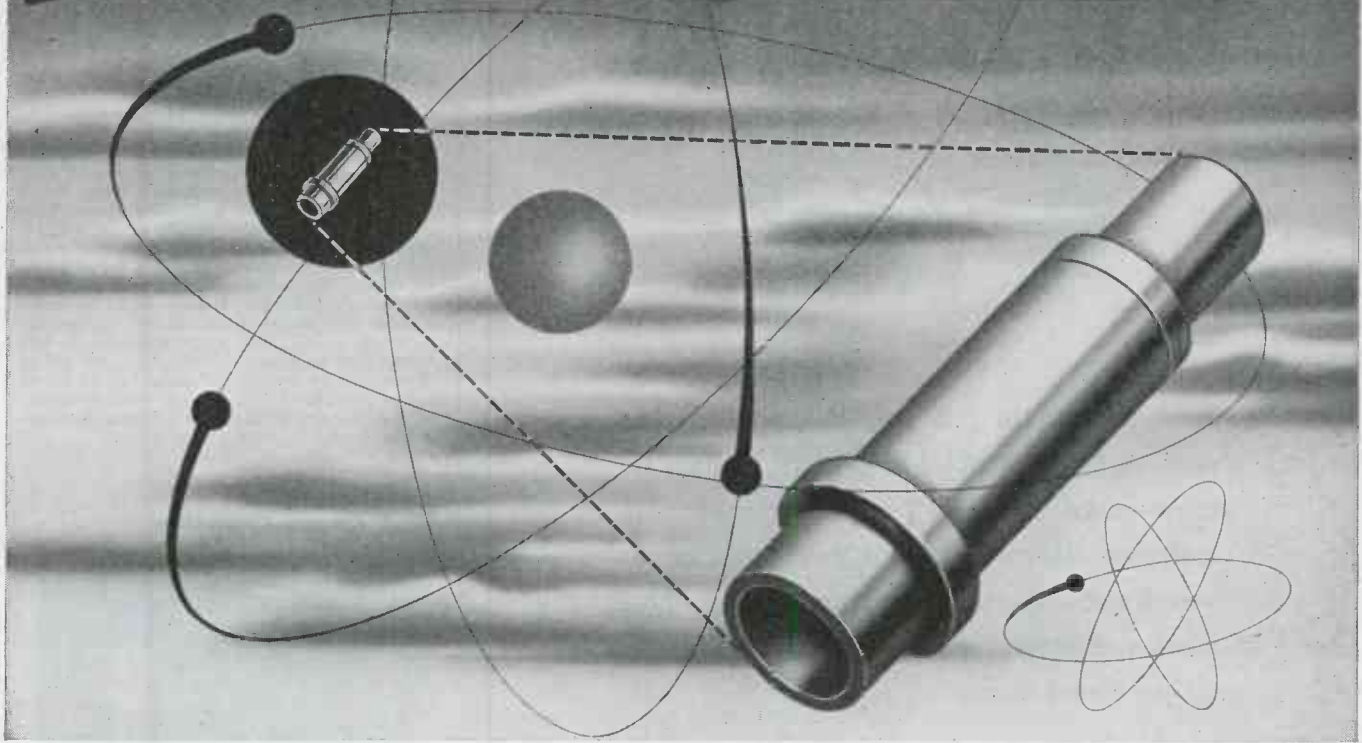

... and disconnected a tie-up



Terminal jacks for war-needed radios — screw-machined from rod stock — were lagging behind other parts. Expeditors called on Scovill to break the bottleneck.

Scovill did just that by shifting to high-speed stamping of sheet metal. This change in technique stepped up production greatly . . . cut down on scrap, always a problem in screw machine operations . . . turned out eminently satisfactory work . . . low-

ered costs by a substantial margin.

Scovill Electrōnents\* may also save time and money for you

Maybe your small electronic components or large assemblies can benefit from Scovill's versatility in forging, drawing, stamping, heading, or machining all kinds of metals and Scovill's impartiality in choosing the one method that will make your Electrōnents\* faster and better for less. For further details of Scovill's designing service and manufacturing

ability, send for literature. Use the coupon below and mail it today.

\*Electrōnents = Electronic Components



Please send me a free copy of "Masters of Metal" booklet describing your facilities. I am interested in the ELECTRONENT\* applications checked.

- |  |                                      |  |
|--|--------------------------------------|--|
| <input type="checkbox"/> Batteries       | <input type="checkbox"/> Dials       | <input type="checkbox"/> Panels            |
| <input type="checkbox"/> Record Changers | <input type="checkbox"/> Escutcheons | <input type="checkbox"/> Sockets           |
| <input type="checkbox"/> Clips           | <input type="checkbox"/> Jacks       | <input type="checkbox"/> Stampings (misc.) |
| <input type="checkbox"/> Condensers      | <input type="checkbox"/> Lugs        | <input type="checkbox"/> Tubes             |

Other applications.....

### SCOVILL MANUFACTURING COMPANY

Electronic Division  
23 Mill Street, Waterbury 91, Connecticut

Name .....

Company .....

Address .....

# IT CAN'T BE DONE!



Time and again this war has proved that *nothing is impossible!* Proved right here in our own backyard, as Temple engineers and craftsmen delve along unblazed trails of research and experiment to design and produce more and better communications equipment for the battle fronts.

This ability to both design and deliver the seemingly impossible, under stress of war, has bred an unfailing inventive capacity that should prove invaluable in meeting the vast commercial requirements of peace.



*Electronics Division*  
**TEMPLE TONE**  
**RADIO MFG. CORP.**  
New London, Conn.



### Frequency—Time Meter

A new electrical indicating instrument combining frequency meter and elapsed time meter in one case is available from J-B-T Instruments, Inc., New Haven, Conn. Frequency or speed are indicated to an accuracy of  $\pm 0.3\%$  by a bank of five reeds calibrated in single cycle steps from 58 to 62 cycles. The running time meter is driven by a synchronous motor, and indicates elapsed time in hours and tenths. Designated as Model 31-FE, this meter operates on 110 volts, and is also available for 48 to 52 cycles and in half cycle steps for 59 to 61 cycles and 49 to 51 cycles, with accuracy of  $\pm 0.2\%$ . Other ranges are under development.

### High Power Capacitor

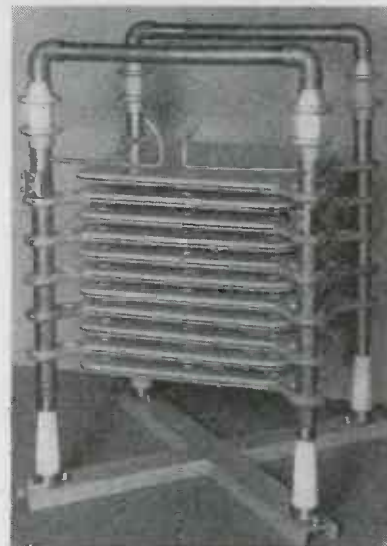

Utilizing a new style of construction, this high power, high capacity condenser has been developed by the E. F. Johnson Co., Waseca, Minn. It is available in various spacing up to  $1\frac{1}{2}$  in. For a spacing of one inch the breakdown rating is 45,000 peak volts at 2 megacycles. The condenser plates are 18 in. square, made of fabricated sheet metal. The frame rods are heavy  $1\frac{1}{8}$  in. copper tubing, and are fitted with heavy strap connectors capable of carrying a high current. A tank coil may be mounted on top of the condenser and supported by the cross pieces. A protective gap is built into the condenser to protect plates in the event flash-over occurs. Top steatite insulators have corona shields. The condenser illustrated has a capacity of 1200 mmf. and stands 40 in. high. Models may be supplied having high and lower capacities at various spacings.

# "BIG THREE" MYCALEX PRODUCTS

Answer Military Needs for Advanced Electronic Insulation...and Afford New and Wide Horizons for Post-war Product Improvement

1

**MYCALEX  
400**



A general purpose insulation, especially fitted for high frequency applications; combines low loss factor with machinability to close tolerances, impermeability to water and oil; not subject to distortion below 700° F. Free of carbonization. Approved by Army and Navy as Grade L-4 insulation. Fabricated to your specifications.

2

**MYCALEX  
K**



A series of improved capacitor dielectrics, with dielectric constant *selectable* from 8 to 15. Available in the form of large sheets (14" x 18"), or long rods 1/4" to 1" in diameter. Low power factor and high dielectric strength. Ideal for use in equipment with variable capacity. MYCALEX K-10 approved by Army and Navy as Grade H1C5H4 Class H material (JAN I-12). Fabricated to your specifications.

3

**MOLDED  
MYCALEX**



A low-loss, high temperature injection molded insulation which can be formed into intricate or irregular shapes, with or without metal electrodes or metal inserts molded in. Adaptable to high production rates and can be sold at moderate prices.



We have plant facilities to fabricate MYCALEX parts to your order. Send for detailed characteristics and specifications of any or all three grades of MYCALEX.

**MYCALEX CORPORATION  
OF AMERICA**

Plant and General  
Offices  
Clifton, N. J.

Executive Offices  
30 Rockefeller Plaza  
New York 20, N. Y.

"OWNERS OF 'MYCALEX' PATENTS"

# Permoflux

# *Triumphs!*



**These "World's Smallest Transformers"  
May Be The Complete Answer to  
Your Space and Weight Problems!**

It's not an everyday occurrence when so large a problem can be answered with such a small unit. In fact, we're mighty proud of this midget transformer achievement—not only for the reason that Permoflux engineers met a vital war challenge, but because of its numerous practical applications. Permoflux welcomes inquiry from design engineers about this midget transformer development.

**BUY WAR BONDS FOR VICTORY!**

TRADE MARK  
**PERMOFLUX**

**PERMOFLUX CORPORATION**  
4900 WEST GRAND AVE., CHICAGO 39, ILL.



**PIONEER MANUFACTURERS OF PERMANENT MAGNET DYNAMIC TRANSDUCERS**

## Walnut Capacitor

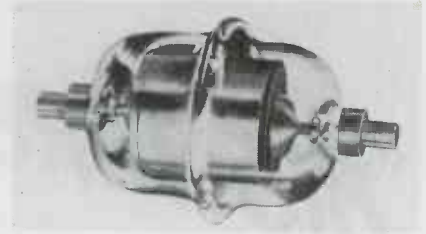

Because of its lightness, compactness, high capacity and economy of operation this new walnut size capacitor is meeting an urgent need in the field of aviation radio. It is also being incorporated in newly designed ground and maritime signal equipment. This small capacitor will operate in ultra high frequency circuits. Its characteristics are: Capacity range 6-50 mfd., maximum voltage 30 kv peak, maximum current 20 amperes peak, self-healing in case of overload. Maker is Jennings Radio Mfg. Co., 1098 East William St., San Jose 12, Calif.

## Accelerometers

A series of accelerometers whose sensitive element consists of unbonded strain sensitive filaments has been developed by Statham Laboratories, 8222 Beverly Blvd., Los Angeles. The filaments are in grid form, and constitute the sole support for the mass. The filaments are connected in a Wheatstone bridge circuit of which all four arms are active. The bridge circuit is balanced in assembly, so that no external balancing circuits or components are required. There are four electrical terminals, one at each corner of the bridge. A small dry cell battery is connected to two of them, and the other two are connected directly to the recording

**BIRD & CO.**  
**GLASS**  
**INSTRUMENT**  
**BEARINGS**

**GLASS "V" BEARINGS**  
*made to your specifications*



*We welcome your inquiries*

**RICHARD H. BIRD**

*Manufacturers of Jewel Bearings  
for thirty years*

**23 MOODY STREET**  
**WALTHAM, MASS.**



# FABRICATORS OF PLASTIC PRODUCTS



A myriad of plastic products from threaded precision parts machined to extremely close tolerances such as those fabricated for Army and Navy aircraft and radios, to transparent plastic card holders, charts, badges and novelties, are produced by SLACO with the same skill and attention to detail. Facilities for Printing, Stamping, Engraving, Embossing, Die Cutting, Molding, Polishing, Forming and Laminating of all plastic materials make possible the production of hundreds of diverse items completely unrelated to each other in character.

SEND US YOUR BLUEPRINTS AND SPECIFICATIONS

## N. G. SLATER CORP

Manufacturers of Plastic and Metal Products

3 WEST 29th ST., NEW YORK 1, N. Y.



### PRECISION PARTS AND PLASTICS FOR EVERY DAY USE

when they offer thee a heifer,  
run with a halter



... and, these days, if and when anyone offers you Macallen Mica, grab it quick. Because Macallen Mica has maintained highest standards of dependability for more than 50 years, it is natural that it should be so generally specified for the machines and instruments of war.



When you think of MICA think of MACALLEN

**the Macallen Company**

16 MACALLEN STREET - BOSTON 27

CHICAGO: 165 W. Washington Blvd.

CLEVELAND: 1001 Lorain St.



galvanometer. The method by which the strain sensitive wires are supported is such that the full efficiency of their strain sensitivity is realized, resulting in an output level so high that no amplification is required. The natural frequencies of these accelerometers vary from 100 to 1000 cycles per second, depending upon their acceleration ranges. The 12 G accelerometer has a natural frequency of 400 cycles per second. The weight of the instrument is two ounces. It is believed by the manufacturer that there is no other comparable accelerometer in existence which will drive standard recording galvanometers without amplifiers or electronic carrier equipment. Statham accelerometers are linear within 1/2%. Their sensitivity to transverse acceleration is less than 0.1%. They cannot be damaged by excessive acceleration. The zero drift with temperature is less than 1% between +100°F. and -50°F. The calibration factor will change less than 3% within this temperature range. For complete details and specifications, address the manufacturer.

#### Bank Type Resistors



Bank type resistors on glazed steatite cores are being supplied by Techtmann Industries, Inc., 828 North Broadway, Milwaukee, Wis., with from 2 to 24 resistors in a bank, six being standard. Individual parts are quickly replaceable.

#### Sealed Resistors



The Shallcross No. 1100 series hermetically sealed accurate fixed wire-wound resistors (Patent Applied for) are constructed without glass, without the use of fragile "floating" or stud-locked resistance elements, and without ferrule terminals or caps. In size, due to the fact that they can be layer wound, they compare favorably with the corresponding standard BX

**NORTH AMERICAN PHILIPS RELIES ON**

# **HEINEMANN** *MAGNETIC* **CIRCUIT BREAKERS**

**For Protection  
Of Medical  
X-Ray and  
Diffraction  
Units**



The North American Philips Company of New York City is taking no chances on what a dangerous overload or short circuit might do to the intricate Medical X-ray and Diffraction Units which they manufacture. Consequently, HEINEMANN MAGNETIC CIRCUIT BREAKERS play an important part in the protection of circuits in these units.

Because the action of these breakers is *entirely magnetic*, the result is instantaneous opening on short circuits, but a time-delay mechanism (acting by means of a plunger which moves in a liquid-filled, hermetically-sealed tube) allows the passage of inrush current and harmless overloads. Continued overload opens the breaker in time inverse to the ratio of the current.

Such protection might be invaluable for YOUR equipment. We suggest that you get in touch with us for further details.

*Send for Catalog Showing Complete Line and Engineering Data*

## **HEINEMANN CIRCUIT BREAKER CO.**

Subsidiary of Heinemann Electric Co., Est. 1888

**137 PLUM STREET**

**TRENTON, N. J.**

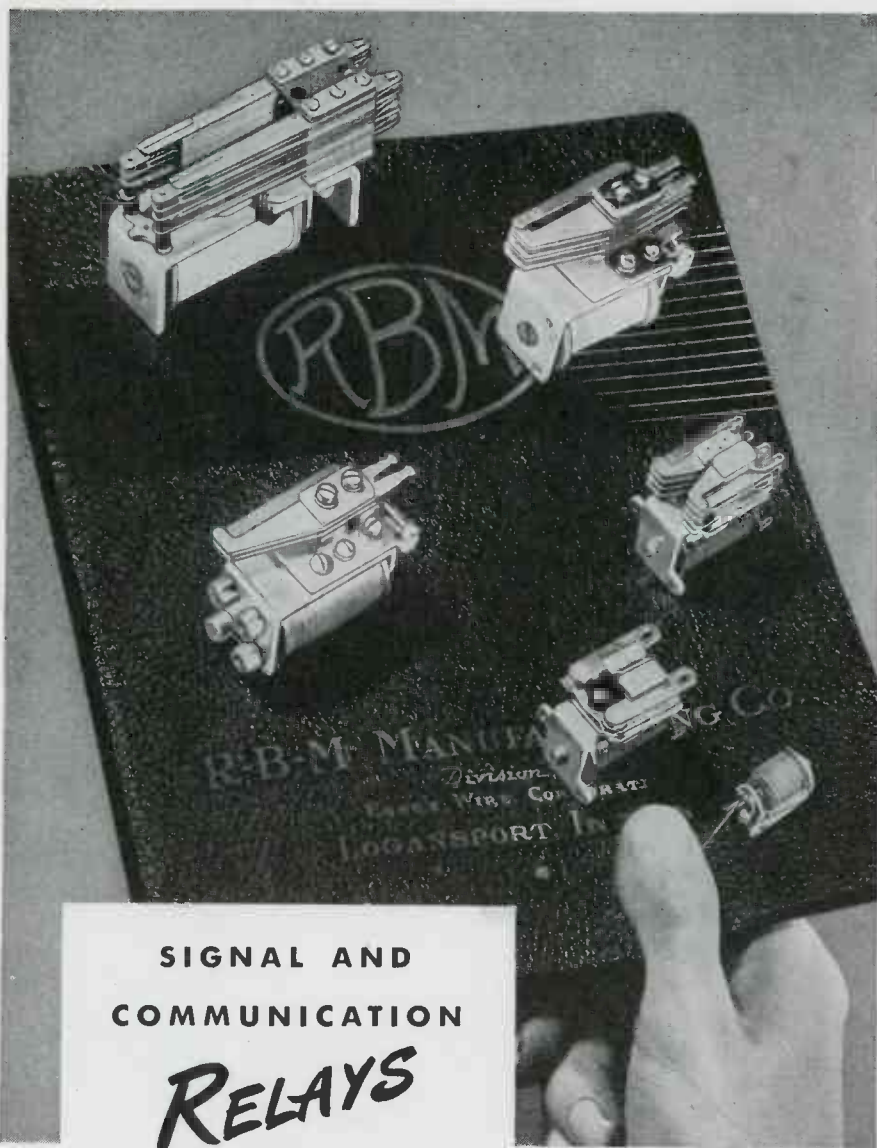

SIGNAL AND  
COMMUNICATION  
**RELAYS**

The extensive R-B-M line includes a wide variety of relays, furnished in complete voltage ranges and contact capacities ordinarily encountered in the signal, electronic, and communication fields. For further information write Dept. B-5 . . .

**R-B-M MANUFACTURING COMPANY**  
Division of  
**ESSEX WIRE CORPORATION**  
LOGANSPORT, INDIANA

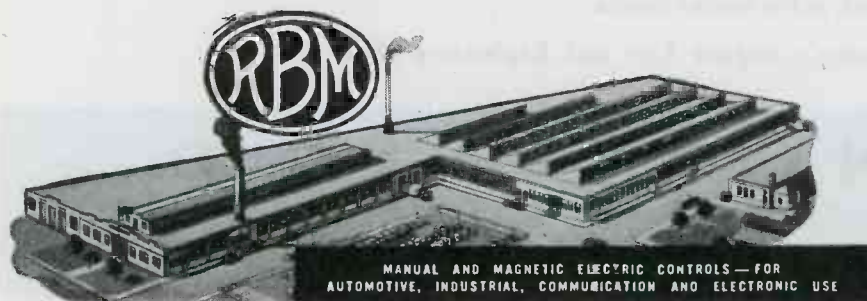

process impregnated Shallcross Types 190 and 196 Akra-Ohm fixed wire wound resistors. They utilize standard mounting facilities and are available in two designs and in all resistance values from 1000 ohms to 10 megohms. High ohmic value non-induction resistances can be enclosed in this type of construction without danger of difficulties due to leakage. Both the resistance form and the protective shell are ceramic. The resistance winding element and outer shell are a complete, integral unit without internal leads or floating wires. Positive solder-sealing without the use of ferrule caps or glass drawing gives absolute protection against moisture.

**High-Voltage Capacitors**

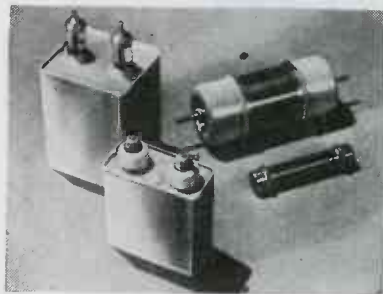

Although extremely compact, Sprague Type 25P capacitors utilizing the Vitamin Q impregnant, operate satisfactorily at thousands of volts at ambient temperatures as high as 105 deg. C. Leakage resistance at room temperature is 20,000 megohms + microfarads, or at least five times higher than that of previous types. Standard types include hermetically sealed rectangular metal container capacitors in styles for 95 deg. C. and 105 deg. C. continuous operation, and in de rated voltages from 1,000 to 16,000 volts.

**ATTENTION:**

- Commercial Broadcasters
- Schools
- Hospitals
- Utility Companies
- Geophysicals
- Transportation Companies
- Marine Operators
- Industrial Plants
- Municipalities
- Radio Dealers
- Radio Servicemen

**AT EASE!**

Everything in radio and electronics from a 1/4 watt resistor to 50,000 watt transmitter (post-war).

Engineering Assistance, too.

Call—Wire—Write.

**Houston Radio Supply Co., Inc.**

910 CALHOUN STREET  
HOUSTON, TEXAS

'Ole Miss Supply Baton Rouge, La.

# LOUD SPEAKER HEADQUARTERS ... MAGNAVOX

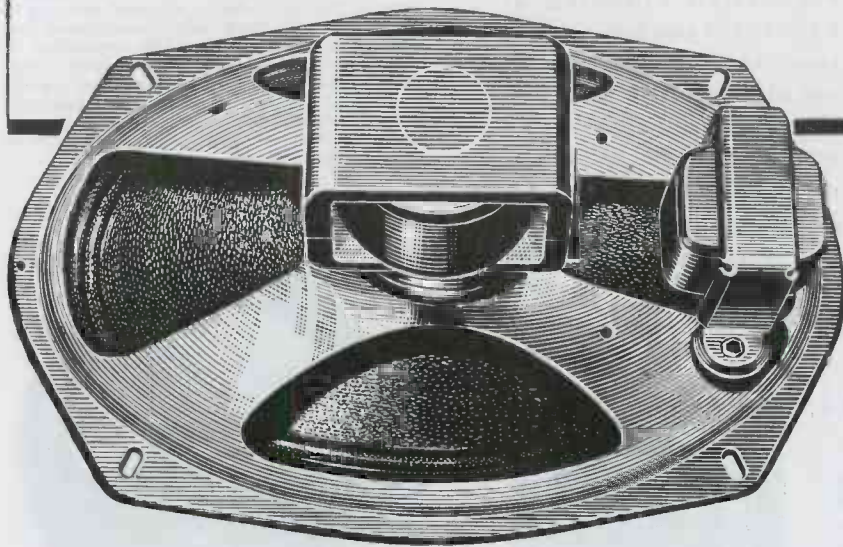

MODEL 69. 118 additional models will be available for the postwar manufacturing trade.

**P**IONEERING in the production of elliptical speakers, Magnavox filled an important need in receivers for automobiles, as well as for larger model home sets and phonograph combinations.

★★ The elliptical speaker offers decided acoustical and mechanical advantages . . . desirable frequency response . . . compensation in the speaker for lack of an adequate baffle . . . ideal directional characteristics and small mounting space.

★★ Because of the wide popularity of the Magnavox elliptical series, various sizes will be available for postwar radios. Electrodynamical or permanent magnet models will be made to your specifications.

★★ In your planning, be sure to consult with loud speaker headquarters.

The Magnavox Company,  
Components Division,  
Fort Wayne 4, Indiana.

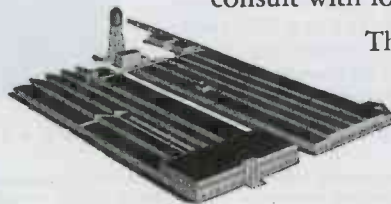

# Magnavox

has served the radio industry 34 years

SPEAKERS · CAPACITORS · SOLENOIDS · ELECTRONIC EQUIPMENT

ELECTRONIC INDUSTRIES • May, 1945

[www.americanradiohistory.com](http://www.americanradiohistory.com)

155

# Comco Production Planning Means

## QUALITY RADIO AND ELECTRONIC EQUIPMENT

# *Customized*

### For the Best in Dependable Performance

Production Planning at COMCO is the point where research and development are synchronized with precision manufacture and scientific assembly. The result: a product of fine quality and superior operating characteristics, *customized* to meet the most exacting requirements.

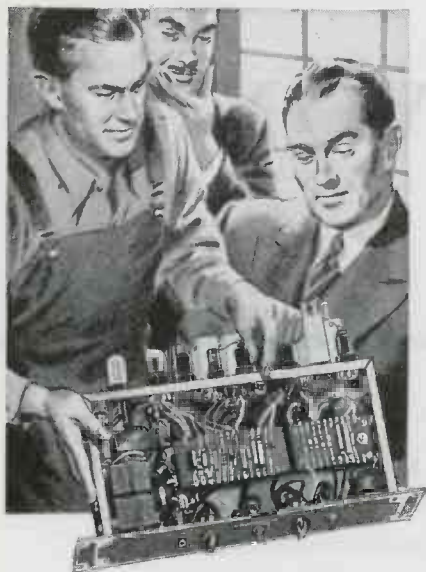

#### COMCO TRANSMITTER Model 127 AA

15 watts output. Frequency range 200 to 550 kc. Cabinet size: Width 23"; Depth 18"; Height 48". Other COMCO Transmitters available for operation on VHF and medium high frequencies.



#### COMCO RECEIVER Model 82F

Fixed tuned, single frequency, crystal controlled, superheterodyne, radio telephone receiver. Frequency range 2 to 8 Mc. Standard 3½" rack panel mounting Eight tubes. Other COMCO Receivers available for operation on VHF and low frequencies.



WRITE! Just a note on your company letterhead outlining your exact requirements. We'll give you the benefit of our specialized experience. We can supply a wide variety of customized equipment on priority NOW. We are accepting non-priority orders for post-war delivery.

MANUFACTURERS OF RADIO & ELECTRONIC EQUIPMENT



# COMMUNICATIONS COMPANY, Inc.

CORAL GABLES 34, FLORIDA

### Dynamic Microphone



The new D20 Series microphone offered by the Universal Microphone Co. of Inglewood, Cal., has an extended frequency range and conventional dynamic response characteristic. Mounted on substantial "Micro-Adjust Swivel," the unit may be positioned anywhere throughout a 60-degree angle without disturbing the balance or appearance of the microphone. Internal element is mechanically isolated, minimizing stand and cord noises. Built-in cable connector is easily accessible without interference with microphone. Unaffected by weather conditions and vibration. Designed for use both indoors and outdoors with frequency range of 50 to 8000 cycles at —54 db as referred to one volt per bar.

### Miniature Meter



A hermetically sealed, ring-mounted miniature 1½ in. meter, Model 120, has been developed by the DeJur-Amsco Corp. at Northern Blvd. and 45th St., Long Island City 1, N. Y. The case including the terminal studs is completely waterproof; thus, if the glass breaks, the equipment remains waterproof. Built of corrosion resistant materials, the meter has a black anodized finish. The instrument flange may be mounted on any thickness panel between ⅛ and ¼ in. steel or bakelite. A waterproof gasket is supplied. The meter is ring-mounted and is available in a wide variety of ranges including microammeter or microvoltmeter.

### Low Temperature Plasticizer

Commercial scale production of a new ester type plasticizer which imparts a high degree of flexibility to vinyl coated fabrics subjected to low temperatures such as those used in strip coatings, free films, and insulation jackets, has been developed by the Resinous Products & Chemical Co., Philadelphia. Dioctyl Sebacate is a high boiling, stable, light colored liquid and combines the excellent low temperature flexibility associated with dibutyl sebacate with the extreme non-volatility characteristics exhibited by dibenzyl sebacate. The plasticizing efficiency (100 percent modulus) of Dioctyl Sebacate is intermediate between that of dibutyl sebacate and dioctyl phthalate.

**FOOL-PROOF! THAT'S THE G. I. POST WAR RECORD CHANGERS!**



One simple fact must never be overlooked: Even the most beautifully engineered record changer is home equipment. As such it has to be proof against little Willie, a saboteur at heart, Uncle Bill who is all thumbs and Aunt Edna who just loves music but is just plumb careless.

For years our G. I. pre-war changers have been working overtime. Their overall record of trouble-free performance in the face of parts shortages and

lack of repair help has been nothing short of amazing. That's the dealers' opinion.

Now G. I.'s Post War Record Changer is all set and ready to go. The set manufacturers we've permitted to peek under the lid are enthusiastic beyond words. The operating simplicity that has been achieved—its functional streamlining—its fool-proof operation—will make history in this industry.

# GENERAL INSTRUMENT CORPORATION



829 NEWARK AVENUE • ELIZABETH 3, N. J.

# Deep is the magic of SOUND



The magic of sound has been the business of Webster Electric for many years.

Our engineers have applied their talents to the building of Webster Electric Pickups of just the right balance, the right pressure and of just the proper materials to reproduce sound with the utmost fidelity.

Today this engineering and manufacturing skill of Webster Electric is being devoted to bringing victory closer.

In the course of these herculean efforts to develop more and better products for war and to build them in greater quantity, we have learned important things... have made discoveries that will make Webster Electric Pickups more than ever capable of giving you the clear, high quality tone reproduction you have learned to expect from Webster Electric products.

As you develop fine new products for post-war markets, you will want to know more about what Webster Electric has in store for you. We invite you to keep in touch with our laboratories and our engineers in order that you may be ready with the finest in tone reproduction.

Let's All Back the Attack  
Buy Extra War Bonds



(Licensed under  
patents of the  
Brush Development  
Company)

# WEBSTER ELECTRIC

Racine, Wisconsin, U.S.A. • Established 1909 • Export Dept.: 12 E. 40th Street, New York (16), N.Y. Cable Address "ARLAB" New York City

"Where Quality is a Responsibility and Fair Dealing an Obligation"



## Instrument Knob

The General Cement Mfg. Co., Rockford, Ill., has available a new type knob for communication equipment, instruments, etc. It is smooth finished molded bakelite with pointer arrow on front. 1 1/4 in. O D x 3/8 in. over-all height.

## Luminous Characters

An addition to an inlay process for placing durable characters on metal panels, chassis, etc., has been put out by Screen-makers, 64 Fulton Street, New York 7, N. Y. These inlaid baked enamel characters, protected by background finish, are now obtainable, if desired, completely luminous, either phosphorescent or fluorescent. They are resistant to abrasion and salt spray.

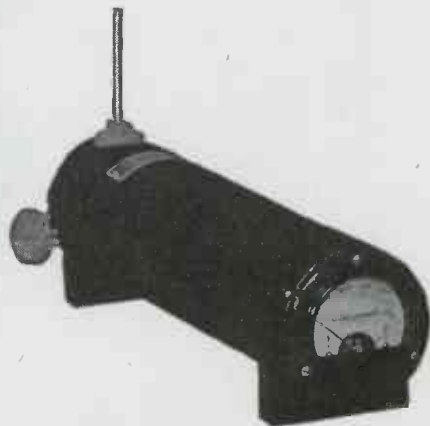

## Resonance Meter

A new resonance meter (Type MW-70) has been developed by Erco Radio Laboratories, Inc., Hempstead, New York. The instrument is designed around a high Q concentric resonant chamber whose center conductor is made variable through the use of a rack and spur gear. A small plug-in pick-up antenna is optimum coupled to the center conductor. Rectification is obtained with a miniature crystal cartridge and indication of resonance is directly shown on a dc microammeter which is mounted in the end of the housing.

## Regulated Power Supply



A compact, light-weight, many-purpose rectifier unit for use in a wide variety of applications where closely regulated direct-current is required has recently been developed by the Federal Telephone and Radio Corp., Newark, N. J. The unit utilizes the Federal selenium rectifier and operates from a single, phase ac input of 115 volts, 58 to 62 cycles, providing dc power up to 10 amperes, continuous duty, at any selected volt-



# Another IN-RES-CO scoop!

## MOISTURE AND FUNGUS PROOF HERMETICALLY-SEALED RESISTORS for long life, stability and reduced maintenance



### TYPE BX

1 watt maximum; 30,000 ohm max. (Manganin); 1 MEG. max. (Nichrome); 1-5/16" long, 9/16" diameter; supplied with 2" # 18 copper leads.



### TYPE SX

1 watt maximum; 1 MEG. max. (Nichrome); 30,000 ohms max. (Manganin); 1-5/16" long, 3/8" diameter; overall length 2-1/16" including 8/32 studs.



### TYPE WX

2 watts maximum; 1 MEG. max. (Nichrome); 0.5 MEG. max. (Manganin); 1 1/2" long, 7/8" diameter; overall length 2 1/4" including 8/32 threaded studs.



**Sealed hot to evacuate  
all air and moisture!**

Four new types of IN-RES-CO hermetically-sealed resistors, now in production, meet a multiplicity of electronic and electrical equipment requirements. Featuring absolute immunity to fungus, moisture and corrosive fumes — free from noise frequently introduced by electrolysis and leakage — each is enclosed in molded bakelite.

An important factor is the sealing-in process, consisting of wax impreg-

nation and oven dehydration, which excludes all possibility of "trapped" moisture or air. Circuit instability and premature breakdown caused by resistor failure are eliminated.

IN-RES-CO Hermetically Sealed Moisture and Fungus Proof Resistors are applicable for all installations — mobile, airborne or tropical — where deteriorating influences are present. Inquiries are invited.

### CHECK THESE ADVANTAGES:

- Mechanical protection is provided by rugged, sturdy, telescope-type molded bakelite case which is moisture and fungus proofed.
- Resistor element is impregnated with a moisture and fungus proof high temperature compound and then oven dehydrated prior to sealing.
- Mounting — Types RX, SX, and WX have 8-32 threaded studs and two hex. nuts each end.
- Construction — Ceramic spools are non-hygroscopic, leakage and electrolysis effects are eliminated. Nichrome, Advance or Manganin windings are available.
- Accuracy — standard tolerance is 1%; accuracy to 1/10 percent at additional cost. Slight additional cost for Manganin or Advance wound units.



**INSTRUMENT RESISTORS COMPANY**  
29 AMITY STREET, LITTLE FALLS, NEW JERSEY

SUITABLE FOR  
A DIVERSITY OF  
MOUNTINGS



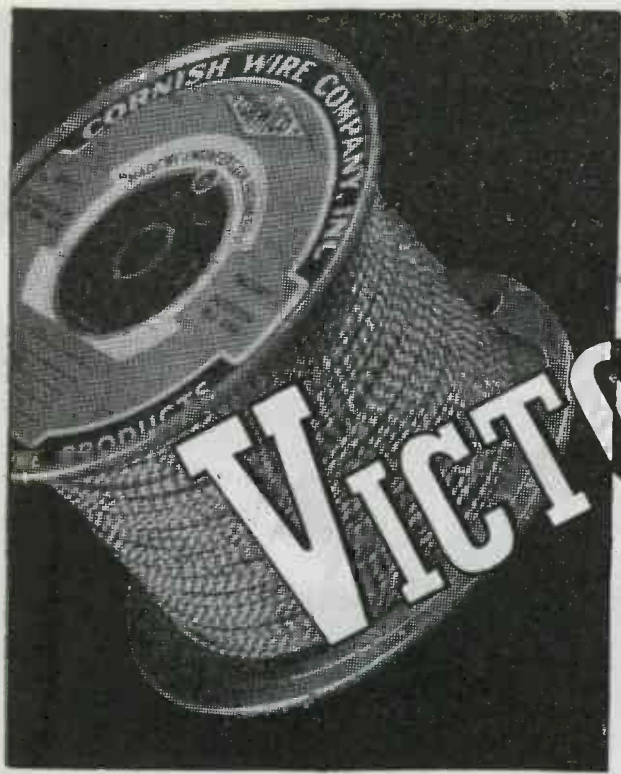

**VICTORY**

is so

**Exacting**

**A**FTER the last enemy lays down his arms . . . then must follow the fabulous changeover whereby industry diverts production for War into production for Peace.

A critical and an exacting phase!

We at CORWICO are already planning for the transition. Soon millions of tons of basic materials formerly required by our armed forces can be diverted to peacetime uses . . . including, you may be sure, the fine CORWICO Wires that civilians have so patiently gone without for so long.

**cornish**

**WIRE COMPANY, INC.**

15 Park Row, New York City, New York



*"Made by Engineers for Engineers"*

age between 22 and 30 volts. Output voltage is automatically held constant within + or - 0.5 volt regardless of load variation from zero to 10 amperes, or ac line voltage fluctuations of 105 to 125 volts. Ripple voltage is limited to approximately 5%.

**Internal Gager**



The new model N-5 internal measuring instrument produced by the Sheffield Corp., Dayton, Ohio, embodies both mechanical and electrical principles and is a comparator type instrument for the precision measuring of internal dimensions, equipped with an electric gaging head known as the Electrigage, an improved amplifying device (2500 to 1) developed jointly by research engineers of Sheffield and Westinghouse. Gaging range includes minimum and maximum gaging diameters of .370 and 12 in., respectively. The surface plate is adjustable vertically, giving a gaging from the surface plate to center of diamond points of 1/8 in. to 1 1/2 in. depth of the hold may be checked. It is possible to explore a hole 3 in. deep throughout for diameter, taper, bell mouth, and out-of-round conditions. Capacity is sufficient to accommodate an A.G.D. ring of the largest size. The instrument can also be supplied with special gaging arms for checking holes down to and including .240 in. in diameter. The maximum gaging depth from the surface plate to center of diamond points on these arms is one inch.

**Low-Loss Plastic**

Bakelite Corp., 300 Madison Ave., New York, has brought out a new low-loss phenolic plastic molding material, designed specifically to provide stable electrical insulation values even under conditions of elevated temperature and high relative humidity. Designated as BM-16981, this phenolic, mica-filled molding material is especially suitable in high-frequency circuits where the loss factor must be held to a minimum under a wide range of operating conditions. In a recent test specimens molded of BM-16981 and various other mica-filled phenolic materials were immersed for a period of 3,600 hours in water heated to 50 deg. C. The volume resistivity of BM-16981 remained high, decreasing from  $1 \times 10^8$  megohms to  $1.6 \times 10^5$  megohms. At 1 megacycle, the power factor of BM-16981 was 0.055. In addition to this characteristic, BM-16981 possesses the following properties: Specific gravity—1.86-1.92; molding shrinkage—0.002-0.004 in. per in.; izod impact strength—0.30 to 0.34 ft.-lb. per in. of notch—A.S.T.M.D-48-43-T; flexural strength—9,000-11,000 lb. per sq. in.—D-48-43-T; compressive strength—18,000-24,000 lb. per sq. in.—1/2 in. cube; power factor, 1 kc—0.010-0.015—A.S.T.M.-D-48-43-T; power factor, 1 mc—0.0065-0.075—A.S.T.M.-D-48-43-T; water absorption—max. gain in weight—0.05 per cent—A.S.T.M.-D-48-43-T.

VERI  
GRAIL

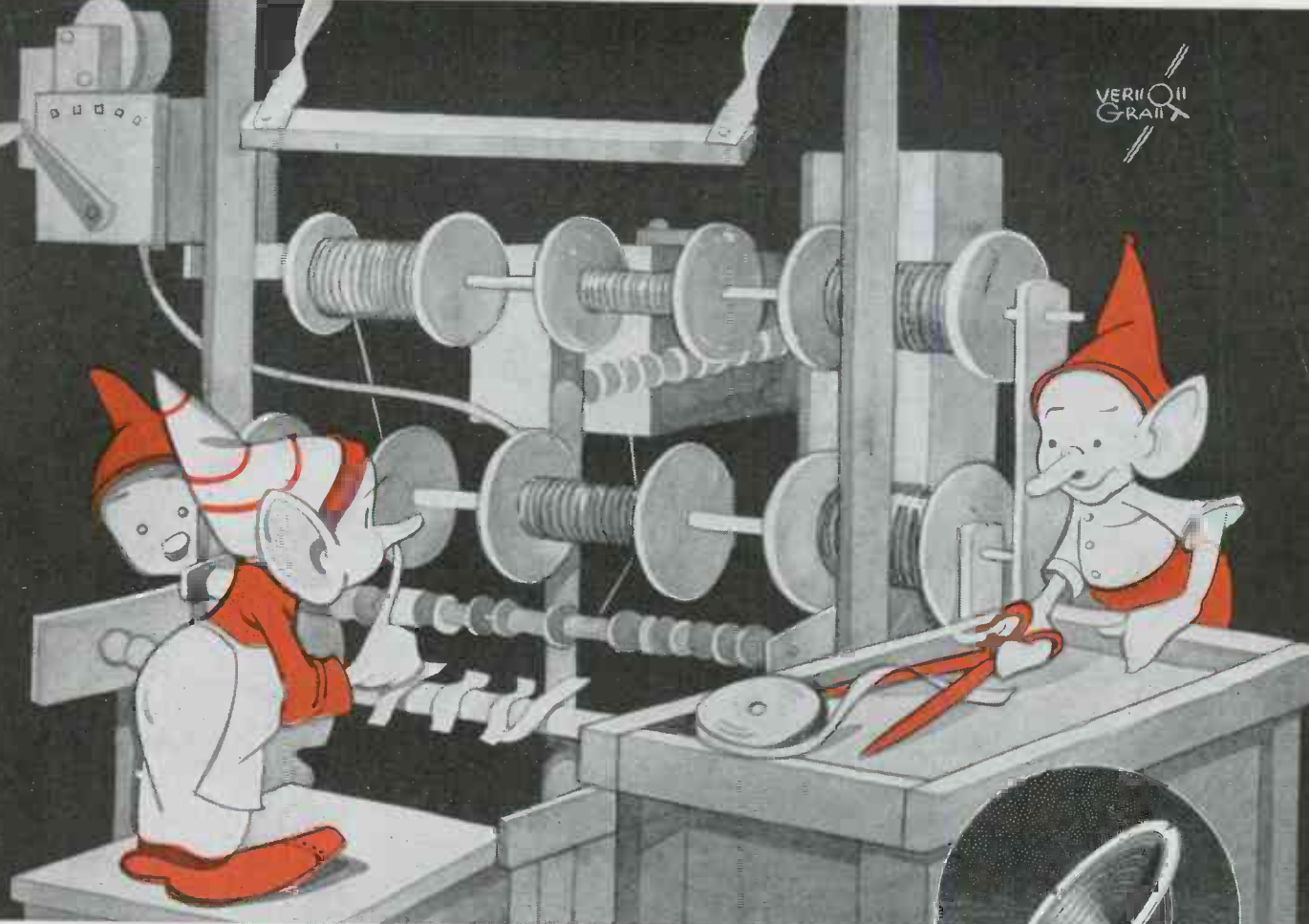

★ *Utah Speakers: More than 20 million Utah speakers have been made for radio, and public address systems.*

## **PRECISION PLUS... THAT'S UTAH PERFORMANCE**

When it comes to coil winding, Utalins\* are past masters. They operate machines, built by Utah engineers, that produce finished products to a greater accuracy than ever possible by human hands alone.

This, and every manufacturing step, is part of a comprehensive process carried

through in Utah's own factory . . . tooling, welding, plating, winding . . . to unexcelled standards of accuracy. Then comes checking, rechecking, supervising, testing . . . till every step of production has been thoroughly approved. In fact, there's not one moment from the original buying of raw materials to the final delivery, that Utalins\* relax their efforts. This is the Utah perfection that guarantees performance.

\*Utah's Helpers



**UTAH RADIO PRODUCTS COMPANY, 820 ORLEANS ST., CHICAGO 10, ILL.**

*Utah Electronics (Canada) Ltd., 300 Chambly Road, Longueuil, Montreal (23) P.Q. • Ucoa Radio, S.A., Misiones 48, Buenos Aires*

# "AIR SUPREMACY"



"Control of the air" today means more than massed firepower and numerical dominance by aircraft; it means control of communication channels . . . and better detecting devices—better directional finders—better protective equipment. The air today is filled with high-frequency impulses, activated by radio and radar. And helping assure that supremacy are Delco Radio products, ranging from compact mobile radio sets in combat vehicles, planes and ships, to highly intricate electronic equipment. They represent the effective combination of engineering vision and manufacturing precision that safeguards the performance of all Delco Radio equipment, wherever it serves and whatever its purpose. Delco Radio Division, General Motors Corporation, Kokomo, Indiana.

KEEP BUYING  
WAR BONDS

**Delco Radio**  
DIVISION OF  
**GENERAL MOTORS**

# IDEAS + ENGINEERING

The ideas that will permit the successful development of your electrical equipment requiring the use of metallic rectifiers have perhaps already been developed by B-L engineers.

The Benwood Linze Company has pioneered in developing the application of dry plate metallic rectifiers wherever Direct Current is required from an Alternating Current source. The B-L Research Laboratories, established since 1921, have become an internationally recognized source for information in this specialized field.

Dry plate metallic rectifiers are an important electrical specialty. Many prominent, successful engineers—men who understand intimately most phases of electricity—have today, simply through unfamiliarity, only a limited knowledge of the wide variety of possible applications for rectifiers.

B-L engineering experience—in the development, research and designing of equipment for the conversion of AC to DC—is available to your technical staffs as an aid in meeting their production requirements.

We invite your inquiries—address Dept. B.

SELENIUM



COPPER  
SULPHIDE

## THE BENWOOD LINZE COMPANY

Long Distance Telephone Central 5830

1815 Locust Street • • • St. Louis 3, Mo.

New York Sales Office:  
Murray Hill 5-5878  
420 Lexington Ave.  
New York 17, N. Y.

Chicago Sales Office:  
Telephone Central 2379  
20 N. Wacker Drive  
Chicago 6, Illinois

DESIGNERS AND MANUFACTURERS OF SELENIUM AND COPPER  
SULPHIDE RECTIFIERS, BATTERY CHARGERS, AND D. C. POWER  
SUPPLIES FOR PRACTICALLY EVERY REQUIREMENT.

# CRYSTAL BLANKS

to Your

*Specifications*

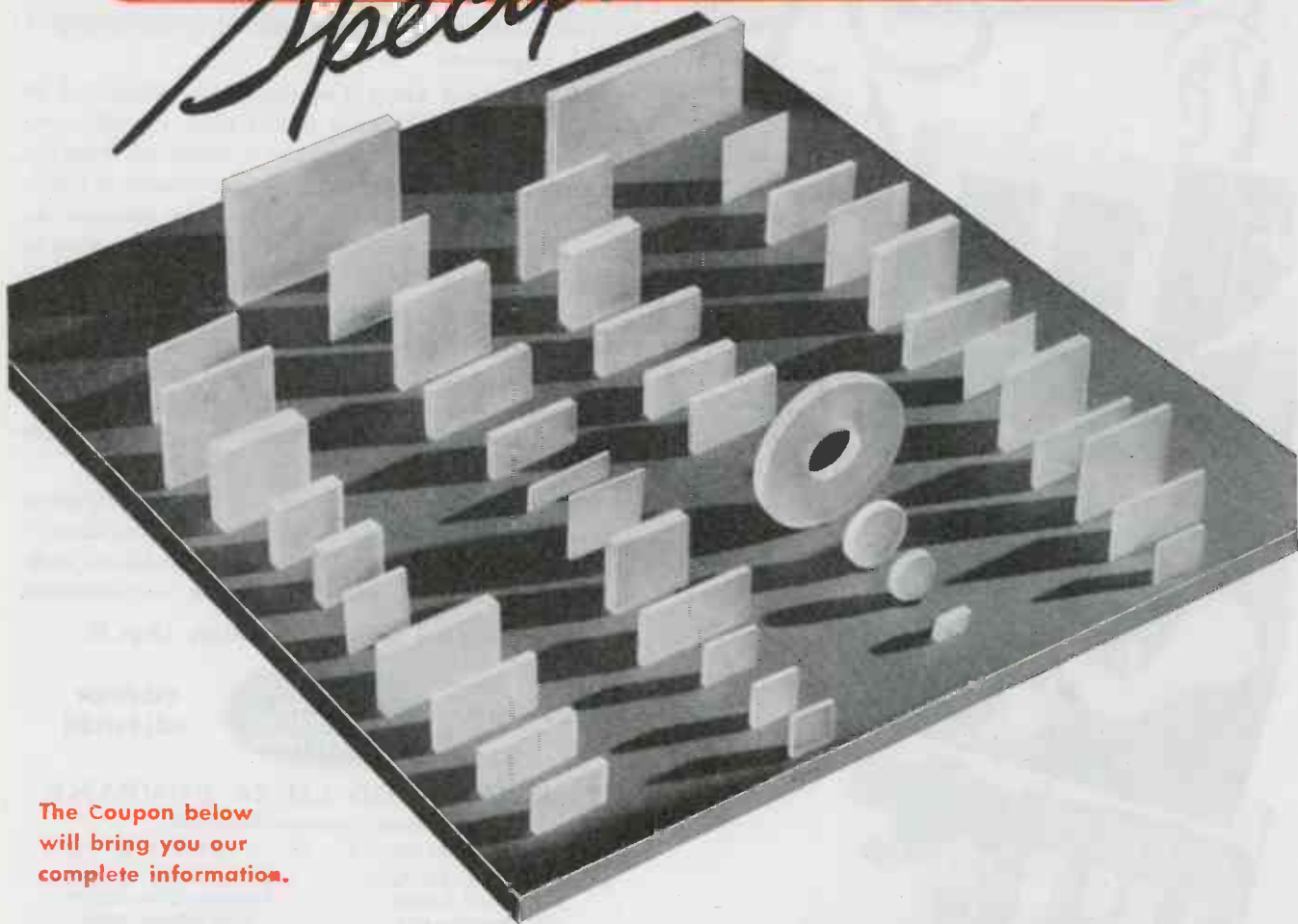

The Coupon below will bring you our complete information.

Our crystal blanks are cut to specifications from selected Brazilian quartz and guaranteed free from all impurities, mechanical and electrical imperfections. Dimensions, temperature coefficients and frequencies

are guaranteed within your specifications. Supplied in either "rough-sawed", "semi-finished" or "electrically-finished" blanks as desired. Remember Crystal Products when you need crystals.

MAIL THIS COUPON!

CRYSTAL PRODUCTS CO.,  
Dept. O, 1519 McGee, Kansas City, Mo.  
Gentlemen: I am interested in

NAME \_\_\_\_\_

FIRM \_\_\_\_\_

ADDRESS \_\_\_\_\_

CITY \_\_\_\_\_ STATE \_\_\_\_\_

  
CRYSTAL

PRODUCTS COMPANY

1519 MCGEE STREET KANSAS CITY, MISSOURI

Producers of Approved  
Precision Crystals for Radio Frequency Control



"HE WAN'STA KNOW  
WHY THEY CALL THIS  
THA' PACIFIC  
THEAYTER"

WHAM!

SWISH

ZING



*Fine instruments produced in volume with precision first . . . . to last.*

# Triplett



**ELECTRICAL INSTRUMENT CO.**  
BLUFFTON, OHIO

# MEET THIS NEWEST MEMBER OF THE FREED TRANSFORMER FAMILY

NO. 4 IN A SERIES



## A MULTI-CHANNEL FILTER

*for frequency selection in remote control systems!*

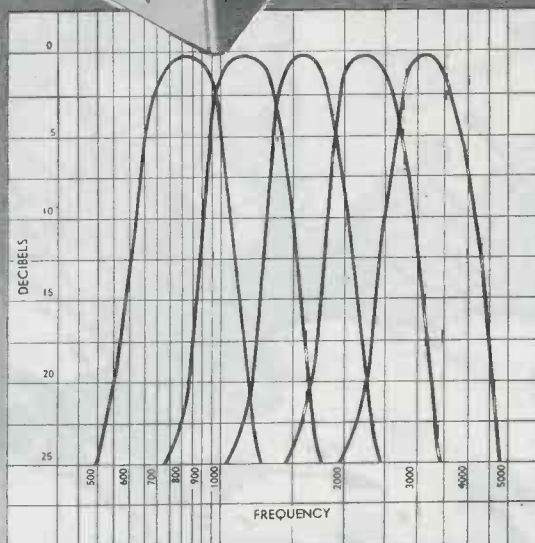

This new unit developed by Freed is a great forward step in filters for frequency selective remote control systems. Consisting of five band pass filters having their inputs in parallel and five separate outputs, this multi-channel filter incorporates **FOUR** outstanding features: 1. Unusually broad pass band and high attenuation at the adjacent channels; 2. Electrical stability that permits its use under the most adverse service conditions; 3. Power handling capability which makes possible the use of a rectifier and relay directly in the output of the filter; 4. Hermetically sealed and ruggedly constructed for long life and durability. Here is another example of Freed pioneering . . . another reason why engineers say: "LOOK TO FREED FOR THE FINEST."

*For transformers, reactors, filters for your postwar products, consult Freed Engineering Service now. Descriptive folder on request.*

# FREED TRANSFORMERS

FREED TRANSFORMER COMPANY  
74 SPRING STREET, NEW YORK, CITY

## Philips Terminates Patents in U. S. After July 1

The Hartford National Bank and Trust Co., as trustee under an indenture dated August 25, 1939, with N. V. Philips' Gloeilampenfabrieken (Philips Incandescent Lamp Works Co.) of Eindhoven, Holland, has announced that on July 1, 1945, all licenses issued by the Radio Corp. of America under the United States patents of Philips will terminate.

These important patent rights have flowed to American industry for the last twenty years through license agreements (now terminated) with RCA, General Electric Co. and Westinghouse Electric and Mfg. Co. Licenses under these patents were also included in the license granted by the RCA to the Government for war purposes. Practically all major radio communications equipment today incorporates principles covered by Philips patents.

The trustee is taking steps to make the patent rights available to the Government and industry under appropriate terms after the present licenses expire. RCA, General Electric and Westinghouse will continue to hold non-exclusive licenses after July 1 under existing patents. It is also planned that future United States patents on inventions of Philips scientists will be made available to the industry.

Philips Incandescent Lamp Works Company, organized in 1891, has long been one of the world's leading manufacturers in the field of radio, lighting, X-ray and other electrical and electronic products. Before the war it employed throughout the world more than 45,000 persons.

## Trav-Ler Karenola Moves

Trav-Ler Karenola Radio and Television Corp. has established general offices, showrooms and research laboratory in a new four-story building at 571 West Jackson Boulevard, Chicago. Manufacturing will be continued at the company's Orleans (Ind.) plant, which eventually will be supplemented by another in Bedford, Indiana.

## Dresser in New York

Dresser Industries, Inc., has opened consolidated offices at 800 Chanin Building in New York. Sales departments of Dresser member companies represented in the new headquarters include Dresser Mfg. Division, Bryant Heater Co., Clark Bros. Co., Inc., Pacific Pumps, Inc., International Derrick and Equipment Co., Roots-Conner Blower Corp., and Stacey Bros. Gas Construction Co.



# what you should know about

# STYRALOY

## Dow's new plastic for electrical applications

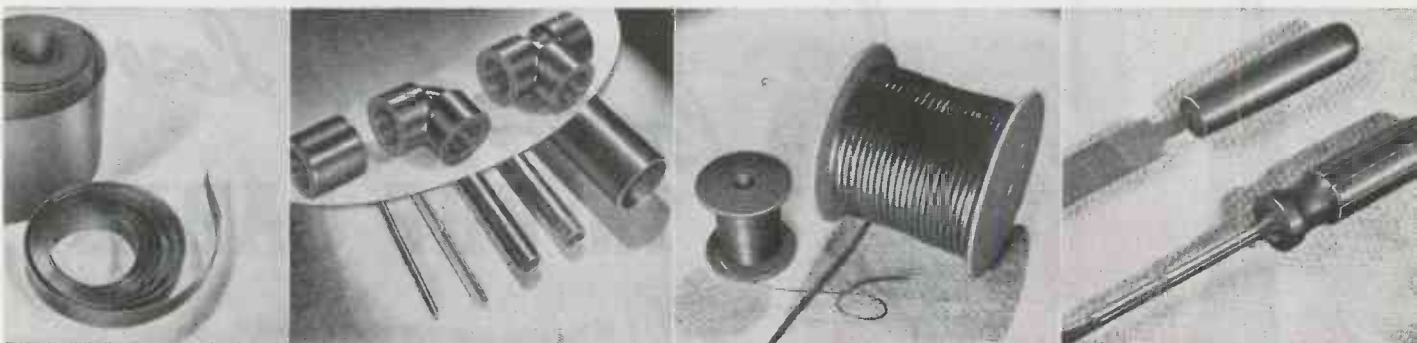

Enthusiastic response from many electrical engineers followed the recent announcement of Styraloy 22. Such special interest is well-founded for this new, Dow developed synthetic elastomer already occupies an important place in the field of low-loss, low capacitance, high dielectric strength, insulating material.

Developed initially for insulation uses where low loss at high frequency was an important factor, Styraloy 22 soon attracted attention for other uses . . . for aircraft ignition installations because of its flexibility at low temperatures and freedom from corona attack even at high altitudes . . . for radio gaskets, bushings, and similar products . . . for combining with synthetic rubber to provide flexible, water resistant wire insulation.

These are some of the things you should know about Styraloy 22—so you can determine where this new product can best fit into your own plans. Complete data is available on request.

*Let's work it out together*

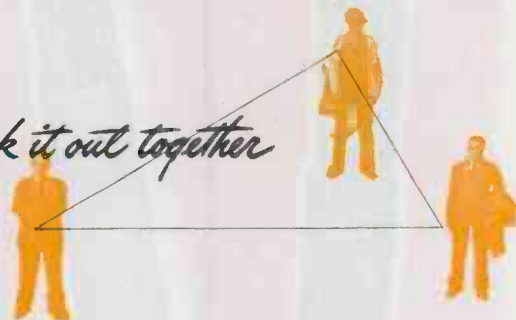

We at Dow know from experience that success in plastics is not a one-man nor even a one-industry job. It calls for the combined skill and cooperation of manufacturer or designer, plus fabricator, plus raw materials producer. Working together, this team saves time and money and puts plastics to work successfully. Call us—we'll do our part.

**PRESENT AND POTENTIAL USES:** One-piece cable sheathing; handles for tools, household appliances, etc.; gaskets; bushings; coil forms; floor mats; scuff plates; many applications still to be ascertained.

**PROPERTIES AND ADVANTAGES:** High dielectric strength, low power loss. Power factor only .005 at 100-300 megacycles. Flexible and shock resistant from  $-90^{\circ}$  F. to  $212^{\circ}$  F. Specific gravity less than 1 (floats on water). Water absorption only .2 to .5%. Resists heat, ozone, and most chemicals. Highly resistant to abrasion. Resists permanent indentation. Ideally suited to extrusion of complex cross sections and readily fabricated by other molding techniques. Easily machined.

**THE DOW CHEMICAL COMPANY • MIDLAND, MICHIGAN**

New York • Boston • Philadelphia • Washington • Cleveland • Detroit  
Chicago • St. Louis • Houston • San Francisco • Los Angeles • Seattle

**DOW**  
**PLASTICS**

STYRON • ETHOCEL • ETHOCEL SHEETING  
SARAN • SARAN FILM • STRIPCOAT • STYRALOY

**ELECTRONICS**

# DESIGNERS'

**How G.E.'s  
High-sensitivity Tests**

*Lowered the Losses*  
**IN UHF CABLE**

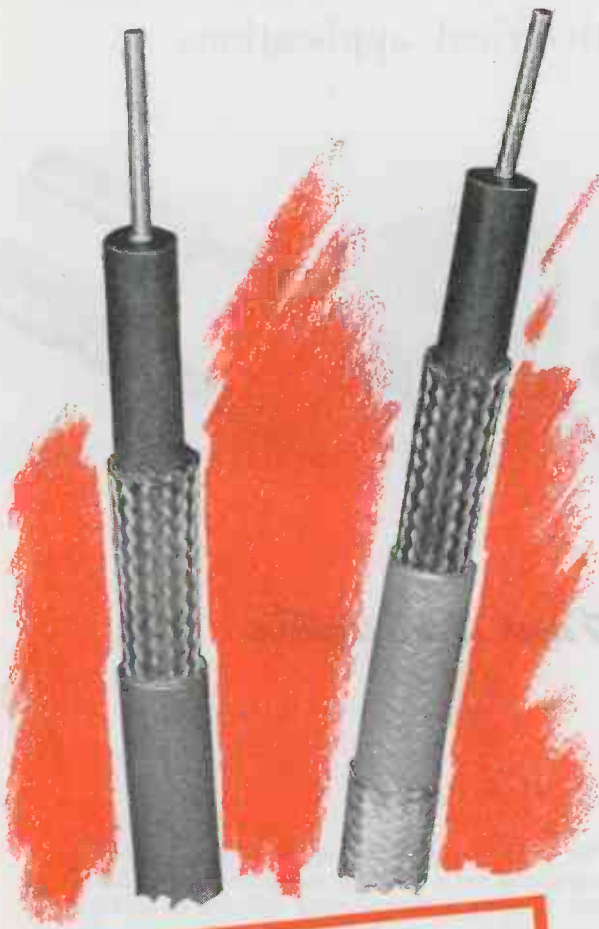

Early in 1940, G-E engineers began completely new investigations into the production of urgently needed UHF cable, with a view to producing better cable faster.

They knew, from experience, that slight changes in braid pattern made large variations in losses, and they were determined to find the one best pattern for each type of UHF cable. Using high-sensitivity instruments and other laboratory facilities that were unmatched at that time by any other manufacturer, they studied the effects of width of strand, the weaving angle, and the spacing between strands. After hundreds of tests, concentric-braid patterns which gave the lowest losses were devised.

But braid pattern was just one of the problems. There was also the influence of the dielectric material. Our engineers found that the presence of the slightest impurity, or even minor physical variations in the extrusion process, boosted the losses. Here again, it was G-E experience—gained in the extrusion of similar compounds—that led to the solution of the problem.

Similarly, the remaining problems involved in both design and production were solved. Today, G.E. offers a complete line of UHF cable to meet numerous exacting requirements. Details are available from our nearest office.

Whether you are designing new electronic equipment for television or for war weapons, you can't find a better starting point than G-E' ultra-high-frequency cable. *General Electric, Schenectady, N. Y.*

Buy all the BONDS you can  
—and keep all you buy

General Electric Company, Sec. 642-5,  
Schenectady 5, N. Y.

*Yes,* please send me

..... GEA-3911 (on Formex wire)

..... GEA-36344 (on voltage stabilizers)

NAME .....

COMPANY .....

ADDRESS .....

642-5

**GENERAL  ELECTRIC**

# DIGEST

## FORMEX MAGNET WIRE

Round or Ribbon—

**Ultra Thin**

Where your new product designs put a premium on space you'll find the ideal magnet wire for your difficult coil-winding jobs in G-E Formex.\* In "ribbon thin" rectangular shape, or in round cross sections "mikeing" less than a strand of human hair, this tough, strongly insulated wire enables you to wind more compact, more rigid coils.

G-E Formex ribbon-rectangular magnet wire is available from four mils up to nine and one-half mils in thickness.

Round Formex is available in standard sizes from 8 Awg to 40 Awg, and in ultrafine sizes from 41 Awg down to one circular mil in copper area.

Write now for full information on sizes, shapes, and recommendations for baking procedure and bonding agents. Ask for Bulletin GEA-3911.

## To Keep Voltage ON THE BEAM



This G-E automatic voltage stabilizer is used with equipment that requires closely regulated input voltage. Changes of input potential or the effects of uneven load are corrected immediately. There are no moving parts—no adjustments are required. Ask for Bulletin GEA-3634A.

\*Trade-mark Reg. U. S. Pat. Off.

## TIMELY HIGHLIGHTS ON G-E COMPONENTS



Capacitors • Sensitive control and time-delay relays • Limit switches • Motors, dynamotors, amplidyne • Motor-generator sets • Alnico magnets • Small panel instruments • Formex magnet wire • Radio transformers • Switchettes • Selsyns • Chokes • also tubes, crystals, plastics products, insulation materials, and many others



# AMPHENOL HOOKS 'EM UP

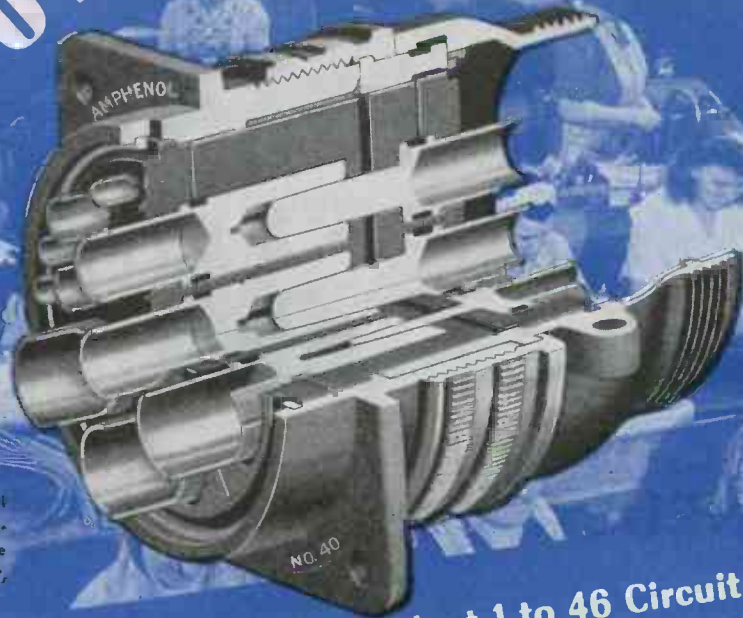

Enlargement of an actual photograph of an A-N Connector sawed in two. Note closeness and accuracy of fit, elimination of leakage.

To Conduct 1 to 46 Circuits  
Like Continuous Wire . . . Yet  
Provides for a Quick Disconnect



Machine-time-out is time lost . . . money lost. The answer to that one, as learned by the aviation industry early in the days of fighter plane construction, is going to help all industry.

Today complex electrical circuits and operating units, in the plants as well as the planes, can be disconnected and reconnected in a few seconds time.

Interchangeable units can be replaced quickly. In the future, builders of electrical and electronic equipment of many types will use this improvement in design to their customers' advantage.

A typical Amphenol connector shown above, is being used all over the world by the Army, Navy and Air Corps under all kinds of conditions. Connections are absolutely secure! Shock or vibration cannot break them but they may be disconnected in an instant. Amphenol connectors are being made in water-proof, gas-proof, pressure-proof and other types—to mate with British equipment, still others for U.H.F. use.

If you're design-conscious be sure to get Amphenol-conscious. Write for descriptive catalog sheets.

AMERICAN PHENOLIC CORPORATION  
Chicago 50, Illinois

In Canada • AMPHENOL LIMITED • Toronto



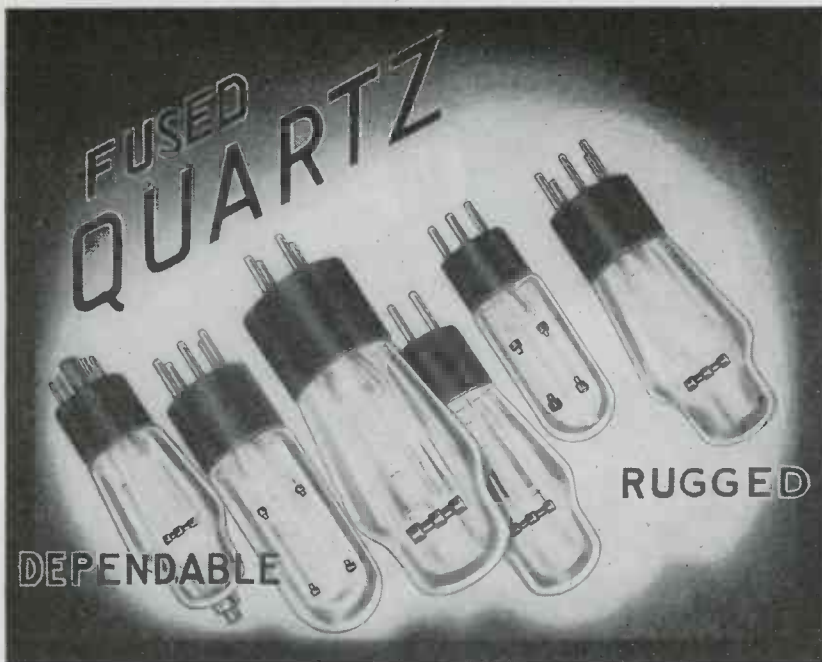

## INSULATORS

are a "main factor" of the high power electronic tube. Quartz is the best electrical insulator known to science. Many other qualities make it ideal for the job. . . . Not subject to thermal shock. Non hygroscopic. High surface resistance. Shaped to specification.

**ULTRA VIOLET LAMPS** (quartz mercury arcs)

**HYDROGEN ARCS IN QUARTZ**

**FUSED QUARTZ ROD,**

**TUBING, PLATES and SPECIAL SHAPES**

**HANOVIA**

**CHEMICAL & MANUFACTURING CO.**

Dept. EI-14

NEWARK 5, N. J.

### **Maguire Buys Thordarson**

In its second major expansion this year, Maguire Industries, Inc., has purchased from the Burgess Battery Company for cash all common stock of the 50-year-old Thordarson Electric Mfg. Co. of Chicago and Antioch, Ill. Founded by the late Chester H. Thordarson, an Iceland-born electrical pioneer, Thordarson is one of the oldest and best



Russell Maguire

known makers of transformers and amplifiers. The acquisition adds substantially to the transformer manufacturing facilities already owned by Maguire Industries at New Milford, Conn.

Mr. Maguire has been elected a director and president of Thordarson to succeed Jackson Burgess, who has resigned. Bartlett Pinkham and Eugene D. Powers, directors of Maguire Industries, have also been added to the board. The Thordarson company will continue to operate as a separate entity.

Anticipating that there would be an acute shortage of transformers, Maguire Industries established its own transformer division in 1943. It is the company's intention to increase Thordarson production immediately.

Although long famous for its amateur and broadcast transformer equipment, Thordarson recently has produced only industrial and specialty transformers and public address amplifying apparatus. Plans of the new management include a resumption of the manufacture of transformers for radio equipment. Maguire Industries in January added the Columbia Machine Works, Inc., of Brooklyn, N. Y., a producer of foundry products, electronic equipment and centrifuges, as a subsidiary.

### **Beebe's Premier Starts Transformer Production**

Premier Electronic Products, Inc., organized recently by J. R. Beebe, long time vice-president of Thordarson, is starting production of transformers. Both oil filled and hermetically sealed units will be included in the line. Headquarters are at 4849 North Western Avenue, Chicago.

### **Doyle to Gramer**

The firm name of James W. Doyle, Inc., 2734 North Pulaski Road, Chicago, has been changed to the Gramer Co. The company manufactures transformers and coils.

# transformer designs

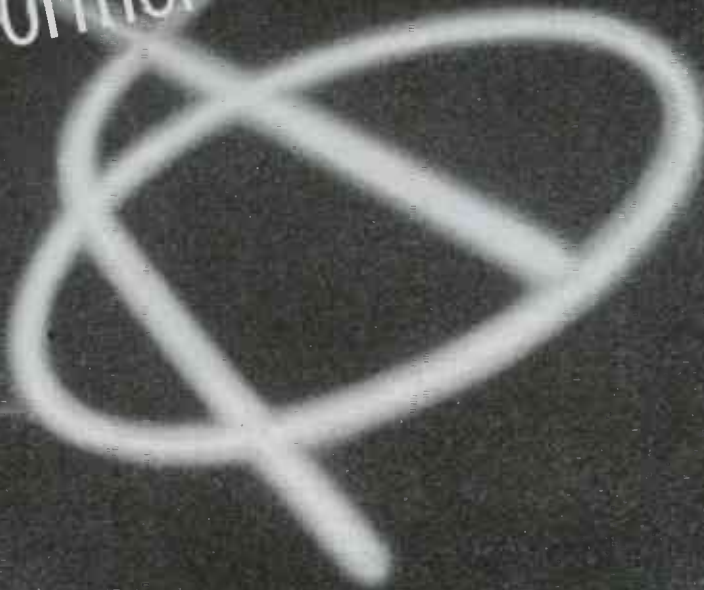

## FOR *Every* ELECTRONIC NEED

Although specialists in the design and quantity production of transformers for a quarter century, the demands of the past few years have brought about many developments. The requirements for military and essential industry purposes have multiplied many-fold with further emphasis on exactness and uniformity.

Transformer specialists before the War—great strides have been made in anticipating and meeting requirements of greatly varied character that have multiplied many-fold for military and essential industrial purposes.

Reports from all over the world emphasize the reliability of Jefferson Electric Transformers. Wherever used—on land, sea or in the air—in the frozen North, or hot, dry or humid tropics, the value of "quality" is being demonstrated daily.

Now is a good time to study your transformer requirements and let Jefferson engineers make recommendations that will save your time later.

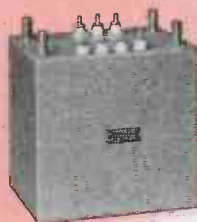

JEFFERSON ELECTRIC COMPANY

JEFFERSON  
ELECTRIC

BELLWOOD (SUBURB OF CHICAGO) ILLINOIS

IN CANADA: CANADIAN JEFFERSON ELECTRIC CO. LTD., 384 PAPE AVENUE, TORONTO, ONT.

# for POSITIVE HERMETIC SEALING



PART No.	Average of Actual Test Flash Over or Breakdown Voltage R.M.S.	Recommended Maximum Use Voltage at Sea Level R.M.S.
9820	4,750	2,500
9821	6,900	5,000
9822	9,624	7,500
9823	9,300	7,500
9824	12,725	9,000

INSULATION RESISTANCE OVER 1,000,000 MEGOHMS

## METAL-GLASS SEALS by STUPAKOFF

The series of Stupakoff metal-glass seals illustrated offers maximum electrical qualities consistent with space limitations and simplicity of design permitting mass production. They are suitable for operation at temperatures from  $-55^{\circ}\text{C}$  to  $+200^{\circ}\text{C}$ , and are tested to meet thermal shock specifications of the services. The construction provides a hermetic seal with a long electrical leakage path, resistance to thermal shock and mechanical strength.

Such seals are made possible by the metal, Kovar, a cobalt, nickel, iron alloy which matches the expansion of certain hard glasses from  $-80^{\circ}\text{C}$  to the annealing point of the glass (approx.  $+450^{\circ}\text{C}$ ). Kovar forms a seal through a heating process in which the oxide of Kovar is dissolved into the glass to form a perfect bond—pressure and vacuum tight under extreme climatic conditions.

Stupakoff furnishes Kovar-glass seals with single or multiple electrodes in various styles. For those equipped for glass working, Stupakoff supplies Kovar as rod, sheet, wire, tubing or fabricated into cups, eyelets or special shapes.

Write Stupakoff today for assistance in developing hermetically sealed components for war applications. Samples and reprints of this advertisement may be obtained by writing department K-56.

Actual Size Photograph

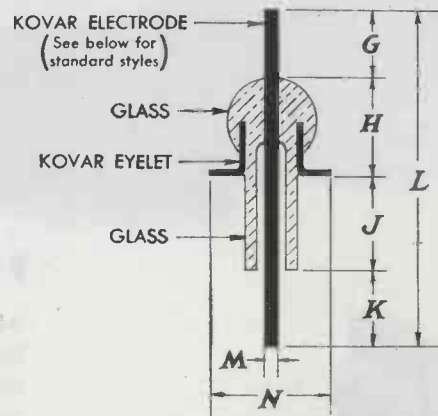

STANDARD SIZES (other sizes to your specifications)

PART	G	H	J	K	L	M	N
9820	$\frac{3}{16}$	$\frac{3}{16}$	$\frac{3}{16}$	$\frac{3}{16}$	$\frac{7}{8}$	.040	.212
9821	$\frac{1}{4}$	$\frac{3}{8}$	$\frac{1}{4}$	$\frac{1}{4}$	$1\frac{1}{8}$	.060	.340
9822	$\frac{1}{4}$	$\frac{11}{32}$	$\frac{13}{32}$	$\frac{1}{4}$	$1\frac{1}{4}$	.080	.380
9823	$\frac{1}{4}$	$\frac{11}{32}$	$\frac{13}{32}$	$\frac{1}{4}$	$1\frac{1}{4}$	.080	.500
9824	$\frac{1}{4}$	$\frac{1}{2}$	$\frac{1}{2}$	$\frac{1}{4}$	$1\frac{1}{2}$	.080	.672

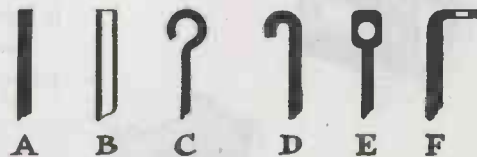

STANDARD ELECTRODE STYLES  
AVAILABLE IN COMBINATION  
(EXCEPT B)

Do More Than Before—Buy EXTRA War Bonds



STUPAKOFF CERAMIC AND MANUFACTURING CO., LATROBE, PA.

*Products for the World of Electronics*







ANOTHER  
**Jensen**  
 SPEAKER WITH  
**ALNICO 5**

• The reproducer unit in this loud speaker was especially developed by JENSEN for use in the intercom systems in navy vessels. It reproduces speech clearly and sharply through high levels of noise. Ruggedly built, it withstands extreme shock and vibration, and is weatherproof against severe weather exposure conditions, dust and smoke . . . Like all JENSEN military models, this speaker is built around the most powerful permanent magnet mate-

rial ever developed, *ALNICO 5*, as all JENSEN PM Speakers will be when conditions permit.

Now being introduced for the intercom systems on trains, and specifically designed for that purpose, this particular model has many possibilities for use wherever a heavy, rugged speaker with clear, sharp speech reproduction is needed. Write for complete engineering data on this speaker. Samples can be furnished on proper priority.



**Jensen**  
 SPEAKERS WITH **ALNICO 5**

*Specialists in Design and Manufacture of Acoustic Equipment*

JENSEN RADIO MANUFACTURING COMPANY, 3301 SOUTH LARAMIE AVENUE, CHICAGO 36, ILLINOIS

# PINCOR

## DC MOTORS

### BX SERIES

The urgent demand, in peacetime days, by the aircraft and radio industries for a compact, efficient D.C. motor was the challenge that led Pioneer to develop the Pincor BX series. Today Pincor BX motors flow from our plant in a steady stream to the producers of aircraft and radio equipment for the armed services.

Pincor BX motors, in their classification, meet the varied requirements of aircraft and radio manufacturers that demand light weight, compact motors for efficient and dependable application. Pincor BX motors are direct drive, ball bearing, high speed units wound for continuous or intermittent duty. Shunt, series or split series windings are for operation on 12 to 24 volt battery systems currently used and may be easily modified to meet your product demand.

Depend on these rugged Pincor quality-proven motors in the BX series. Send your problem to Pioneer engineers and let them put their years of experience to work for you. Consultation with these men will not obligate you in the least.

DYNAMOTORS • CONVERTERS  
GENERATORS  
POWER PLANTS • GEN-E-MOTORS

**PINCOR**  
*Products*

**PIONEER GEN-E-MOTOR**  
CORPORATION

5841-49 DICKENS AVENUE CHICAGO 39, ILLINOIS

Export Office, 25 Warren Street, New York 7, U.S.A.

Cable Address: Simonrice, N.Y.

**BUY MORE BONDS!**

## Lear Demonstrates Home Wire Recorder

Adaption of wire recording of speech and music to home use was demonstrated by Lear, Inc., in New York, April 10. The recorder, incorporated in a console radio set featured a detachable magazine containing the recording wire mounted on spools. Such maga-



W. P. Lear shows interchangeable wire magazine for recording as used with home radio set

zines, which can be sold for about \$10 each, hold enough wire for one hour's recording. William P. Lear, president of the company, stated the entire recording mechanism would add \$75 to \$100 to the cost of home radios and occupy a space 8 in. on each side. The recording can be played back any number of times or erased for new recordings.

## WE Moves Traffic

Headquarters organization of the Western Electric Co.'s traffic department, located at the Hawthorne Works in Chicago since 1918, was moved to the company's general headquarters at 195 Broadway, New York 7, N. Y., middle of April. The transfer was made to coordinate the expanded activities of the traffic organization with those of the company's other general departments at headquarters.

## Rohr-Detrola Join

International Detrola Corp., which operates a radio-electronics plant in Detroit, and Rohr Aircraft Corp., whose operations center in Chula Vista, California, have agreed upon an exchange of stock interests thus providing each with opposite coast facilities for expansion of a post-war plan for radio and aviation products. International Detrola plans a West Coast assembly plant for radio to serve that area. In addition to its Detroit plant the company also has manufacturing facilities in Elkhart and Indianapolis, Ind.

# Another Famous D-H Alloy Advance



... does **3** JOBS EFFICIENTLY

Advance\* is a Driver-Harris alloy made from electrolytic Nickel and Copper under close control of exclusive Driver-Harris methods. It possesses a number of remarkable properties ideally suited for these 3 distinctly different applications.

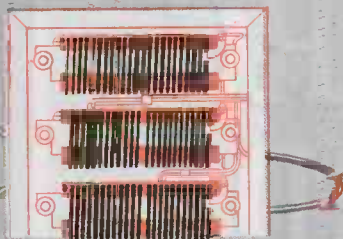

High electrical resistance (294 ohms per Circular Mil-foot), great ductility and non-corroding properties make it particularly good for winding heavy duty industrial resistors employed in motor starting and controlling equipment. Both wire and ribbon are used in this application.

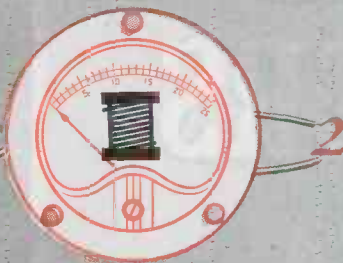

In finer sizes negligible temperature co-efficient of resistance ( $\pm .00002$ ) combined with high resistivity makes it the most desired resistance alloy for winding precision resistors of the type used in electric meters and laboratory testing devices.

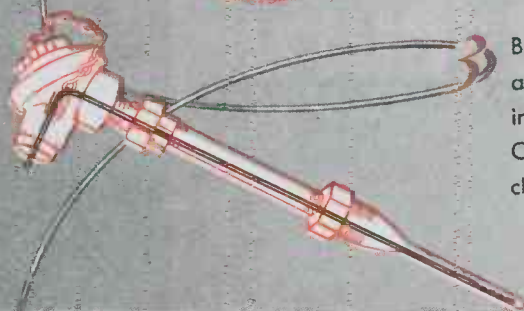

Because Advance\* develops high and uniform thermal e m f against Platinum, Copper or Iron, it is used extensively by all instrument manufacturers in the well-known Iron-Advance and Copper-Advance (Constantan) Thermocouples. Small temperature changes are clearly indicated through larger scale deflections.

\*Trade Mark Reg. U. S. Pat. Off.

Advance\* is only one of a large, famous family of versatile Driver-Harris resistance alloys that can be relied upon to make your post-war products more dependable. For important information about improved resistance alloys write for a free copy of Data Book R-42 . . . a complete text on Advance and other D-H alloys.



## Driver-Harris COMPANY

HARRISON, NEW JERSEY

BRANCHES: CHICAGO • DETROIT • CLEVELAND  
LOS ANGELES • SAN FRANCISCO • SEATTLE

Special Purpose Alloys Since 1899

**FEWER  
MOVING  
PARTS**

assures a more

**DEPENDABLE**

line of post victory

**SEEBURG  
RECORD  
CHANGERS**

BUY WAR BONDS

Awarded to the J. P. Seeburg Corporation for outstanding production of war materials in each of its four plants



**J. P. SEEBURG CORPORATION · CHICAGO**

**Seeburg**

FINE MUSICAL INSTRUMENTS SINCE 1909

Awarded to the J. P. Seeburg Corporation for outstanding production of war materials in each of its four plants

Announcing



# THE 25-AMP SWITCHETTE

"Big" brother of our little 10-amp Switchette

THIS new form of G-E Switchette is suitable for a wide variety of limit-switch and other industrial control applications where space is limited and long life is required.

This new (Size 2) Switchette is rated 25 amperes at 24 volts d-c (115 volts a-c). It has screw-type terminals for easy wiring, and is completely enclosed for protection from dust.

Three contact arrangements are available: single-circuit, normally closed; single-circuit, normally open;

and two-circuit. These Switchettes are suitable for use at altitudes up to 50,000 feet, and in temperatures from 93.5 C to minus 56.6 C. They resist corrosion and high physical shock and vibration, and are designed to withstand millions of mechanical operations.

Approximate dimensions are 2 by 1 3/8 by 1 inch; approximate weight is 2 ounces. Ask your local office for Bulletin GEA-4259, which gives dimensions and complete description. *General Electric Company, Schenectady 5, N. Y.*

Size 1 Switchette Actual Size



### AND DON'T FORGET

We also have more than 200 forms of the original (Size 1) Switchette, as well as a variety of compact limit switches, transfer and selector switches, and other control devices built around this tiny contact mechanism. The Size 1 Switchette is rated 10 amperes at 24 volts d-c, and its dimensions are 1 1/4 by 1/2 by 1/2 inch. Bulletin GEA-3818 gives complete specifications and dimensions.

General Electric Company, Section 676-143  
Schenectady 5, N. Y.

I would like to have more information on Switchettes. Please send me

- .....Bulletin GEA-3818, covering Size 1
- .....Bulletin GEA-4259, covering Size 2

Name.....  
Company.....  
Address.....

# GENERAL ELECTRIC

SENSITIVITY



CONTACT PRESSURE



DEPENDABILITY



DURABILITY



COMPACTNESS



VERSATILITY

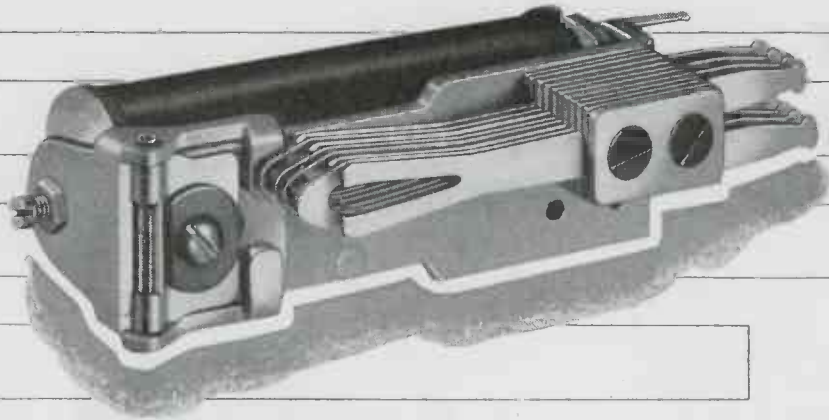
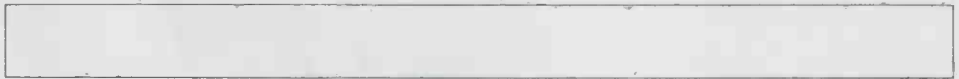

# — *in Greatest Combination*

## THE NEW AUTOMATIC ELECTRIC CLASS "B" RELAY

• When you need a relay that's sensitive enough to operate on minute current, yet has the high contact pressure needed for perfect closure, you'll find the Automatic Electric Class "B" Relay worth investigating.

If you need a relay that will switch many circuits, yet is compact enough for multiple mounting in small space, you'll find Class "B" the perfect solution.

Or perhaps you are interested in extra durability, for long service under tough conditions. Then you'll need the in-built quality for which Class "B" has become famous.

No other relay—even in the Automatic Electric line—can give you a greater combination of all these essential qualities. Get the full story on Class "B"—one of the forty basic types described in the Automatic Electric catalog. Ask for your copy of Catalog 4071.

### CHECK THESE FEATURES of the New Class "B" Relay

*Independent Twin Contacts*—for dependable contact closure.

*Efficient Magnetic Circuit*—for sensitivity and high contact pressure.

*Unique Armature Bearing*—for long wear under severe service conditions.

*Compact Design*—for important savings in space and weight.

*Versatility*—Available for coil voltages to 300 volts d-c and 230 volts a-c, and with capacities up to 28 springs; also with magnetic shielding cover, when specified.

**No other relay can give you a greater combination of all these essential qualities.**

*Relays*  
AND OTHER CONTROL DEVICES  
*by* **AUTOMATIC ELECTRIC**



**AUTOMATIC ELECTRIC SALES CORPORATION**

1033 West Van Buren Street • Chicago 7, Illinois

In Canada: Automatic Electric (Canada) Limited, Toronto

PARTS AND ASSEMBLIES FOR EVERY ELECTRICAL CONTROL NEED

# THE WESTINGHOUSE

# IGNITRON

...the electronic tube that revolutionized the use of D-C power is the key to many more electronic applications.

In 1932 Westinghouse created the sealed ignitron, making possible compact portable equipment to supply the heavy and precisely timed d-c currents required in resistance welding. High-speed welding of aluminum and stainless steel became possible, and volume production of uniformly welded products became economically practical.

Today there are two basic types of Westinghouse sealed ignitrons: One for resistance welding; the other for power conversion.

There are four Westinghouse welding ignitrons, rated up to 2400-kva capacity. While they are now used mainly for joining light metals, they are capable of handling heavy metals. The wartime experience gained in resistance welding similar and dissimilar metals is opening new opportunities in the field of fabrication.

There are two Westinghouse ignitrons for power rectifier applications: a 100-ampere and a 150-ampere tube at d-c output voltages up to 600-volts. Ignitron rectifiers often can be used profitably to replace conventional rectifying equipment. The high capacity of the ignitron opens a new field in motor speed control where motors of greater than usual horsepower must be controlled within very close limits.

Westinghouse ignitrons are now available in your Westinghouse distributors stock for immediate delivery.

Westinghouse engineers will be glad to advise you on problems of application of the ignitron. Write Westinghouse Electric & Manufacturing Company, Lamp Division, Bloomfield, N. J.

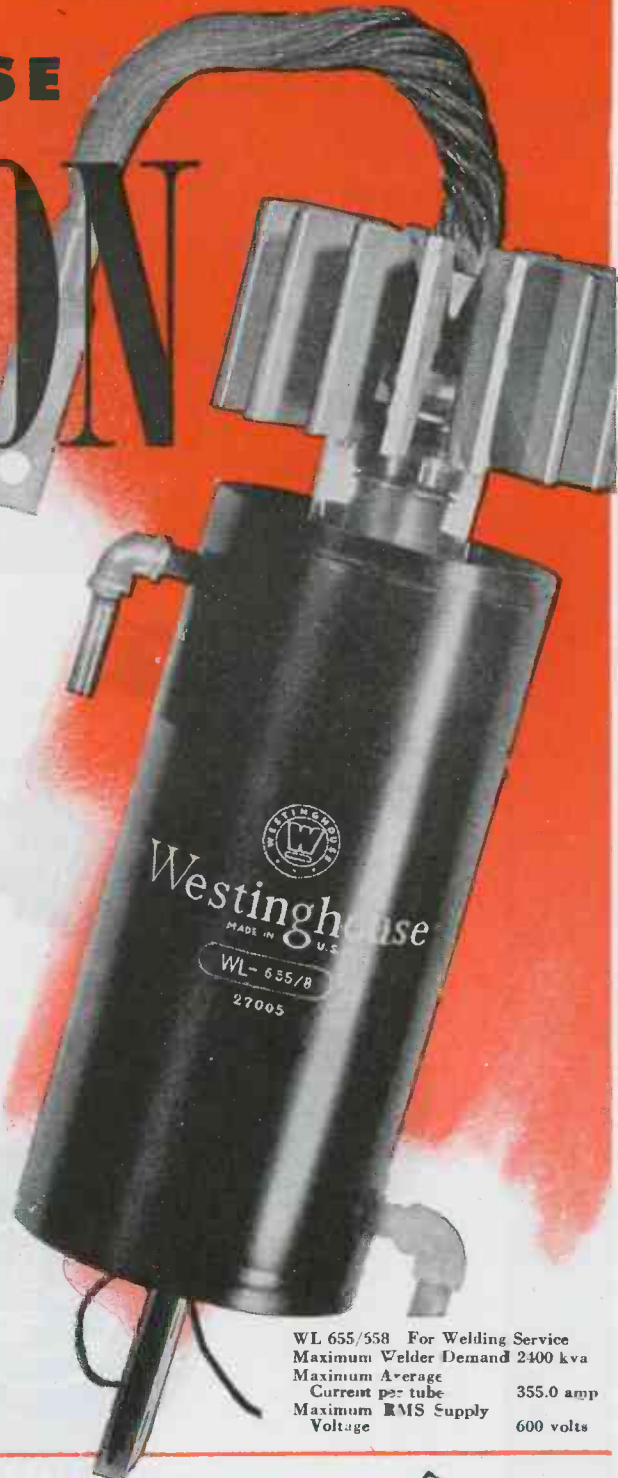

WL 655/558 For Welding Service  
 Maximum Welder Demand 2400 kva  
 Maximum Average Current per tube 355.0 amp  
 Maximum RMS Supply Voltage 600 volts

## Westinghouse

PLANTS IN 25 CITIES OFFICES EVERYWHERE

*Quality Controlled Electronic Tubes*



WL 651/656 For Welding Service  
 Maximum Welder Demand 1200 kva  
 Maximum Average Current per tube 140.0 amp  
 Maximum RMS Supply Voltage 600 volts



WL 681/686 For Welding Service  
 Maximum Welder Demand 300 kva  
 Maximum Average Current per tube 22.4 amp  
 Maximum RMS Supply Voltage 600 volts



WL 679 For Rectifier Service  
 D-C Output Average Current per tube  
 Voltage Continuous 2 hours 1 minute  
 300 100 amp 150 amp 200 amp  
 600 75 amp 112.5 amp 150 amp



WL 653-B For Rectifier Service  
 D-C Output Average Current per tube  
 Voltage Continuous 2 hours 1 minute  
 300 200 amp 300 amp 400 amp  
 600 150 amp 225 amp 300 amp

# RESISTANCE PLUS

From the tropics to the arctics—on land, sea and in the air, **HARDWICK, HINDLE** resistors and rheostats are serving with distinction.



**HARDWICK, HINDLE, INC.**

**RHEOSTATS and RESISTORS**

DIVISION OF

**THE NATIONAL LOCK WASHER COMPANY**

ESTABLISHED 1886

**Newark 5, N. J., U. S. A.**

## PERSONNEL



Harold Detrick



Charles P. Geyh

**Harold Detrick** has been appointed chief engineer for the company's forthcoming line of AM and FM radios and radio-phonograph combinations by Bendix Radio division of Bendix Aviation Corp. **Charles P. Geyh**, formerly associated with General Electric and RCA in cabinet design activities has been made cabinet design and production engineer for the company. Detrick formerly was chief engineer of the General Instrument Corp., Elizabeth, N. J., and previously assistant chief engineer for Stewart-Warner. He began his radio career in 1928 as a design engineer for the United States Radio and Television Co. Geyh is one of the nation's authorities on radio cabinet design and manufacture.

**C. P. Pesek** has been appointed administrator of engineering of Minnesota Mining & Mfg. Co., St. Paul. **W. A. Thomas**, assistant chief engineer, is made engineering consultant on Mr. Pesek's staff.

**Colonel J. Z. Millar**, U.S. Army Signal Corps, has been appointed radio research engineer by the Western Union Telegraph Co. He has been on inactive service since January, was formerly executive officer of the Signal Corps Board at Fort Monmouth, N. J. He first joined Western Union in 1923, left that company's electronics department in 1941 to join the Army.

**Ralph R. Beal**, assistant to the vice president in charge of RCA laboratories and for nine years research director of the Radio Corp. of America, has been elected vice-president of RCA Communications, Inc., in charge of engineering. Serving as research director from 1934 to 1943, Mr. Beal originated and supervised programs of research which constantly broadened the field of radio's products and services. Among major developments during this period were the application of radio-electronics to numerous non-communication purposes, the electron microscope, television, theater television, radar, radio relays, and the opening of the microwave section of the radio spectrum. (Continued on page 188)





# MORNING BECOMES ELECTRIC!

Photographers use a small box they call an exposure meter. They take it for granted, like flicking a switch to light a room. But while vast generating systems bring power to your house, a light source alone works a meter or meter relay—when a photocell converts that light into electric energy. The simplicity and ruggedness of an exposure meter typify all Luxtron\*

photocell applications—from taking a good picture to precisely matching colors—from putting out a fire to increasing the heat of a furnace. No amplifiers are needed. Long equipment life is assured, under the most strenuous operating conditions. Ask Bradley how photocells can meet your own measurement or control problems.

## Versatile "Coprox" Rectifiers



This is one of the unique Bradley line of copper oxide rectifiers, made with the same understanding of electrical circuits and pyrometallic phenomena that goes into Luxtron photocells. Write for illustrated "Coprox" bulletin.

\*TRADE MARK REG. U. S. PAT. OFF.

PHOTOCELLS—MASTERS OF LIGHT

# BRADLEY

MASTER OF PHOTOCELLS

BRADLEY LABORATORIES, INC., 82 MEADOW STREET, NEW HAVEN 10, CONNECTICUT

ELECTRONIC INDUSTRIES • May, 1945

# SYLVANIA NEWS

ELECTRONIC EQUIPMENT EDITION

MAY Published by SYLVANIA ELECTRIC PRODUCTS INC., Emporium, Pa. 1945

## SYLVANIA'S CHART AIDS STANDARDIZATION OF TUBES

### Reference List Recommendations Reduce Radio Tube Types

AS an aid to the standardization of radio receiver tube types, Sylvania has prepared the chart reproduced below—another item in Sylvania's long-time program of technical assistance to the radio industry.

The number and variety of tube types have grown in recent years, and this trend has intensified war scarcities.

Naturally, it would seem to be advantageous to radio set manufacturers to further standardize tube selection and limit their variety. This would probably meet with approval in many parts of the

radio industry, particularly among radio servicemen since they are in an active position when it comes to tube replacement and general radio set repairing.

(An indication of their opinion concerning tube types was revealed in Sylvania's survey in which 90.5% of the servicemen questioned said they would prefer fewer and simpler tube types.)

This handy reference chart will help smooth some of the wrinkles of the problem and act as a future guide. Write for it to Sylvania Electric Products Inc., 500 Fifth Ave., New York 18, N. Y.

## Double Triode Tube Has Two Uses

### Acts As Converter Or Amplifier

Sylvania's new high mutual conductance double triode tube—Type 7F8—is designed for use at frequencies up to 300 or 400 Mc.

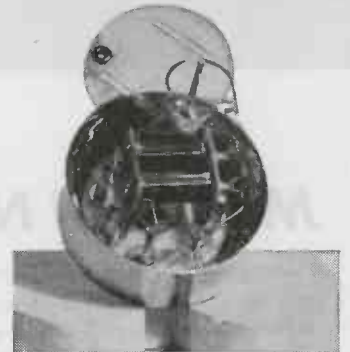

With precautions the two sections may be used separately, saving space and the number of tubes required for a given performance since all the elements except the heaters are independent.

The cascade operation thus made possible is useful in u-h-f grounded grid and cathode follower amplifier service. It may also be used as a push-pull u-h-f amplifier.

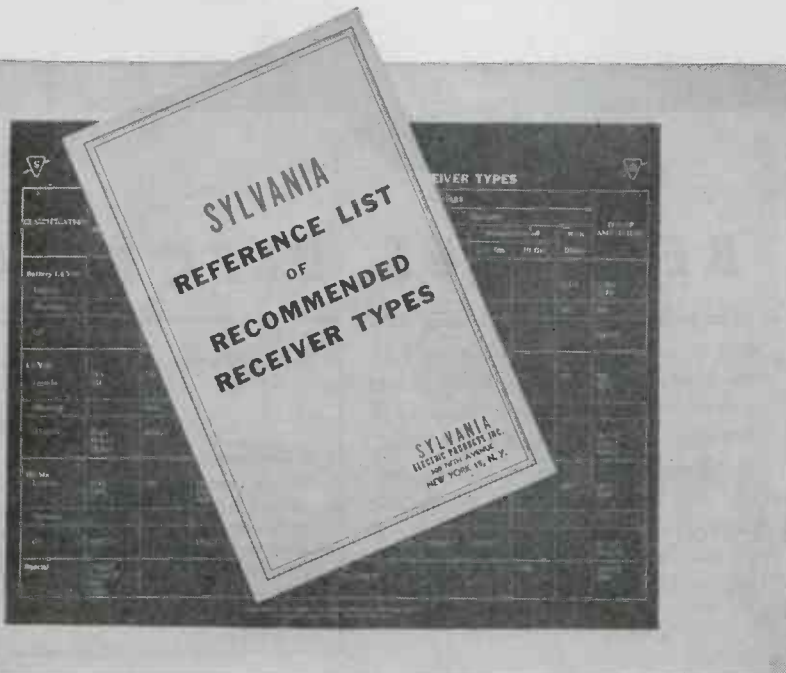

# SYLVANIA ELECTRIC

MAKERS OF RADIO TUBES; CATHODE RAY TUBES; ELECTRONIC DEVICES; FLUORESCENT LAMPS, FIXTURES, ACCESSORIES; INCANDESCENT LAMPS

# SUCCUSSION

## RESEARCH..

### .. ON ELECTRICAL CONNECTORS



**S**uccussion\* in some form . . . from mild vibration to heavy shock . . . is present around every electrical connector in service. If succussion wins, circuit efficiency drops or service stops . . . and costly maintenance begins.

How, then, can you be sure the connections you make, in your product or in your plant, will remain unaffected by mechanical abuse? You'll find the answer here in Burndy's torture chamber where connectors are 'pre-tested' through a rigorous physical 'workout'.

Hour after hour, they are vibrated at varying frequencies and amplitude. But in addition, very unusual methods are employed to add shock, stress and twist as well. After which their electrical resistance and strength are carefully measured to make sure there has been no change . . . that they are worthy of the Burndy name.

These 'physicals' are but part of the thorough test procedure here in the Burndy laboratories . . . all aimed to assure that your circuits or equipment suffer no connection troubles in service. If you don't have the Burndy catalog, let us send you a copy. Burndy Engineering Co., Inc., 107K Bruckner Boulevard, New York 54, N. Y.

\*Succussion: forcible shaking, violent shock.



Headquarters for  
CONNECTORS

# Burndy

In Canada: Canadian Line Materials, Limited, Toronto 13

# T IS FOR "TROPICALIZED"

... which means that **STANDARD** Sprague Koolohms now have the same **EXTRA HUMIDITY PROTECTION** formerly obtainable only on special order.



All Sprague Koolohm Resistors are now supplied with glazed ceramic shells and a new type of end seal as standard construction.

These features provide maximum protection against the most severe tropical humidity and corrosive conditions. Extensive tests in the laboratories of the armed forces and prime contractors have proven the ability of the "KT" construction to "take it" under the most brutal air thermal shock, humidity, and corrosive conditions.

Type "KT" Koolohms correspond to characteristic "J" of resistor specification JAN-R-26.

All previous catalog designations remain the same except for the addition of the letter "T" to the old type numbers to designate the new standard construction.

Thus "T" is for "Tropicalized"—and all Sprague Koolohms have it. One type of Koolohm, the *standard* type, does the job—under any climatic condition, anywhere in the world.

SPRAGUE ELECTRIC CO., Resistor Division, North Adams, Mass.  
(Formerly Sprague Specialties Co.)

WOUND WITH  
CERAMIC  
INSULATED  
WIRE

DOUBLY  
PROTECTED  
by glazed  
CERAMIC SHELLS and  
NEW TYPE END SEALS



# SPRAGUE

# KOOLOHM RESISTORS

TRADEMARK REG. U. S. PAT. OFF.

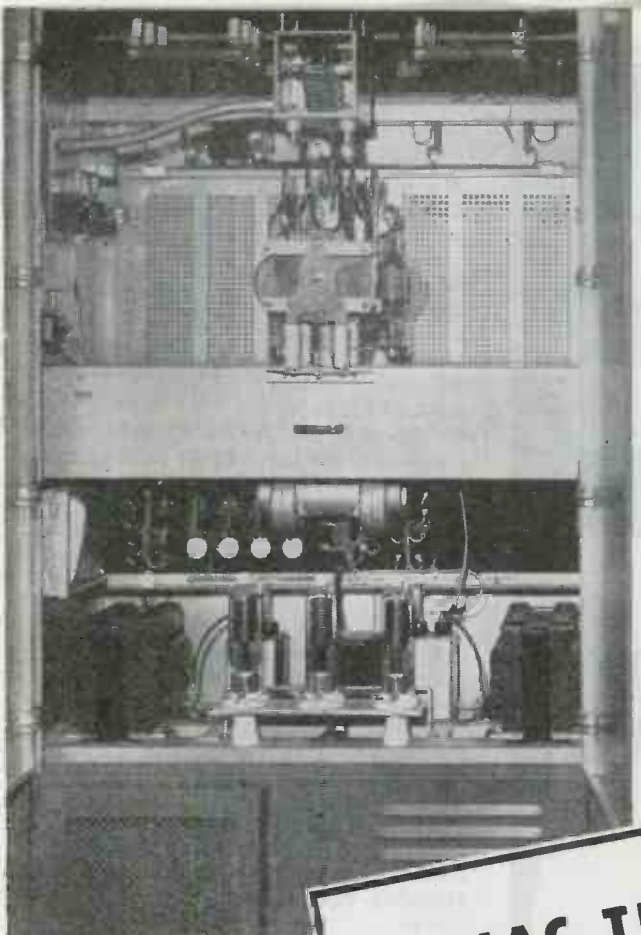

pair of Eimac 1000-T's give 3 KW output in this Link-built FM transmitter for the emergency services.

Here's a 500 watt supersonic test generator for operation at 1 to 300 Mc which uses Eimac 152-T tubes.

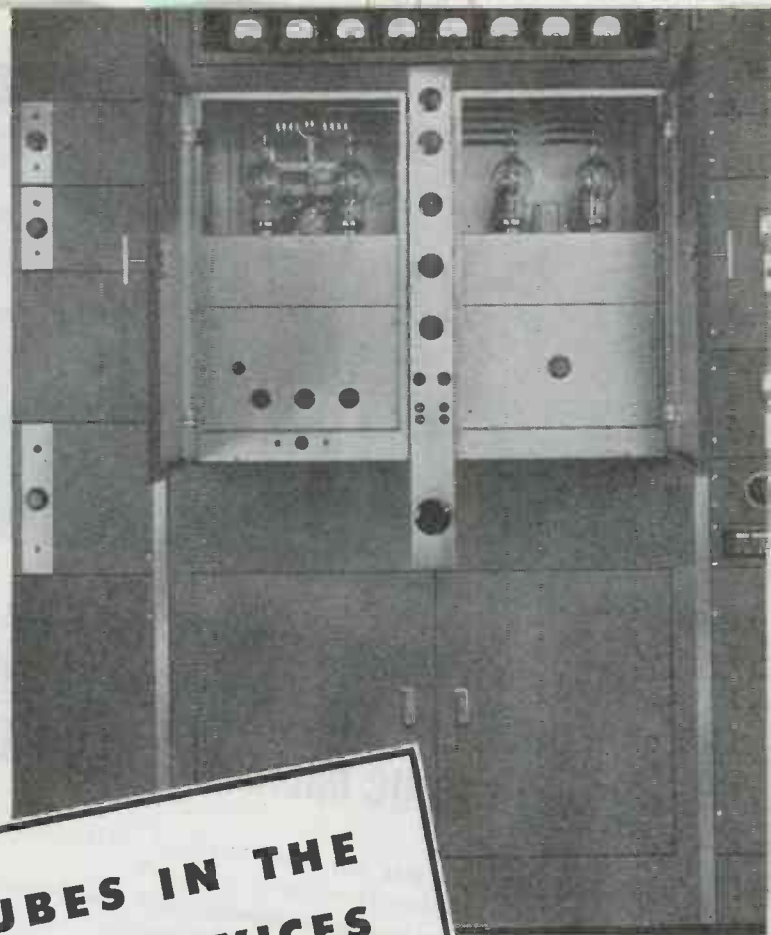

500 watt AM police transmitter for 30-40 Mc operation, built by Fred M. Link, using Eimac 250-TH tubes in the final.

**EIMAC TUBES IN THE  
EMERGENCY SERVICES  
WHERE DEPENDABLE  
PERFORMANCE COUNTS!**

The transmitters shown on this page were developed and built for the emergency services — police, fire and transportation — by Link Radio Corporation of New York City. Recognition such as that enjoyed by the Link organization in this field is built upon sound engineering and the right choice of equipment components. That Eimac tubes occupy the important sockets in these vital transmitters is fitting acknowledgement of their inherently superior performance capabilities. That Fred M. Link specifies Eimac tubes is confirmation of the fact that Eimac tubes are first choice of leading electronic engineers throughout the world.

**FOLLOW THE LEADERS TO**

Get your copy of *Electronic Telesis* ... the sixty-four page booklet which gives the fundamentals of electronics. This little booklet will help electronic engineers explain the subject to laymen. It's yours for the asking ... no cost or obligation. Available in English and Spanish languages.



EITEL-McCULLOUGH, INC., 1033 San Mateo Ave., San Bruno, Calif.  
Plants located at: San Bruno, California and Salt Lake City, Utah  
Export Agents: Frazer & Hansen  
301 Clay Street, San Francisco 11, California, U.S.A.

## Personnel

(Continued from page 182)

**Charles R. Denny**, FCC General Counsel who so ably participated in the Washington hearings which followed proposed allocation of the radio spectrum between 10 kc and 30,000 kc, has been confirmed by the Senate as a Commissioner. He will take the place of T. A. M. Craven, who resigned in July 1944, and his tenure of office will run seven years from that date until June 30, 1951.



**E. W. D'Arcy** has been appointed chief engineer of DeVry Corp., Chicago. Formerly research engineer of Essanay Film Corp., D'Arcy joined DeVry in 1940 in a similar capacity. In this post he contributed materially to design and production developments in the manufacture of motion picture sound, radar navigating and gunnery training equipment for the armed forces.

**William J. Muldoon**, formerly connected with the Control Instrument Corp., and **Joseph R. Miller**, formerly of Bendix Marine Corp., have become associated with Guided Radio Corp., 161 6th Ave., New York, N. Y. They will both be connected with the engineering division of the company.



George L. Beers

D. F. Schmit

**D. F. Schmit** has been appointed director of engineering of the RCA Victor Division. He was formerly assistant chief engineer and will fill the post vacated by Dr. J. B. Jolliffe, who recently was elected vice president of the Radio Corp. of America in charge of RCA Laboratories. At the same time **George L. Beers** has been made assistant director of engineering in charge of advance development. He was formerly on the engineering administrative staff.

(Continued on page 268)

# Here's why SPERTI HERMETIC SEALS are A "MUST" IN THE TROPICALIZATION OF ELECTRONIC MILITARY EQUIPMENT

1. EFFECTIVELY SEAL OUT DUST, sand, salt spray, fumes, fungus, injurious atmosphere.
2. GLASS PATH WILL NOT CARBONIZE. Have wide thermal operating range and high insulation leakage resistance.
3. SPECIAL PROCESS insures maximum acceptability to solder. Simple and easy to attach.

Sperti Hermetic Seals have been an important factor in increasing the life expectancy and usefulness of vital military equipment of many kinds. Write, today. Outline your problems. Let us show you how Sperti Hermetic Seals can help you solve them.

## THE HELP YOU'VE BEEN LOOKING FOR!

Now available. Skilled assembly service for soldering terminals into cover plates. Send drawings and specifications for quick quotation. For full information, phone, wire or write.

# Sperti

INCORPORATED  
Cincinnati, Ohio



# INSIST ON PROOF BY TRIAL

before you buy an  
Electronic Heater

This is how Scientific Electric proved the value of electronic heating to the Progressive Welding Company of Norwalk, Connecticut . . .

**G**REAT improvements in product quality and remarkable savings in time and money are being achieved by means of electronic heating. Industrialists everywhere are now acclaiming its many advantages. But don't let your enthusiasm lead you to invest in an electronic heater before you have seen it perform the work you expect of it.

Another important point is this . . . in order to work at maximum efficiency and live up to its reputation for doing things better, faster and cheaper . . . electronic heating must be "tailored" to the job. That is why we never sell a Scientific Electric unit until it has been satisfactorily demonstrated. Regardless of the amount of time and effort required, our engineers will not release a single machine for sale until it has fulfilled every claim we make for it.

So here is a word of counsel . . . get plenty of advice before you buy. Consult with our recognized engineers who have pioneered in electronic heating since 1921 and, without obligation, they will demonstrate what electronic heating can do for you.

## Scientific Electric

Division of

"S" CORRUGATED QUENCHED GAP COMPANY

119 MONROE ST.  GARFIELD, N. J.

Manufacturers of

Vacuum Tube and Spark Gap Converters Since 1912

ELECTRONIC INDUSTRIES • May, 1945



Above: This practical automatic brazing turntable powered by a 40 KW. Scientific Electric heater speeded up production 700%—cut costs 87% and reduced rejects by 90%.

Left: Close-up of the finished two-piece tube assembly after being brazed by induction heating. Three complete brazing installations have been built for Progressive.



Write for a free copy of our handbook . . . *The ABC of Electronic Heating* which contains an easily understood explanation of this new heating method.

40 KW INDUCTION HEATER

Scientific Electric Electronic heaters are made in these power sizes . . . and a range of frequencies up to 300 Megacycles depending upon power requirements.

3 KW	18 KW
5 KW	25 KW
7½ KW	40 KW
8 KW	60 KW
10 KW	80 KW
12½ KW	100 KW
15 KW	250 KW

# PRINTED, ILLUSTRATED NEWS BY RADIO

... with paid advertising

THE POST-WAR facsimile "newspaper of the air" will take printed and illustrated news direct into homes by radio, at a speed equivalent

to more than 12\* tabloid-size pages per hour! Who will be first, in your territory, to use this most modern type of publishing?

*\*Even greater speeds are technically possible with Finch equipment, and can be obtained where the available radio channels are sufficiently broad.*

**finch facsimile**  
DELIVERS PICTURES AND TEXT BY RADIO OR WIRE

**WANTED**  
MORE NAVY NURSES  
BE A COMMISSIONED OFFICER  
IN THE U.S. NAVY

**WINSHIP**

**WORLD'S FASTEST COMMUNICATION SYSTEM**  
Finch Telecommunications, Inc., Passaic

## SELF SYNCHRONIZING **finch facsimile**

DELIVERS PICTURES AND TEXT BY RADIO OR WIRE

FINCH TELECOMMUNICATIONS, INC. • PASSAIC, N. J.

N. Y. Office: 10 E. 40th St., New York 16, N. Y.



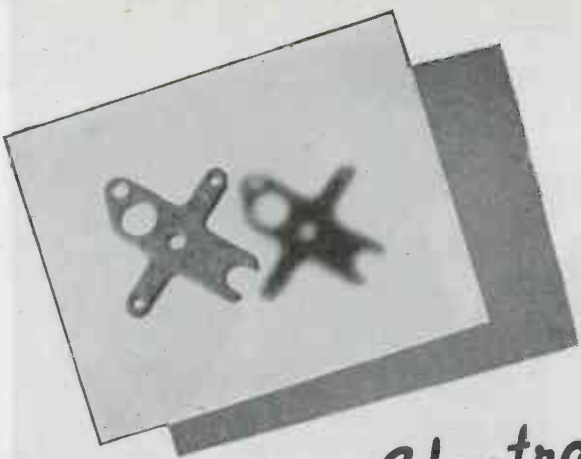

# Superior Electronic Components WITH INJECTION MOLDED G-E MYCALEX

G-E Mycalex is doing a big job for the electronic industry. A speedy yet precision type of injection molding developed by the General Electric Company allows intricate shapes to be molded to extremely close tolerances.

G-E Mycalex can be molded with metal inserts, and as a result, the metal and the G-E mycalex are fused into an unusually strong bond.

Having over-all electrical properties superior to porcelain products and refractory qualities superior to organic plastics, G-E mycalex remains the all-purpose, high-heat, high-frequency insulation material for use in the radio and electronic industries.

For further information write Section T-51, General Electric Company, One Plastics Avenue, Pittsfield, Mass.

- G-E mycalex has the following properties:
1. High dielectric strength.
  2. Low power factor.
  3. Prolonged resistance to electric arcs.
  4. Chemical stability; no deterioration with age.
  5. Dimensional stability; freedom from warpage, shrinkage, etc.
  6. Imperviousness to water, oil and gas.
  7. Resistance to sudden temperature change.
  8. Low co-efficient of thermal expansion.

Hear the General Electric radio programs: "The G-E All-Girl Orchestra" Sunday 10 P.M. EWT, NBC. "The World Today" news every weekday 6:45 P.M. EWT, CBS. "G-E House Party" every weekday 4:00 P.M. EWT, CBS.

Buy War Bonds

**GENERAL**  **ELECTRIC** PD-51

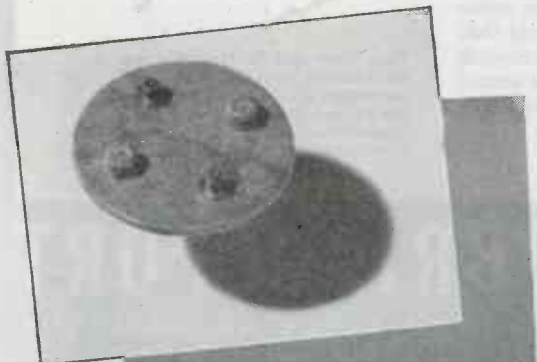
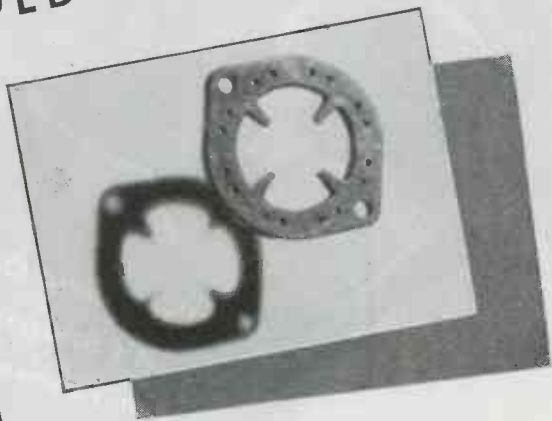

*"Be On the Lookout For Good  
Postwar Suppliers, Sam."*

*"I've Found One Already, Mr. Davis,  
It's Bridgeport For Coils . . . and  
Our Postwar Order Is Already In."*

## JOIN THE SWING TO BRIDGEPORT FOR COILS

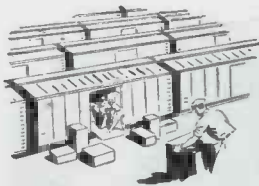

Dozens of manufacturers are placing orders with Bridgeport *now* to be sure of early postwar deliveries of R.F. Coils and Chokes, I.F. Transformers and Transmitting Coils and Chokes. They know that the same personnel and the same capacity that enables Bridgeport to supply Search Coils and Variometers for the armed forces will make them a logical supplier in the postwar period.



They know that Bridgeport's central location gives them the added advantage of fast, trunk line service to any point in the United States when delivery is an important factor. Write to us today.

# BRIDGEPORT

MANUFACTURING COMPANY  
Bridgeport, Illinois

R. F. Coils • R. F. Chokes • I. F. Transformers  
Transmitting Coils • Transmitting Chokes

# Reflection of Superior

WORKMANSHIP  
EXPERIENCE  
DESIGN



Announcing  
POWERSTATS  
TYPES 116 and 216

NOT only does the image in the mirror show a view of these 1 KVA POWERSTATS but it reflects the years of experience gleaned by SECO engineers in designing variable voltage transformers. All the "know-how" gained through laboratory research, technical achievement, and customer demand is incorporated into these new 116 and 216 models . . . assuring a POWERSTAT with features offered by no other unit of comparable size.

	TYPE 116	TYPE 216
Input . . . . .	115 volts, 50/60 cycles	230 volts, 50/60 cycles
Output voltage . . . . .	0-115 and 0-135 volts	0-230 and 0-270 volts
Output current . . . . .	7.5 amperes available over entire output voltage range.	3.0 amperes available over entire output voltage range.
Output watts . . . . .	1000 va	810 va
No-load power loss . . . . .	3.5 watts	3.5 watts
Dimensions . . . . .	Over-all — 5 1/16 x 6 7/8 x 6 3/8 inches high 3 mounting holes — 120 degrees apart on 2 1/2 inch radius.	

As illustrated, this type of POWERSTAT is available either cased or uncased . . . the uncased model designated by the letter "U" following the type number.

For further information, write for your copy of bulletin 116 IE.

## SUPERIOR ELECTRIC COMPANY

461 LAUREL STREET • BRISTOL, CONNECTICUT

## 100-300 MC EQUIPMENT

(Continued from page 97)

put and resonated by means of the "butterfly" tank in the plate circuit of the 6J6 multiplier V4; the other signal is applied to a "butterfly" tank in the grid circuit of the mixer (V5). The output of V5 is applied to V6, A 9002 which functions as a rectifier, furnishing the audio frequency voltage which results from the "beating" of the two signals under investigation. The usable range of this function is 100-350 mc, which is the frequency coverage of the "butterfly" tank component.

With V4, connected as shown in the schematic (push-push) the output frequency range is, in conjunction with the frequency standard, of course, 100-200 mc. If it is connected push-pull, (tripler) the range is then 150-300 mc.

The signal to be measured is picked up by a Faraday shielded probe shown in Fig. 5. This probe is connected to the unit by flexible coaxial cable, and can be used any reasonable distance from the unit. Other methods may be used to introduce the signal, whose frequency is to be measured; however, the shielded probe has obvious advantages, and is recommended for transmitter work.

With this unit, frequencies within this vhf range can be measured directly. The unit can be used in production tests of transmitters without necessitating the other units being shut down during frequency measurements because of interference. It can be located in a convenient place in the laboratory or test room, its signal being fed to it via coaxial cable. It can be used directly to measure the frequency swing of FM transmitters. It can, of course, be used as a standard vhf signal generator of high accuracy.

### Silicone Coatings

Development of a new water-repellent and thermal-shock-resistant coating for wire-wound resistors for radio equipment was announced at a recent meeting of resistor and ceramic tube manufacturers. The insulating material was developed from a new group of resins known as silicones. The resistors have been tested in conformity with rigid Navy specifications and have been found to meet the requirements for resistors having the highest resistance to moisture penetration and operating at maximum temperatures of 275 degrees Centigrade. This coating material, because of its high elasticity, can be applied to any combination of ceramic or metal cylinders with resistance wire of suitable electrical characteristics.



# Quality ...

## A Success Secret of CAPACITRONS

The Capacitron reputation for progressive design, superior craftsmanship and dependable service is backed by a continuous research program covering every capacitor manufacturing operation. No Capacitron production process is ever given a chance to become "standard procedure" — it is always an engineering project — always open for immediate improvement. Through this system of *method control* has come unquestioned leadership for Capacitron Oil, Wax and Electrolytic Capacitors . . . our customers call it Quality.

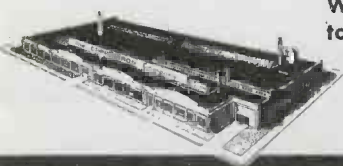

Telephone VAN Buren 3322

# The CAPACITRON Company

849 North Kedzie Ave., Chicago 51, Illinois

# BH SPECIAL TREATED FIBERGLAS SLEEVING



HEAT RESISTANT TO

1200° F!



## SNUB TEST

Proves BH Non-Fray Feature

Make this test yourself. Tap a piece of ordinary saturated sleeving on your desk top and see how easily it frays. Then do the same with BH Extra Flexible Fiber glass Sleeving. It only fuzzes a little—doesn't break down—doesn't fray.

### THE RESULT



◀ The BH Way



The Ordinary Way ▶

BH EXTRA FLEXIBLE FIBERGLAS SLEEVING

2 WAYS BETTER

NON-FRAYING • NON-STIFFENING

IF YOU NEED an electrical insulation that's not affected by temperatures up to 1200°F., yet is unusually flexible, workable and durable, you'll find it in BH Special Treated Fiber glass Sleeving. Even in direct contact with heat units this remarkable sleeving won't burn.

Reason? It's made of inorganic Fiber glass and treated by the exclusive BH process. No saturant is used, yet the sleeving won't fray when cut and it is *permanently* flexible. In addition to many other properties it is moisture, oil and grease resistant . . . works easier, simplifies assembly and lasts longer. Made in natural color only—all standard sizes. Get your free samples today and compare!

### HERE'S ANOTHER NON-BURNING SLEEVING

BH Extra Flexible Fiber glass Sleeving won't burn because both yarns and impregnation are non-inflammable. This high quality sleeving has all the advantages of pure Fiber glass, is toughened against abrasion, is non-fraying and non-stiffening. It lasts indefinitely without rotting or cracking—the ideal all-purpose electrical insulation for all kinds of industrial equipment and home appliances. Available in all standard colors and sizes from No. 20 to 5/8", inclusive. Put it to the toughest tests you know and watch the results!

ALL BH PRODUCTS AVAILABLE IN STANDARD 36" LENGTHS AND 500-FT. COILS



ALSO SLOW-BURNING IMPREGNATED MAGNETO TUBING • SLOW-BURNING FLEXIBLE VARNISHED TUBING • SATURATED SLEEVING • A.S.T.M. SPECIFICATIONS

**BENTLEY, HARRIS MANUFACTURING CO.**

Dept. I, Conshohocken, Penna.

**Simplified**

**INSULATION RESISTANCE TESTING IN INDUSTRIAL**

**Electronics**



provided by

**VIBROTEST**

**Insulation Resistance TESTER**

**ELECTRONICS**—one of the revolutionary factors in electrical industry—calls for most accurate testing of insulation resistance in most practicable form. **VIBROTEST** has long proved its dependable precision with sturdiest construction—With Synchronous Vibrators dependable for top performance—longest service. With self-contained power source, 2 No. 6 dry cells of highest quality mounted in base. (Replacements obtainable anywhere). With easiest operation. No cranking. No leveling.



**MODEL 201**  
One of 36 Vibrotest Models, covering every service.

Model 201 for general duty has a range of 0-200 megohms at 500 volts potential, 0-2000 ohms, 150-300-600 volts AC or DC. Compact, versatile, portable. Strong metal case, complete with cover and leather strap handle for carrying.

Send for complete bulletins

Ask about new Model 238 calibrated 20,000 megohms at 500 V. DC, attaining a new high in precision insulation resistance testing equipment. Also **HYPOT** insulation breakdown tester. **VIBROGROUND**, for ground resistance measurements. **VOLTAMMETER** for both A.C. voltage and amperage, etc. Research and development engineering.

Engineering Service Representatives in All Principal Cities.

**ASSOCIATED RESEARCH**  **Incorporated**

221-B South Green St.

Chicago 7, Ill.

**MODULATION PROCESSES**

(Continued from page 99)

of the small current that the transmitter can handle. Many other methods were tried, but improvements in the vacuum tube soon made it the most satisfactory modulator. The plate current of a vacuum tube is in general a rather complex function of the plate and grid voltages, but over a considerable range it can be made approximately proportional to the square of the grid voltage.

**Modulation mathematics**

Suppose such a vacuum tube were connected in a circuit as shown in Fig. 5. The input to the grid would then be  $E + A \cos pt + B \cos qt$ , and the plate current—since it is proportional to the square of the grid voltage—would be proportional to the square of this expression. Squaring of a polynomial gives the square of each term plus twice the product of each pair of terms, and since as already noticed, the product of two cosines is equal to half the sum of cosines of the sum and difference of the two frequencies involved, and since the square of a cosine can be shown to be equal to a constant plus  $\frac{1}{2}$  the cosine of double the frequency, the plate current may be written as a constant term plus

$$\begin{aligned} & \frac{B^2}{2} - \cos 2qt + 2EB \cos qt \\ & + 2EA \cos pt + AB \cos (p+q)t \\ & + AB \cos (p-q)t + \frac{A^2}{2} - \cos 2pt \end{aligned}$$

Since  $p$  is assumed to be large relative to  $q$ , the first bracket includes components much lower in frequency than those of the second, while the third bracket is of a much higher frequency. Both the first and the third brackets may therefore be readily eliminated by passing the entire output through a circuit tuned to the carrier frequency. When this is done, there remains only the second bracket, which is the modulated wave already discussed.

On rectification, such a wave yields the voice frequency, but instead of using rectification, it is also possible to derive the voice frequency by using a modulating process at the receiving end like that at the transmitting end. Because of the inverse characteristic of the result of this second modulation, however, it has commonly been called demodulation.

When the modulated wave is connected to the grid of a vacuum tube at the receiving end of a circuit, the plate current will be propor-

**10,000 PARTS**

Ten thousand different radio and electronic parts immediately available on priorities

**SERVICE**

Trained expeditors select and ship same day your order is received

**EXPERIENCE**

Known since 1922 as reliable jobbers, wholesalers and manufacturers of radio and electronic equipment

**Radio Wire Television Inc.**

100 Sixth-Ave. (Dept. N-5) New York 13, N. Y.

Boston, Mass. Newark, N. J.

World's largest Radio Supply House

Originators and Peacetime Marketers of the celebrated

**Lafayette Radio**

Write today for our bargain flyers and special bulletins

tional to its square. Here again, the result of squaring is a series of square and product terms which may be converted to the cosines of double the frequency and of the sum and difference of the two frequencies, and thus the result of squaring, omitting the constant term, is:  $[k_3 \cos qt + k_4 \cos 2qt] + [k_1 \cos 2pt + k_2 \cos 2(p+q)t + k_2 \cos 2(p-q)t + k_5 \cos (2p+q)t + k_5 \cos (2b-q)t]$  where the  $k$  constants represent various combinations of  $A$ ,  $B$ , and  $E$  of the earlier equations.

Here the components of the second bracket are all very much higher in frequency than those of the first, and may be eliminated by tuned circuits. Moreover the coefficient  $k_4$  is small relative to  $k_3$ , and thus the component of frequency  $2q$  is small relative to that of the voice frequency. The effective result will thus be the desired voice frequency.

In this explanation of modulation, it was stated that the output current of the vacuum tube was proportional to the square of the input voltage. This is merely another way of stating that the instantaneous impedance of the vacuum tube is inversely proportional to the input voltage. Since the input voltage in this case was  $E + A \cos pt + B \cos qt$ , the tube impedance is

$K$

and the output current, which is the input voltage divided by the impedance, is thus  $K [E + A \cos pt + B \cos qt]^2$ .

In general, whenever a voltage is applied across an impedance that is not constant, modulation of some sort will occur. If, for example, the applied voltage is represented by some function of voltage,  $f_1$ , and the impedance is inversely proportional to some function of voltage,  $f_2$ , and may thus be written

$K$ , then the output current is

$$f_1 \div \frac{K}{f_2} = \frac{f_1 \times f_2}{K}$$

The output current is therefore proportional to the products of two voltages, and will always include the products of cosines, and since there is almost invariably a constant term present, the results of modulation will also include one or both of the original frequencies. Other frequencies of various values may be present depending on the nature of the two functions  $f_1$  and  $f_2$ .

Modulation, therefore, is not really a simple variation of the amplitude of a single carrier frequency, but is really a form of frequency transformation. As a result of the modulation at both ends of the circuit, there will in general be produced a large number of fre-

## PORTABLE POWER PROBLEMS

THIS MONTH—TAG-HEPPENSTALL MOISTURE METER



MAJOR TOBACCO COMPANIES rely upon Tag-Heppenstall Moisture Meters, powered by Burgess Industrial Batteries, for two important time-and-money saving features. First, tests of moisture content are made to determine the purchase price of raw tobacco. Next, rapid tests during cigarette production help manufacturers maintain tobacco moisture at the level required for efficient processing.

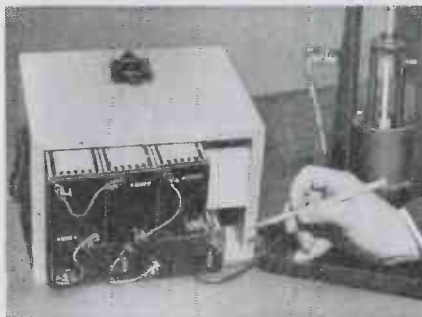

MOISTURE METER READINGS of resistance, temperature and pressure are checked against a standard chart to quickly establish exact tobacco moisture. For test and control instruments Burgess Industrial Batteries meet every requirement—they are recognized as the standard of quality for all commercial uses. Although urgent war needs limit production, your Burgess distributor will make every effort to supply you with the batteries you require.

Burgess Battery Company, Freeport, Illinois



# BURGESS BATTERIES



SUPPORT THE 7th! BUY YOUR SHARE TODAY!

Recognized as the MOST COMPLETE LINE of dry batteries

More  
Examples of  
**ACME  
TRANSFORMER  
ENGINEERING**



◆ The specially designed testing unit (illustrated above) has 140 terminals providing 70 individual secondary circuits of 2 volts each.

This radio power transformer is designed with a standard 115 volt, 60 cycle primary winding and provides a high voltage secondary winding and filament winding. Manufactured in quantity to high performance standards.



**THE ACME ELECTRIC & MFG CO.**  
Cuba, N. Y.      Clyde, N. Y.

**Acme**  **Electric**  
TRANSFORMERS

quencies, but in any usable system of modulation, the magnitudes of the various components or the separation between their frequencies must be such that the desired frequency or group of frequencies can be separated from the others by some convenient means.

A modulated wave whose envelope, after rectification, exactly reproduces the voice frequency is composed, as already shown, of waves of three frequencies,  $C$ ,  $(c + v)$ , and  $(c - v)$ . To derive the voice wave by demodulation, however, all that is needed at the input of the demodulator are two single-frequency waves whose difference frequency is equal to the voice frequency. Thus, for example, if a wave represented by  $\cos(p + q)t + \cos pt$  were demodulated, the output would be the square of this expression, and would thus include the square of both frequencies and their product. By the reduction formulas already employed, these reduce to a group of frequencies higher than the carrier and to the voice frequency. The former may readily be separated from the latter by filters.

**Single sideband**

Recognition of these facts led to the now commonly-used method of single-sideband transmission. As most widely employed, one sideband and the carrier are eliminated during or after modulation, either by the design of the amplifier or by the use of filters, and only one sideband is transmitted. This reduces the width of the frequency band transmitted to less than half of that required for double-sideband transmission, and in addition, allows all the energy transmitted to be concentrated in the one sideband, instead of having a large part of it in the carrier. The carrier required for demodulation is introduced from an oscillator of accurately controlled frequency at the receiver.

**Sylvania Marietta Plant**

Expansion of manufacturing facilities for the production of electronic products will include a new plant at Marietta, Ohio, for Sylvania Electric Products, Inc. Sylvania now has plants in over 20 towns for, although the company is one of the largest in the field, its operation is highly decentralized, with plants scattered throughout the Eastern States.

**Sound Apparatus Moves**

Sound Apparatus Co., has taken up new quarters at 233 Broadway, New York. The old address was 150 West 46th Street.

Laboratory  
Standards



**PULSE GENERATOR**

**MODEL 79-B**

**SPECIFICATIONS:**

**FREQUENCY:** continuously variable 60 to 100,000 cycles.

**PULSE WIDTH:** continuously variable 0.5 to 40 microseconds.

**OUTPUT VOLTAGE:** Approximately 150 volts positive.

**OUTPUT IMPEDANCE:** 6Y6G cathode follower with 1000 ohm load.

**R. F. MODULATOR:** Built-in carrier modulator applies pulse modulation to any r.f. carrier below 100 mc.

**MISCELLANEOUS:** Displaced sync output, individually calibrated frequency and pulse width dials, 117 volt, 40-60 cycles operation, size 14" x 10" x 10", wt. 31 lbs.

Price: \$295.00 F.O.B. BOONTON

Immediate Delivery

**MEASUREMENTS CORPORATION**

BOONTON • NEW JERSEY



# Beautifully Formed

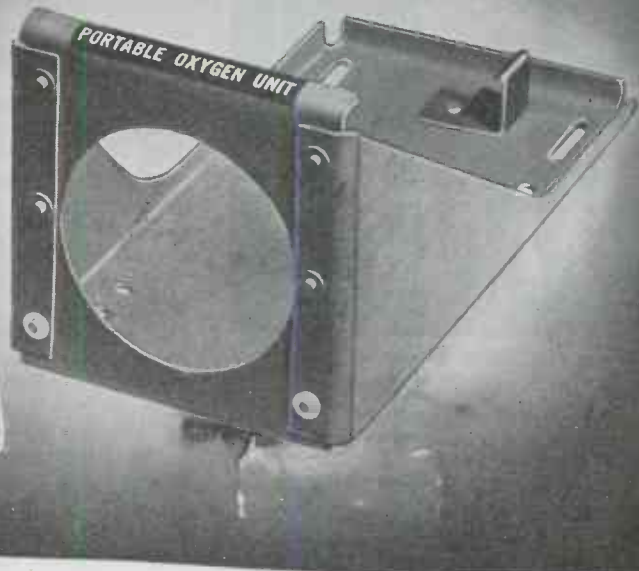

Formed in a single operation

with Post-Formed Phenolite, this portable oxygen unit support used in B-29 Super-Fortresses illustrates a revolutionary new development in laminated plastics.

## Post-Formed Phenolite\*

**Offers You New Possibilities  
for Profitable Post-War Products**

Here, through a new development in laminated phenolic plastics, a whole new avenue of applications is opened for you . . . new potentialities for successful post-war products.

Economical to produce, Post-Formed Phenolite parts are made by heating the sheet material for a few seconds and forming in an inexpensive wooden mold with standard press equipment. In a matter of minutes, practically any shape or form may be obtained—without sanding or removing "flash." Fabrication may be done before or after the forming operation.

Phenolite is light in weight (about half the weight of aluminum) . . . is an excellent electrical insula-

tor . . . has remarkable mechanical strength . . . possesses good machinability . . . and is highly resistant to moisture. This unusual combination of properties makes it a versatile material suggesting an almost endless number of industrial applications.

Now used almost exclusively for structural parts in aircraft—demonstrating its stability under varying atmospheric conditions—Post-Formed Phenolite is being supplied for important war purposes only. But, in it, you'll find countless possibilities for profitable peacetime products. Write today for further information and the assistance of one of our trained technical men in planning your post-war projects.

\*A formable thermosetting sheet material



## NATIONAL VULCANIZED FIBRE CO.

Offices in Principal Cities

Wilmington, Delaware

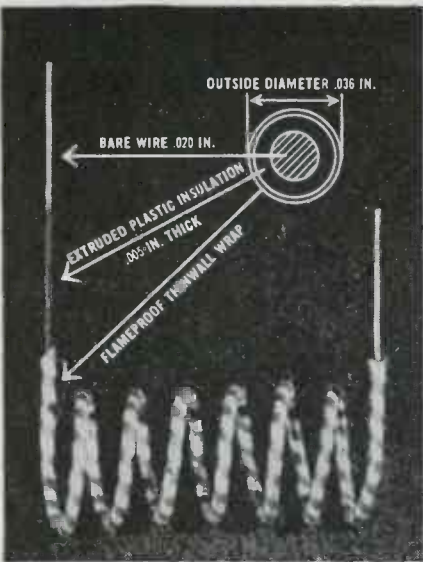

This photo of typical construction is absolutely unretouched

**Voltage Breakdown — 7000 Volts**  
(For spiraled section shown in photograph after 5 minutes in water)

Insulation Resistance—30 Megs. Per 1000 Ft. at 60° F. (After 72 hrs. in water)

**SURCO-AMERICAN**

*New*

**THINWALL WRAP**  
PLASTIC INSULATED FINE WIRE  
**UNBELIEVABLY THIN**

Surco-American Thinwall Wrap is the first uniformly high quality fine wire, with extruded plastic insulation and flame proofed yarn serving, available to industry. Surco-American Thinwall Wrap is characterized by:

- High dielectric properties
- Maximum saving in space and weight
- Unlimited coding and identification
- High temperature operation
- Excellent abrasion resistance and toughness
- Maximum protection against damage by soldering iron
- Unusual flexibility at below freezing temperatures
- Flameproof qualities
- Good end and spot-stripping characteristics
- Low cost

Surco-American Thinwall Wrap is available in a wide variety of formulations finer sizes of wire and thinner insulations than shown above, for use where maximum performance under specific operating conditions is required.

**Surprenant**  
ELECTRICAL INSULATION CO.  
Dept. O 84 Purchase St., Boston 10, Mass.

**MAGNETRON FREQUENCIES**

(Continued from page 106)

dus a. This leads to the general equation:

$$\lambda = Ca^2H/V.$$

The numerical values for the constant C are approximately:  $C_1 = 700$  for the first oscillation with longer wavelength, and  $C_2 = 400$  for the other oscillation. These values for the constants apply to all four-segment magnetrons regardless of their dimensions.

Identical relations were established for the two-segment magnetron with the constants  $C_1 = 1700$  and  $C_2 = 1100$ .

Oscillations at the longer wavelength ( $\lambda_1$ ) are more stable in frequency and intensity than those of the shorter wavelength ( $\lambda_2$ ). The maximum deviations of the measured values from those calculated by the above equation is 5% for ( $\lambda_1$  and 15% for ( $\lambda_2$ ).

Both oscillations start, with the aperiodic load circuit, at a magnetic field approximately double the critical magnetic field and can still be observed for a magnetic field of 3100 gauss, the highest field used, though the anode current at these high field strengths is less than  $1\mu A$ . A wavelength range of from 1 m. to 19 m. is covered. For a Lecher wire load circuit not at resonance with the magnetron oscillation, the oscillations started at a magnetic field of approximately 1.3 times the critical field; if the Lecher wire system is at resonance with the oscillation, its start coincides with the critical magnetic field.

Occasionally harmonics of both oscillations were observed. In some instances, a third frequency with a still shorter wavelength could be

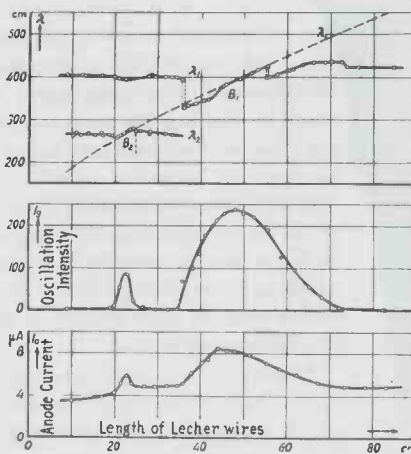

Fig. 4—Wavelength, oscillation intensity and anode current as function of length of Lecher wires:  
Four-segment magnetron, emission current 38mA,  $r = 0.5$  cm.,  $H = 1825$  gauss,  $V = 800$  volt

**For SOLDERING ECONOMY and EFFICIENCY**



**ESICO SOLDERING IRONS**

Designed for tough, long-lasting factory service. Widely used in industrial plants everywhere.

**ESICO SPOT SOLDERING MACHINE**



A real time-saver. Treadle-operated. Automatically advances iron and solder, leaves operator's hands free for work.

**ESICO SOLDERING IRON CONTROLS**



Positive TIP control prevents over-heating — tip cannot fall below soldering temperature. The only practical method of controlling heat in the tip — an exclusive ESICO feature!

**ESICO SOLDER POTS**



Rugged construction. Variety of sizes. Designed for continuous non-stop operation. Elements replaced easily and quickly.

FOR nearly two decades, ESICO has stood for superb quality and over-all economy in soldering equipment. The name ESICO on your soldering tools is definite assurance of long, uninterrupted service. Specify ESICO — the name that assures you of satisfaction.

Write Today for Complete Information On the Esico Line



**ELECTRIC SOLDERING IRON CO. Inc.**  
2145 West Elm Street, Deep River, Conn.

detected; the associated constants were  $C_3 = 460$  for the two-segment magnetron and  $C_3 = 300$  for the four-segment magnetron. Because of its small intensity this oscillation was not investigated more fully.

The independence of the wavelength of the resonant oscillation from the external load circuit is demonstrated by the top diagram in Fig. 4. The wavelength remains substantially constant with the exception of the two regions  $B_1$  and  $B_2$  where the Lecher wire system is at resonance with the generated oscillation; the dashed line ( $\lambda_0$ ) indicates the resonance wavelength of the Lecher wire system. It will be seen that the two curves for ( $\lambda_1$ ) and ( $\lambda_2$ ) show the known behavior of coupled resonant systems, the magnetron oscillations taking the place of the primary system and the Lecher wires that of the secondary system.

### Oscillation intensity

The oscillation intensity (second diagram in Fig. 4) has a maximum for resonance, as is to be expected for coupled circuits. Also, the anode current shows a considerable increase in the resonance region (third diagram in Fig. 4). Here the resonance regions are wider and the increase of anode current is higher for the two-segment magnetron than for the four-segment magnetron, indicating stronger coupling.

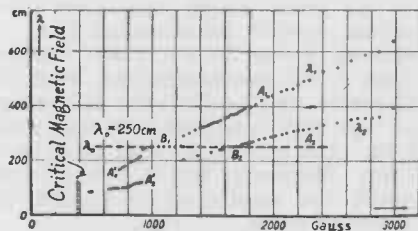
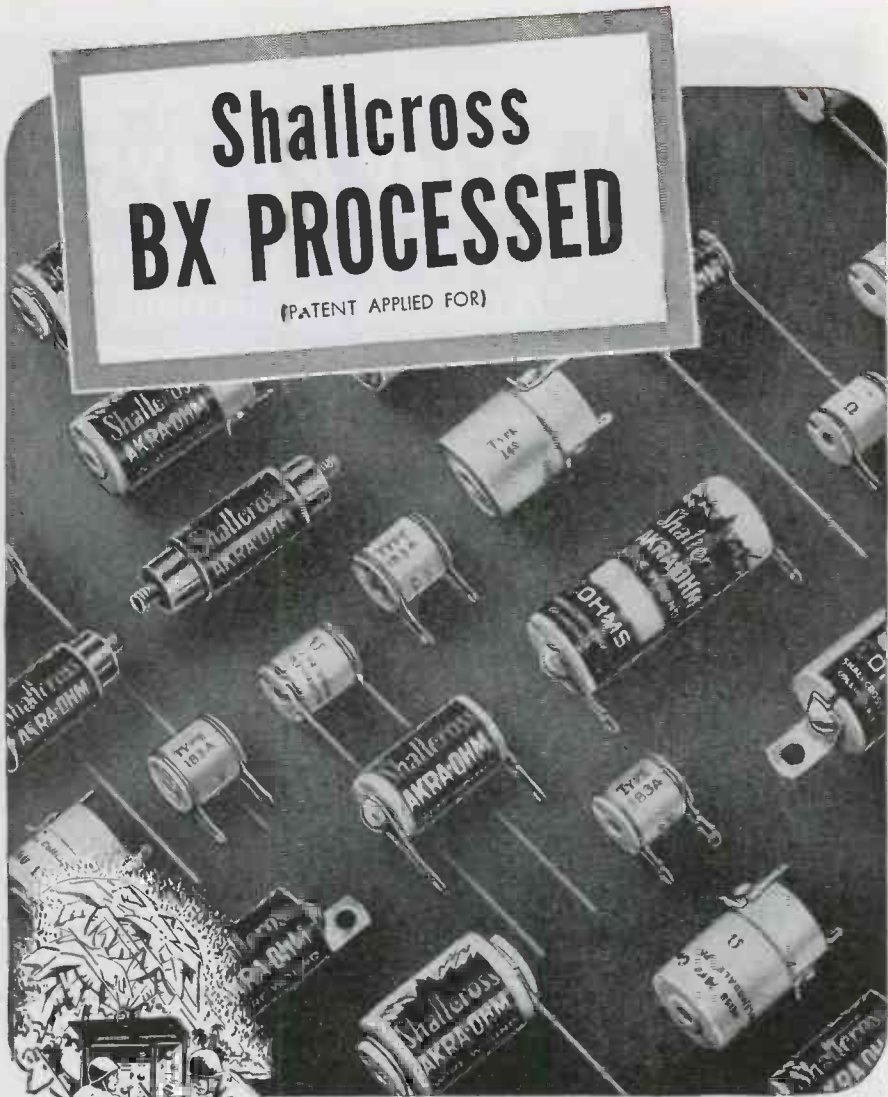

Fig. 5—Wavelength of function of magnetic field intensity:

Four-segment magnetron,  
emission current 147mA,  
 $r = 0.5$  cm.,  $V = 800$  volt

Corresponding resonance and coupling phenomena are also observed for the wavelength-magnetic field relation when the Lecher wires are of constant length, Fig. 5. Comparison of this diagram with Fig. 2 for the aperiodic load circuit shows a maximum difference in the inclination of the straight lines of 15%. It may be concluded that the presence of the resonance circuit influences the generated wavelength to a slight degree, even though it is not at resonance with the oscillations.

The influence of the angle of tilt (angle between magnetic field and cathode) and of the emission current intensity were also investigated and discussed.



## HIGHLY RESISTANT TO MOISTURE AND FUNGUS

Applicable to Any Akra-Ohm Type

**BX Processing** for Shallcross Akra-Ohm Close Tolerance Wire-Wound Resistors is the culmination of extensive specialized engineering research in close conjunction with the exacting demands of the nation's armed forces.

**ANTI-FUNGUS TEST**—Exposed in actual outdoor conditions in which the known fungi were numerous and under an average relative humidity of 95%, no fungus or corrosion was apparent after 88 days.

**SALT SPRAY**—Large users have certified that BX Resistors successfully withstand 200 hours of salt spray containing 20% sodium chloride.

**HUMIDITY**—Production samples supplied to a leading manufacturer's laboratory successfully withstood 90 days exposure to 90% relative humidity at a temperature of 85° F. Measured while wet, at the end of the test, the resistors were still within a few tenths of one percent of their original value!

**TEMPERATURE CYCLING**—Five cycles of -55° C. to +85° C. have no effect on the coating or stability of BX Processed Resistors—a fact confirmed by impartial tests in several large industrial laboratories.

Shallcross BX Processed Resistors are identified by the prefix "BX" on the standard type number. Write for details.

# SHALLCROSS MFG. CO.

DEPT. EI-55, COLLINGDALE, PA.

ENGINEERING • DESIGNING • MANUFACTURING

**AMPERITE**

**THERMOSTATIC METAL TYPE  
DELAY RELAYS  
PROVIDE DELAYS RANGING  
FROM 1 TO 120 SECONDS**

Other important features include:—

1. Compensated for ambient temperature changes from -40° to 110°F.
2. Contact ratings up to 115V-10a AC.
3. Hermetically sealed — not affected by altitude, moisture or other climate changes . . . Explosion-proof.
4. Octal radio base for easy replacement.
5. Compact, light, rugged, inexpensive.
6. Circuits available: SPST Normally Open; SPST Normally Closed.

WHAT'S YOUR PROBLEM? Send for "Special Problem Sheet" and Descriptive Bulletin.

**AMPERITE CO.** 561 BROADWAY  
NEW YORK 12, N. Y.  
In Canada: Atlas Radio Corp., Ltd.  
560 King St. W., Toronto



**C. T. C. TURRET  
TERMINAL LUGS**



**For Firm,  
Quick Fastening,  
Swift Soldering  
Terminal Posts**

Just swage them to the terminal board and you have strong, well anchored terminal posts. Two soldering spaces permit wiring of two or more connections without superimposing wires. Soldering is swift because sufficient metal is used in Lugs to provide strength,

but there's no surplus metal which would draw heat and thus slow soldering.

Made of heavily silver plated brass, C.T.C. TURRET TERMINAL LUGS are stocked to fit 1/32", 2/32", 3/32", 4/32", 6/32" and 8/32" terminal boards.



Write for C. T. C. Catalog No. 100



**CAMBRIDGE THERMIONIC CORPORATION**  
441 Concord Avenue • Cambridge 38, Mass.

**DESIGN OF ELECTRONIC  
HEATING GENERATORS**

(Continued from page 111)

So far, we have neglected the power losses in the circuit. These can be kept low by increasing the physical size of the circuit components. However, this is not the complete answer; for example, take the case of the applicator coil in an induction heating equipment. This coil is of copper. Assume that the work to be heated is also of copper. When the work is cold there will be as much power lost in the applicator as in the work. Therefore, the maximum possible efficiency is 50 per cent.

In induction heating circuits, the measured, overall efficiencies from tank to load run from 90 per cent for a steel load and closely coupled system, to around 40 per cent for a large copper load. As a matter of fact, there is no lower limit to the efficiency since it depends so directly upon the size and type of the load. For a load such as small copper wire the efficiency may be one per cent or less. For this reason it is very difficult for manufacturers to rate their products on a basis of power output. About the best that can be done in this line is to give the output rating of the generator when working into an ideal load.

**Generator considerations**

Let us say that a generator is to be built which will have the rather special requirement that it deliver 50 kw to a certain copper load. By measurements with a Q-meter we find that the efficiency of the best practical coupling system, tank circuit-to-load is 40 per cent. Moreover, the Q of the tank when the applicator is loaded, is found to be 75.

Since the efficiency is only 40 per cent, the power fed to the tank circuit must be 50/40 or 125 kw. This then is the value of P which must

be put into the formula  $P = \frac{EI}{Q}$

Thus  $EI = 125 \times 75$  or 9375 kva. If the rms voltage impressed on the tank circuit is to be 10 kv then the

current will be  $\frac{9375}{10}$  or 938 amps.

Therefore the impedance of each limb of the circuit will have to be  $\frac{E}{I} = \frac{10,000}{938}$

$Z = \frac{10,000}{938} = 10.6$  ohms.

At a frequency of 400 kc the tank capacitor must have a capacity of approximately .04  $\mu$ f. Moreover, it must be capable of handling 1000 amperes at 10,000 volts rms. Such a condenser would cost between \$3000 and \$5000.

Compare this cost with that of a



# ALL 5

## USE THIS STANDARDIZED INTERPHONE SYSTEM

For the first time radio and interphone control systems have been completely standardized for more than one type of aircraft ... by Pacific Division. Altair Model LY-10A system is being used on the Lockheed *Ventura*, Martin *Mariner*, Consolidated-Vultee *Catalina* and *Privateer* and the Douglas *Skymaster*. Designed to Navy specifications by Bureau of Aeronautics and Pacific Division engineers, this is a complete system to control all communication and radio navigation equipment in large aircraft.

This feature alone is recognized as an important step forward in aircraft accessory design. Model LY-10A, however, incorporates — also for the first time — the use of isolation amplifiers which eliminate all crosstalk without the use of multiple audio output stages in each receiver. Selection of up to 9 receivers and 3 transmitters at flight deck stations can be provided.

Altair Model LY-10A, which provides a simple control for a large number of complex radio units, is an example of Pacific Division's understanding of a job that could result only from long experience. Pacific Division invites inquiries on any radio problem.

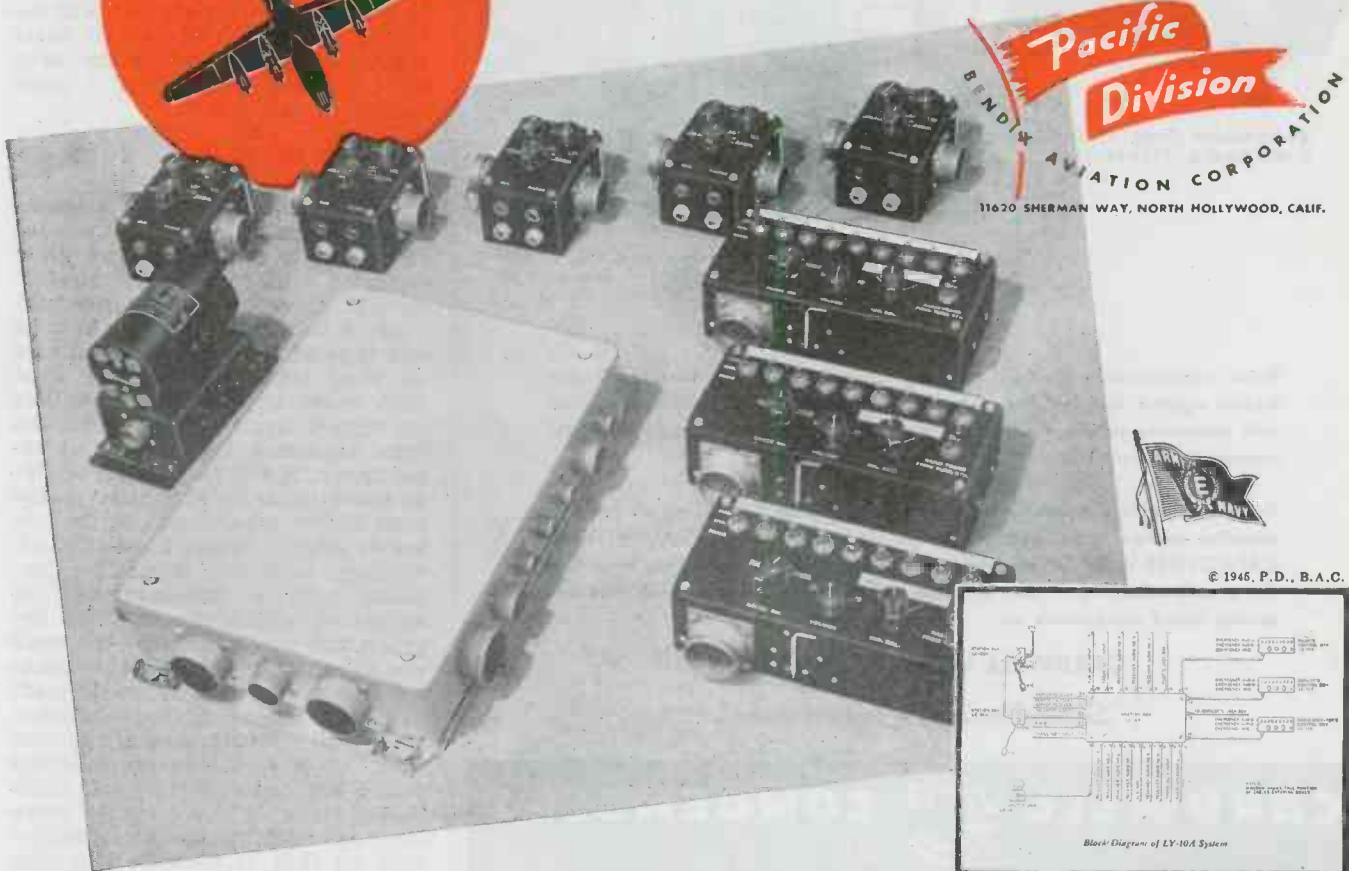

**Pacific Division**  
BENDIX AVIATION CORPORATION  
11620 SHERMAN WAY, NORTH HOLLYWOOD, CALIF.



© 1945, P.D., B.A.C.

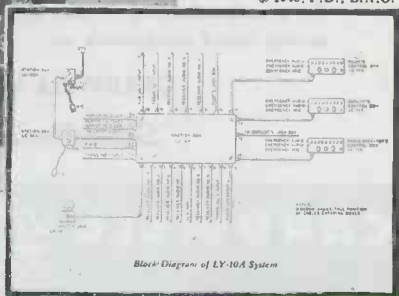

**PACIFIC DIVISION, Bendix Aviation Corporation, 11620 Sherman Way, North Hollywood, California.**  
Sales Engineering Offices: Lincoln Building, New York City 17; Continental Building, St. Louis 8.  
ELECTRONIC INDUSTRIES • May, 1945

# Why

# CARDWELL CAPACITORS

mean

*"Safety at Sea"*



Radiomarine Corp. ET-8019  
S.W. Radio Transmitter

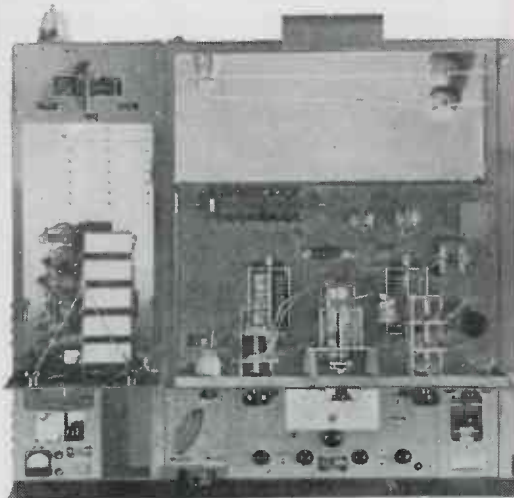

Radiomarine Corp. ET-8023  
S.W. Radio Transmitter

Radio communication links our far-flung merchant fleet with all possible protection against disaster. The importance of immediate and reliable contact with protective service facilities of our Navy and Coast Guard, in critical emergencies, is obvious.

The Radiomarine Corporation of America, specialists in building all types of essential marine radio equipment, specified CARDWELL TRANSMITTING CAPACITORS in the two representative designs pictured here. They know that the overall reliability of their products depends on the use of such time and service tested components as

## CARDWELL QUALITY PRODUCTS

*"Standards of Comparison"*

# CARDWELL CONDENSERS

THE ALLEN D. CARDWELL MANUFACTURING CORPORATION  
31 PROSPECT STREET BROOKLYN 1, N. Y.

.005  $\mu$ f condenser which could be used in a circuit to deliver 50 kw to a steel load. The other parts of the low impedance circuit would also be much larger and more costly.

Therefore, when a designer sets out to build a 50-kw generator, he must first decide just what his customers are going to want; whether they want low cost equipment which will deliver its rated power to an ideal load, or whether they are willing to pay the extra cost necessary to put that power into high-Q loads. Even then he is faced with several alternate design policies.

### Coupling methods

(1) Probably the cheapest method is to use a rather loose coupling throughout, together with a relatively high-inductance applicator coil and a provision for tuning the applicator accurately so that with a steel load the tank Q will be reduced to 15 or 20.

(2) Another method which has the advantages mentioned previously, is to use close coupling throughout, with circuit constants so adjusted that with a steel load of nominal size the  $Q_1$  will be 15 or 20 without additional tuning. In both these schemes, when the load is a high conductivity material, the actual power output will be a fraction of the rated value. This is to be expected since a high-Q load or applicator arrangement will result in a tank Q of two or three times the value for which the oscillator was designed. That is, since the power output is

$$P = \frac{EI}{Q} = \frac{E c \omega}{Q}$$

where E is limited by the tube design, a value of Q higher than the 15 or 20 for which the circuit was designed will result in a proportionate decrease in power output.

(3) A third alternative is to build one type of tank circuit to be used on steel loads and another type, with lower impedance, to be used on high-Q loads. Since this latter type requires a larger value of capacitance, it will necessarily be two or three times as expensive as the tank circuit which is to be used on low-Q loads. It will have this advantage, however: it can be provided with a simple device by means of which the coupling between the applicator and the work can be greatly decreased, thus making it possible to heat low Q-loads without overloading the oscillator.

(4) Still a fourth method involves the use of a tuned or partially tuned, applicator. But, as was mentioned formerly in a footnote, when the applicator has a low impedance such as that of a single loop, the tuning capacitor becomes a major problem. Such a condenser should have a capacitance in the order of

# For Television Transmission

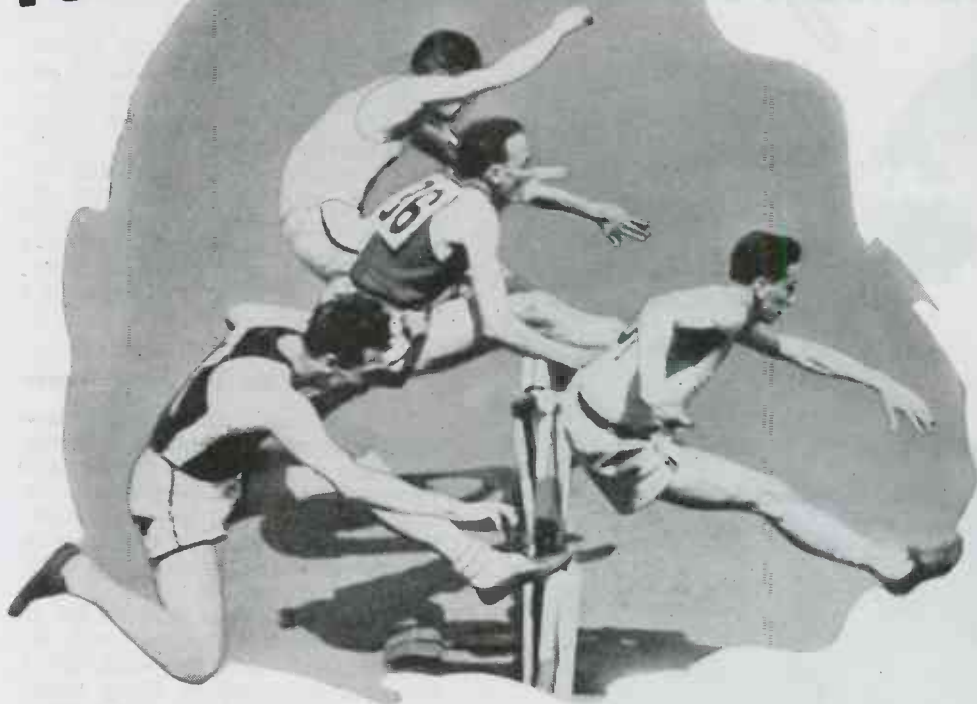

... count on

## Western Electric equipment to lead the way!

Just as soon as final Victory opens the door to post-war progress in television, Western Electric plans an active program of development work as well as manufacture of television transmitters. In this field, as in sound broadcasting, you can be sure of advanced design and highest quality equipment engineered by Bell Telephone Laboratories and made by Western Electric.



Buy all the War Bonds you can . . . and keep all you buy!

### BACKGROUND FOR LEADERSHIP IN TELEVISION



Back in 1927, Bell Labs and Western Electric transmitted black and white images over wire circuits and also by radio.



In 1929, the first public demonstration of full-color television marked another advance by Bell Labs and Western Electric.



Here is a fanned out section of the latest type of Western Electric coaxial cable—destined for an important place in television networks.



Development work by scientists of Bell Labs will lead to more pioneering advances in television for tomorrow.

# ANDREW

## Rhombic Transformers



★ LOW LOSS

★ BROAD BAND RESPONSE

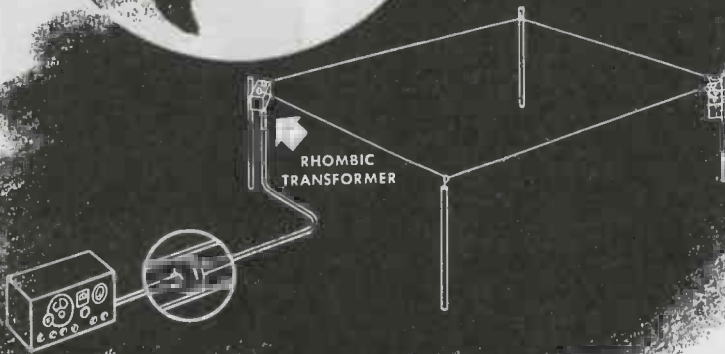

### FOR TRANSOCEANIC RADIO COMMUNICATION

★ You need *quality* equipment for reliable, uninterrupted radio communication across oceans and continents. That is why radio engineers specify ANDREW antenna coupling transformers and coaxial transmission lines when designing rhombic antenna systems.

For highest efficiency and most successful rhombic antenna operation, the antenna coupling circuit must have a broad frequency response and low loss. To meet these requirements, ANDREW engineers have developed the type 8646 rhombic antenna coupling transformer, illustrated below, to assure fullest utilization of the advantages of the rhombic type an-

tenna. Losses are less than 2 decibels over a frequency range from 4 to 22 megacycles.

Type 8646 unit transforms the 700 ohm balanced impedance of the antenna to match the 70 ohm unbalanced impedance of the line. Unusually broad band response is achieved by using tightly coupled transformer elements with powdered iron cores of high permeability. This unit is contained in a weatherproof housing which may be mounted close to antenna terminals.

Transformer unit 8646 is another expression of the superior design and careful engineering that has made ANDREW CO. the leader in the field of radio transmission equipment.

WRITE FOR BULLETIN NO. 31 giving complete information on this new radio communication unit.



## ANDREW CO.

363 EAST 75th STREET  
CHICAGO 19, ILLINOIS

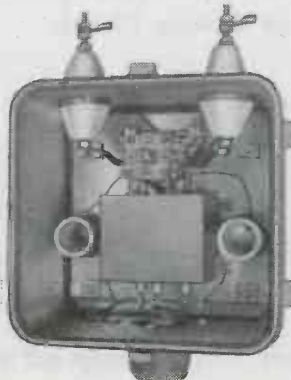

one microfarad and should be capable of carrying currents in the order of 1000 amperes at 1000 volts. It should also be of minimum size.

The method in general makes use of closely coupled circuit which is designed to furnish rated power when the tank Q has a value of about twenty. This will handle most of the steel work without additional tuning. Then for those cases in which the load is of a high conductivity material or in which the coupling from applicator-to-work is necessarily loose, the applicator is given some capacitive reactance. This effectively reduces the Q of the applicator and thereby causes the tank Q to take on a usable value.

#### Tuning capacitance

In some cases the "tuning" capacitance must be added in series with the applicator, in others it is necessary to add capacitance in parallel. However, in the majority of applications it is purely a matter of convenience which connection shall be used.

To make a simple analysis let us say that we wish to use such an arrangement; that the work has a value of  $Q_w$  equal to 10 or more, and that we wish to use the capacitance in parallel with the applicator.

The circuit is shown in Fig. 4. It will be noted that this circuit is similar to that shown in Fig. 2 with the exception that a capacitor  $C_A$  is connected in parallel with the applicator inductance  $L_3$ . The values of  $K_1$ ,  $K_2$ ,  $L_2$ , and  $L_3$  are the same as those used before, but  $Q_w$  will be taken as 10. Whenever  $Q = 10$  we may, without much error, replace  $Z_w^2$  with  $L_w^2 \omega^2$ . This simplifies the mathematics somewhat. Also let us introduce a term  $m$  to represent the ratio of the capacitive reactance of  $C_A$  to the inductive reactance of  $L_3$ .

The curves of Fig. 5 show how  $Q_2$  and  $Q_1$  vary with the impedance ratio  $m$ . A value of  $m = 1.5$  reduces the value of  $Q_1$  from a normal 61 to a usable 24 under the assumed conditions. If the coupling between the applicator and the tank circuit is loose (say  $K_1 = .33$ ) even though the work has a  $Q_w$  as low as 5,  $Q_2$  is approximately 2.97 and  $Q_1 = 70$  when  $m = 1.5$ . Even in the completely tuned condition (when  $m = 1$ ),  $Q_2 = 4$  and  $Q_1 = 29$ . Of course these latter figures are not accurate because of the assumption that  $Q_w > 10$  in the derivation of the equations. They do serve to show, however, that the less the coupling the more accurately the applicator must be tuned to reduce the tank Q to a practical value. But the partial tuning scheme is not the complete answer since as yet there are no condensers on the market which





**QST-1**—Life testing\* is an important Quality Standard test of United. It is a strictly observed procedure whereby life expectancy is controlled in "run-of-production" tubes.



**QST-2**—A unique test is applied to every United tube to assure noise-free operation.

# Who sets the *Quality Standard* FOR TRANSMITTING TUBES

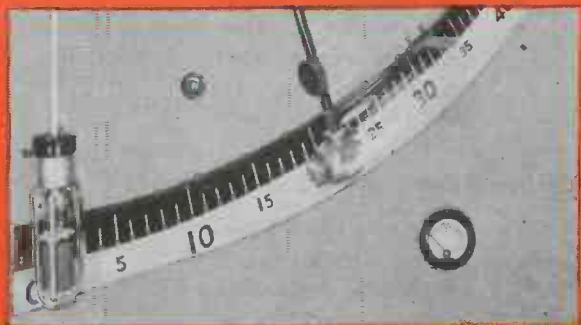

**QST-3**—United tubes designed for very rough service have extra, built-in shock resistance proved by the severe Bump Test each tube must pass.

**\* Quality Standard Test.**

Brilliant United craftsmanship is steadfastly verified and maintained by skillful and vigilant testing—truly representative of daily production. For this reason every United tube must pass through a series of critical examinations that do not permit any defects, no matter how minute they may be, to escape unnoticed.

By maintaining Quality Standard Tests of the highest order United engineers and technicians have

achieved recognition for leadership. To engineers everywhere, the name United is the *trusted* standard by which other transmitting tubes are judged and measured.

For every electronic application including radio communication, physiotherapy, industrial control and electronic heating, standardize with tubes that are the Quality Standard. "Tube up" with United.

Order direct or from your electronic parts jobber.

*Masterpiece of  
Skilled Hands*



# UNITED

**ELECTRONICS COMPANY**

NEWARK, 2



NEW JERSEY

Transmitting Tubes **EXCLUSIVELY** Since 1934

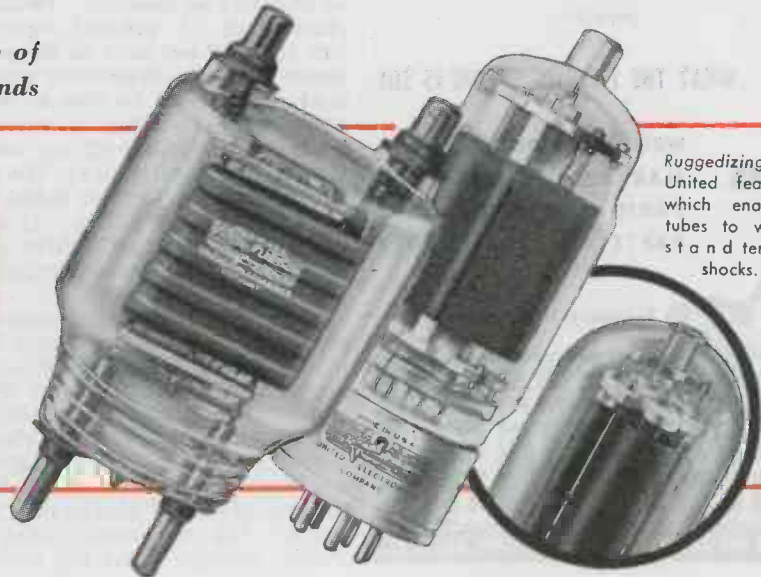

**Ruggedizing:** A United feature which enables tubes to withstand terrific shocks.

hrc

# The News About HARVEY is going 'round



## Purchasing Agents are saying:

If we need tubes, meters, capacitors, resistors, test equipment, or any other radio and electronic components, what do we do? We call HARVEY—he has 'em!

## Wartime Agencies are saying:

If HARVEY can't furnish us with the parts we need, he finds them for us — or gives us something that will fill the bill.

## Training Schools are saying:

... and besides, we get extra service from his staff. They know the ins and outs of this priority business, and know how to cut through red tape.

## Laboratories are saying:

HARVEY delivers! No time lost on the orders we send to him. That place has good, efficient service.

## WHAT THE FIELD IS SAYING IS SO!

**WRITE, WIRE OR TELEPHONE  
HARVEY FOR CRITICAL  
RADIO AND ELECTRONIC  
PARTS AND EQUIPMENT!**

Telephone: LOnacre 3-1800

**HARVEY  
RADIO COMPANY  
HARVEY  
103 WEST 43rd ST., NEW YORK 18, N. Y.**

meet the necessary specifications of the tuning capacitor.

### Ideal generator

Let us consider now what might be the essential features of an "ideal" hf power generator. To be practical only those qualities which have some chance of attainment will be discussed. In the first place, the equipment should be of minimum size physically, since space on a production line is the highest price real estate in the world. However, compactness will have to be balanced against accessibility.

Although electronic equipments can be expected to give more trouble-free service than most other types of complicated machinery, power tubes do have to be replaced occasionally. The replacement of such tubes should require only a matter of minutes since time, too, may be a very dear commodity. Therefore, easy accessibility is very important in the ideal generator.

Another plan by which the minimum space requirement can be achieved is by breaking up the generator into two or more parts. Of course, such an expedient is necessary only in the case of the larger equipments. However, for sets above the 25-kw size, this separation into parts may become quite desirable. The power transformers may be at one location, perhaps outside the plant; the rectifier tubes and controls may be at another point; the power tube and its controls should be within a few feet (less than 30) of the point of power application. The only apparatus which must be at the assembly line position is the tank circuit and applicator. (In some equipments only the output transformer and applicator are at the working position.)

### Electrical requirements

As to electrical requirements; the ideal generator should of course be as efficient as possible. (Maximum efficiencies of present equipment run from 50 per cent to 65 per cent plate-to-work—depending upon the load.) It should be able to feed its power into as wide a variety of loads as possible with an absolute minimum of adjustment. The power tube should develop its rated power on a low plate voltage. If a tube could be made to yield large powers on 440 volts it would enormously simplify our designs.

The ideal generator should be completely safe to personnel. Interlocks should be provided so that power is automatically shut off and those parts which have been at high potential grounded, whenever access is gained to the high-voltage circuits. Circuit breakers and interlocks should also be provided to protect the equipment from accidental damage. But the matter of

# Co-ordination

A NEW ROLE FOR  
**SIGMA RELAYS**



The 5 RPL relay has two coils with separate terminals which may be connected to independent pilot circuits. The load of the relay is operated only by the co-ordination of the two pilot circuits. This may be the sum or the difference of the pilot circuit voltages depending on the polarity of coil connections.

The same result can be accomplished with the unmounted type 5 F relay but the enclosed form is usually preferred. Both types are widely used in aircraft applications where circuit co-ordination is desired.

**SIGMA**

**Sigma Instruments, Inc.**

*Sensitive RELAYS*

70 Ceylon St., Boston 21, Mass.

providing safety devices to protect equipment should be studied from the standpoint of cost of insurance; that is, the cost of the equipment protected, likelihood of damage, time lost in replacement, etc., should be taken into consideration. Throughout the whole design the guiding lights must be simplicity and low cost.

The controls should, if possible, be only those which control output power, time, "on" and "off." In most set-ups only an "on" and an "emergency off" should be available to the operator. A single meter or pilot light to show normal operation is all the instruments the operator needs; all other control operations should be automatic. When tuning is necessary it can be made automatic and some modern equipments are provided with automatic tuning or impedance-matching devices. These are especially useful in equipments which are used for dielectric heating.

In summary, it can be said that the designers of hf heating equipment are faced with problems very similar to those met by Edison and others who developed the dc and low frequency generators. Some scheme of standardization will have to be worked out and generators developed along predetermined lines. Perhaps a system of standardized outputs will be developed so that applicators can be built which will work efficiently on any hf generator having the specified characteristics for which the applicator was designed. Certainly many problems of the designers will be eliminated as plans of recognized procedure are established by manufacturers and users of high frequency industrial generators.

### **Radio's War Effort**

\$161,752,000 was the value of time on the air and performers' services provided by United States radio stations, networks and radio advertisers for delivering war messages to the public in 1944, according to the National Association of Broadcasters. This represents an increase of 8% over the volume of 1943 messages. Radio advertisers contributed \$64,000,000 of this amount. Stations and networks provided \$78,000,000, while performers' services for all three are estimated at \$20,000,000.

### **Benwood Linze in New York**

The Benwood Linze Electrical Mfg. Co., with headquarters in St. Louis, has opened a New York office at 420 Lexington avenue. H. S. Dahl will be in charge of the office.



*No. 2 of a Series*

## MODERN COIL WINDINGS on bobbins

Three bobbins are being wound in sequence, which results in a minimum unit coil cost and maximum production.

*May we help you with  
your war production  
problems?*

**COTO-COIL CO., INC.**

CO - SPECIALISTS SINCE 1917

65 PAVILION AVE.

PROVIDENCE 5, R. I.

# SPARE PARTS BOXES

Made as per specification—42 B 9 (Int) for shipboard use,  
Electrical and Mechanical. Navy grey finish.  
Immediate Delivery.

No. 1025-1  
12" x 6" x 6"



24 STOCK SIZES			
Number	Length	Width	Height
1025-1	12	6	6
1025-2	12	9	6
1025-3	12	12	6
1025-4	12	9	9
1025-5	18	9	6
1025-6	18	9	9
1025-7	18	12	9
1025-8	18	6	6
1025-9	18	15	9
1025-10	18	12	6
1025-11	18	15	12
1025-12	18	12	12
1025-13	18	18	12
1025-15	24	15	12
1025-16	24	15	15
1025-17	24	18	12
1025-18	24	18	15
1025-19	24	18	18
1025-20	24	12	9
1025-23	30	15	9
1025-14	30	15	12
1025-22	36	12	9
1025-21	42	9	9
1025-24	42	12	9

WRITE FOR PRICE LIST

No. 1025-11  
18" x 15" x 12"  
(Partitions extra)



**Cole Steel**  
**office equipment**

will again be available  
after the war

# COLE

STEEL EQUIPMENT COMPANY

349 Broadway, New York 13, N. Y. Factory: Brooklyn

## WIDE READING

(Continued from page 112)

responds to a converging mirror.

If the potential of the center electrode, *c*, is made still more negative, the electrons are deflected further in front of the lens center, ray 3. These electrons are subjected to a field having a component in the direction away from the lens axis; a diverging electron mirror is obtained.

### Mirror microscope

Investigations on the behavior of an electron microscope incorporating a diverging mirror instead of a projection lens were carried out. In the experimental model, Fig. 2, the projection system could be, alternatively, connected as a lens or as a mirror. Provisions were made to view or photograph the images for comparison.

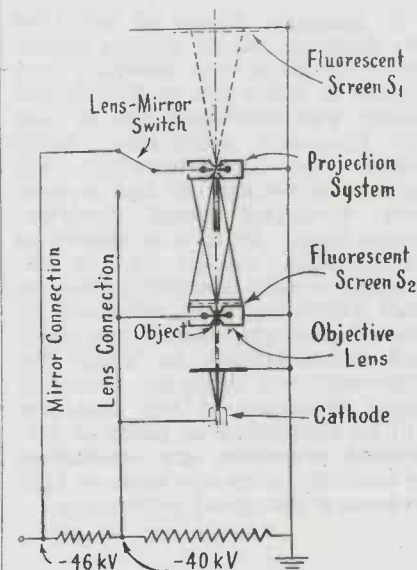
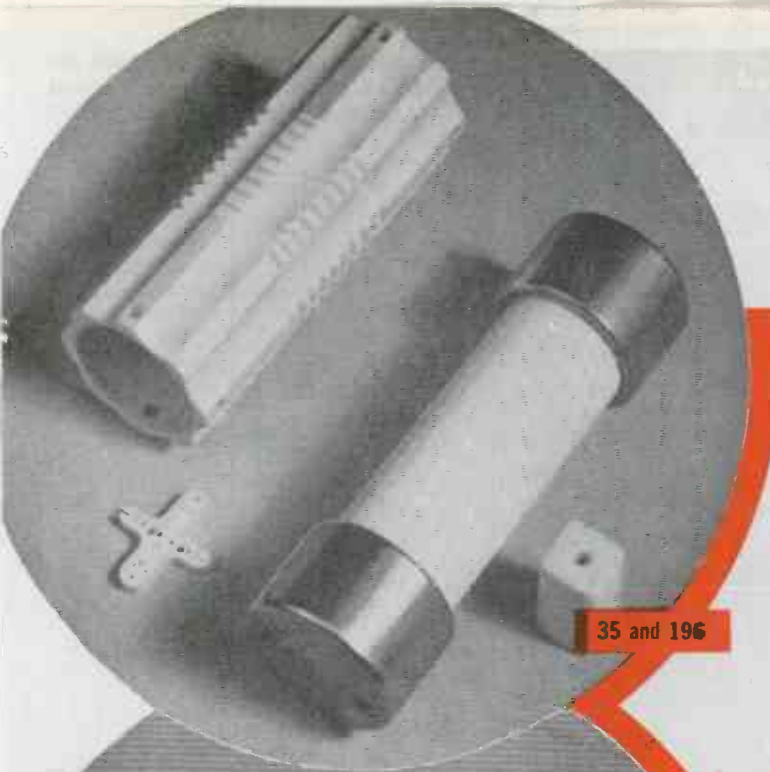

Fig. 2—Experimental model having alternative lens and mirror connections

With the lens connection of the lens-mirror switch, the electrons proceed past the projection system and produce an image on fluorescent screen *S*<sub>1</sub>, as in conventional microscopes. With the mirror connection, however, the electrons will be reflected by the projection system and impinge against fluorescent screen *S*<sub>2</sub>. Screen *S*<sub>2</sub> and the photographic material mounted behind it are provided with holes in the center to permit passage of the electron beam emerging from the objective lens. The focal length of the objective lens used was 3.5 mm and that of the diverging projection mirror 2.7 mm.

### Table electron microscope

Fig. 3 shows a table microscope based on the mirror design illustrated in Fig. 2. Fluorescent screen *S*<sub>1</sub> for the observation of the inter-



35 and 196



197



72 and 202

## THE ALSIMAG CERAMICS

ALSiMAG is the trade name of a wide variety of ceramic bodies, each with its own particular physical and electrical characteristics. Among those finding widest applications are the following:

**ALSiMAG 35 and 196** Possessing high mechanical strength combined with low electrical loss at high frequencies, these bodies are ideally suited to most electrical and electronic applications.

**ALSiMAG 197** Good mechanical strength and resistance to high temperatures for sustained periods make ALSiMAG 197 especially valuable in the field of electrical heating devices.

**ALSiMAG 72 and 202** Low co-efficients of expansion, coupled with ability to withstand thermal shock, make these materials desirable in combustion tips and thermo-couple insulation.

Whatever you are planning in the electronic or electrical field, we believe our specialized knowledge, experience, constant research and development will be helpful. Let's work together.

**AMERICAN LAVA CORPORATION**

*Chattanooga 5, Tennessee*

43RD YEAR OF CERAMIC LEADERSHIP

# ALSiMAG

TRADE MARK REG. U. S. PAT. OFFICE

## CERAMICS

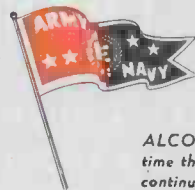

*ALCO has been awarded for the fifth time the Army-Navy "E" Award for continued excellence in quantity and quality of essential war production.*

Case Dimensions Closely Checked

Spot Welds Tension Tested

Plating Quality Acid Tested

# QUALITY CONTROL The Case Tests

Careful control of quality in essential parts is good insurance for smooth flowing production and for a high calibre product.

Thus Deep Drawn, Seamless Steel Cases, an essential part of many Chicago Transformers, are subjected to precision checks for case dimensions, pull tests for strength of spot welds in internal mounting structures, and inspection for electro-plating thickness with carefully timed acid erosion.

By this type of Quality Control, applied in every phase of manufacture, uniformity of parts is maintained and high standards of quality in finished Chicago Transformers is assured.

# CHICAGO TRANSFORMER

DIVISION OF ESSEX WIRE CORPORATION

3501 WEST ADDISON STREET

CHICAGO, 18



TRADE MARK REG.



mediate image can be observed on a metal mirror which is viewed through the window. Fluorescent

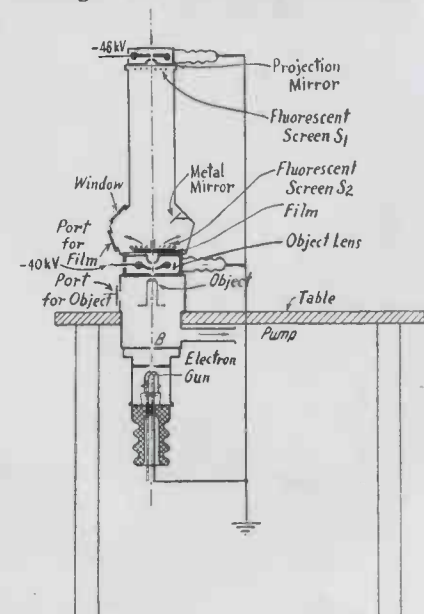

Fig. 3—Electron-mirror microscope mounted on table

screen  $S_2$ , which is visible directly through the window, consists of two sections mounted rotatably in the direction of the arrows to uncover the photographic material mounted behind the screen.

Two photographs, represented in the original article and showing the same metal surface taken with the lens and the mirror connection, respectively, indicate about equal performance of the two types. The enlargement ratio is 1:17,000; object distances of 15 to 20  $m\mu$  can be distinguished.

## Microanalysis by Means of Electrons

J. Hillier and R. F. Baker (Journal of Applied Physics, September 1944).

The energy losses suffered by a free electron upon the collision with atomic electrons have discreet values corresponding to the energies required to remove the atomic electrons from their respective shells in the atomic structure. It is proposed that the constituent elements of microscopic particles be identified by this specific energy loss, or the associated retardation of velocity, of the transmitted electrons.

The device designed for this purpose includes some means for selecting for the analysis only those electrons which have been transmitted by a desired particle, as well as means for measuring electron velocities over a sufficient range.

An electron probe having an extremely narrow velocity distribution is made to produce a shadow image of the specimen indicating the area from which transmitted electrons will be velocity analyzed.

# POWER TUBE ANODES

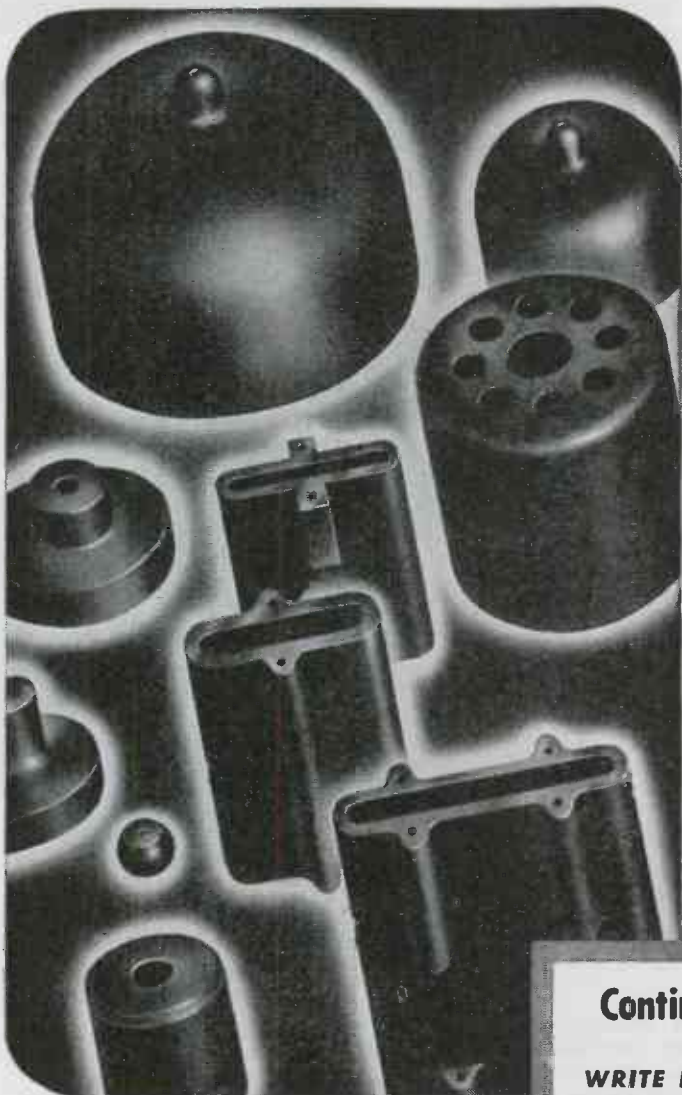

## Standard or Special Types



Stackpole Power Tube Anodes are "tailor-made" for the specific tube type involved. Whether your need is for a standard type or something new for a tube type that has never been made before, Stackpole engineering is well equipped to serve you. Years of experience throughout the entire and highly ramified power tube field are your assurance of the closest possible match to your specifications—or samples which may enable you to set a new, higher standard for your present anode specifications.

**STACKPOLE CARBON COMPANY**  
St. Marys, Pa.

## STACKPOLE

**ELECTRICAL BRUSHES and CONTACTS**  
(All carbon, graphite, metal, and composition types)

**RARE METAL CONTACTS**

**WELDING RODS, ELECTRODES and PLATES**

**BRAZING BLOCKS**

**RHEOSTAT PLATES and DISCS**  
**PACKING, PISTON and SEAL RINGS**

**CARBON REGULATOR DISCS**  
**SINTERED IRON COMPONENTS**

**CARBON PIPE, etc.**

## Continuously Adjustable Carbon Rheostats (CARBON PILES)

**WRITE FOR  
THIS NEW  
BOOKLET**

Based on processes made available to meet the war emergency by the Morgan Crucible Co. of London and its American affiliate, the Morganite Co., Stackpole carbon and graphite disc piles have been developed in an extensive line holding important engineering possibilities for applications heretofore reserved for rheostats of other, but less satisfactory, types. Write for new Bulletin.

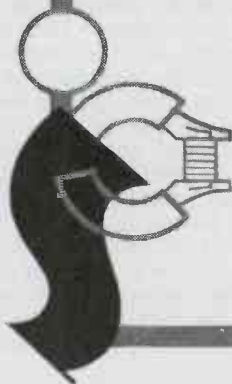
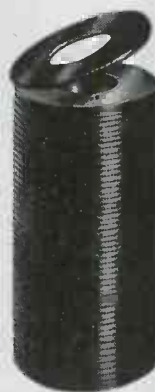

# STACKPOLE

**"EVERYTHING IN CARBON BUT DIAMONDS"**



## FLEXIBILITY ...in meeting your problem

Does a special part for the product you make present a problem in design—in materials—in costs? Call on our consultant service for help—no obligation to you. Our engineering experience and our modern machines are both geared to flexibility in the manufacture of cold-forged specialties. In most cases, moreover, at a saving in costs to you.



This Decimal Equivalents wall chart is accurate to four places and signalled in three colors. Yours at no cost or obligation. Just send us your name, title and address.

See our Catalog in Sweet's File for Product Designers

**JOHN HASSALL  
INC.**

Specialists in Cold-Forging  
Since 1850

412 Oakland St.  
Brooklyn 22, N. Y.



The same electron probe simultaneously provides the electrons which, upon passage through the specimen, are velocity-analyzed in a homogeneous magnetic field. The performance of the apparatus is considered in detail and results obtained with beryllium, aluminum, silicon, iron and zinc are reported.

### Supersonic Measurement of Metal Thickness

W. S. Erwin (Iron Age, November 9, 1944).

The Sonigage, developed in the Research Laboratories of the General Motors Corp. in Detroit, is an instrument designed for measuring the section thickness of metal parts where the inner surface is not accessible, as for instance in hollow steel propeller blades. The method is based on determining the frequency at which the metal is set into resonant vibrations in the thickness direction. Since the product of the resonant frequency and the thickness is equal to one-half the velocity of sound, which is a constant for any given material, the frequency measurement indicates the thickness.

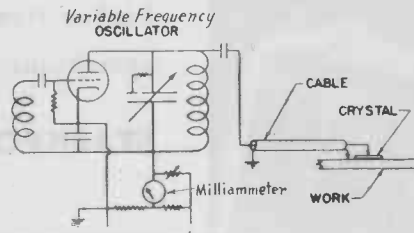

Measuring thickness of metal sheet if one surface is inaccessible

The instrument consists of the variable frequency oscillator and the quartz crystal shown in the drawing. Variations in the no-load current encountered in the oscillator frequency range are compensated by the special loading plate on the tuning capacitor. Due to internal damping of the metal, power is required to maintain the thickness vibration and this power is a function of frequency. Tuning of the oscillator and simultaneous observation of a milliammeter in the plate circuit permits determination of the resonant frequency with an accuracy of one per cent. The thickness of metal sections in the approximate range of 0.020 in. to 0.400 in. can be measured with a maximum error of less than 2 per cent.

### High Vacuum Gages

M. Pirani and R. Neumann (Electronic Engineering, London, December 1944, January, February, March 1945).

In a survey article on high vacuum gages which gives a systematic report of the various principles employed for measurement of low pressures as well as of their appli-



● Try DALIS "KNOW-HOW" to avoid those expediting headaches. Here's an outstanding stock of radio-electronic parts, materials, equipment—at your call!

And DALIS has the well-trained organization, long experience and exceptional factory connections that deliver hard-to-get items in a hurry. A dependable source of supply since 1925. An indispensable source, today.



Try DALIS — just wire,  
'phone or write ...

**H. L. DALIS**

Wholesale Distributors  
RADIO-ELECTRONIC SUPPLIES & PARTS

17 Union Square  
NEW YORK 3, N. Y.

Phones: ALgonquin 4-8112-3-4-5-6-7



cation in actual apparatus, several electronic vacuum gages are described and discussed. An extensive bibliography accompanies the text.

Electronic vacuum gages are based on the measurement of the number of positive ions present which is proportional to the pressure. The number of positive ions in the tube is determined by the current to a negative collector electrode.

### Recording Electrostatic Fields

A. D. Ehrenfried (American Journal of Physics, December, 1944).

A device has been developed for rapid, automatic plotting of equipotential points in an electrostatic field; field configurations produced in a trough of water may be traced. The unit is being successfully used to plot electron-lens fields, flux distribution around armature teeth, and the fields within vacuum tubes, enlarged models being used for field electrodes.

A table supports the light-sensitive paper over the water trough, and a C-shaped arm, which rides on the table, carries an exploring probe and a plotting light mounted directly over the exploring probe. An electronic switch turns on the plotting light whenever the exploring probe is at the potential of a fixed selector probe. Thus, by zig-zagging the exploring probe in the vicinity of the equipotential line chosen by the selector probe, a series of points forming the desired equipotential curve is photographically recorded.

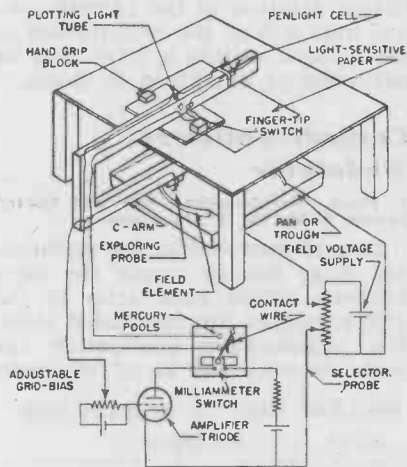

Apparatus for plotting equipotential lines

A contact wire is attached to the needle of a milliammeter, and two mercury pools are so located under the needle that the wire can brush through them, simultaneously closing the plotting light circuit. The milliammeter is connected in the plate circuit of an amplifier whose cathode is at selector probe poten-

*The Standard of Quality for a Third of a Century*

# HICKOK

## Instruments that tell the truth..



Volt-Ohm-Milliammeter



All-Purpose Tube and Set Tester



Signal Generators



Oscillograph

● In maintaining the highest standard of excellence the one and only HICKOK aim must always be the building of instruments that tell all the truth all the time. When quality is built up to a high standard instead of down to a price, the user has greater confidence in his work.

Whether you are selecting tube and set testers, signal generators, oscillographs, volt-ohm-milliammeters or any other service equipment, remember that the standard of quality for a third of a century has never been excelled. Having pioneered the major new developments and vindicated maximum accuracy and dependability, HICKOK equipment has been specified by the armed forces in both world wars. We are still bending every effort to speed the war program and trust it will not be long until we can again take care of your civilian needs with the service equipment that is held in highest esteem. Write for Radio Equipment catalogue.

**THE HICKOK ELECTRICAL INSTRUMENT COMPANY**  
10528, Dupont Ave., Cleveland 8, Ohio

# MOTOR DATA

No. 129



## 4000 FRAME MOTOR

1/2 HP at 3900 RPM

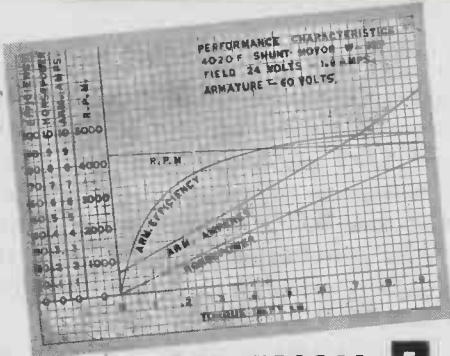

The output—the weight—the size—of these 4000 Frame Motors are features well worth remembering. Every adaptation of the standard design is engineered for the precise requirements of an aircraft, portable, or industrial application.

### ELECTRICAL

- Series, shunt, or compound-wound
- Unidirectional or reversible
- Optional torque
- Optional speed
- Optimum efficiency
- For control circuits
- Electric braking optional

### FEATURES

### MECHANICAL

- Ventilated or enclosed types
- Base or flange mounting
- Operation in any position
- Low space factor
- Ball bearing equipped
- Optional shaft details
- Rugged construction

4000 FRAME MOTORS		4020 Shunt	4020 Series
Watts, Output, Con. (Max.)		375	746
Torque at 3900 RPM	(ft. lbs.)	.65	1.4
Torque at 6000 RPM	(ft. lbs.)		.88
Speed Regulation		8%	
Lock Torque	(ft. lbs.)	2.5	4
Volts Input	(min.)	12	24
Volts Input	(max.)	110	110
Diameter		4"	4"
Length Less Shaft		7 1/8"	7 1/8"
Shaft Dia.	(max.)	.625"	.625"
Weight	(lbs.)	9.2	9.2

**EICOR INC.** 1501 W. Congress St., Chicago, U. S. A.  
 DYNAMOTORS · D. C. MOTORS · POWER PLANTS · CONVERTERS  
 Export Ad Auriema, 39 Broad St., New York, U. S. A. Cable Auriema, New York

tial. The grid bias is so adjusted that when the exploring probe and the selector probe are at the same potential, the plate circuit positions the contact wire across the mercury pools.

The plotting light bulb is inserted in a tube which is closed by an opaque disk containing two adjacent pin holes. This plotting light aperture permits points of one equipotential line to be distinguished from those of another by adjustment of the slant of the double-dots upon rotation of the enclosing tube.

### Remote Control System

C. G. Grant and J. H. Collins (Post Office Electrical Engineers' Journal, London, October, 1944).

The problem was to set up a remote control system for a teleprinter broadcast switchboard. Two separate broadcasts originating from a station in the country could be given simultaneously, and either or neither broadcast could be connected to any of a group of 40 stations. Originally the material to be broadcast was collected and retransmitted from a London station where the switching system to select the receiving stations was located and controlled.

To avoid the necessity of retransmitting the broadcast, a remote control system was installed to permit operation of the switching system located at the London station from the transmitter station. Connection between either of the transmitters and a selected group of the 40 receiving stations could now be effected at the transmitter station; alternatively the control at the London station was available. The circuit diagram of the remote control unit and of the switchboard in the London station is given and its performance explained in detail.

### Cathode-Follower Modulator

F. Below (Hochfrequenztechnik und Elektroakustik, Berlin, Vol. 61, June issue).

In grid modulation, the modulating stage has to supply the large currents which may arise in the grid circuit of the modulated stage. For square-wave modulation the grid currents may be of the order

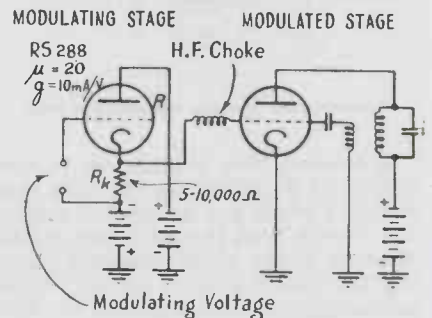

Cathode follower modulator

# NATIONAL RECEIVERS ARE THE EARS OF THE FLEET

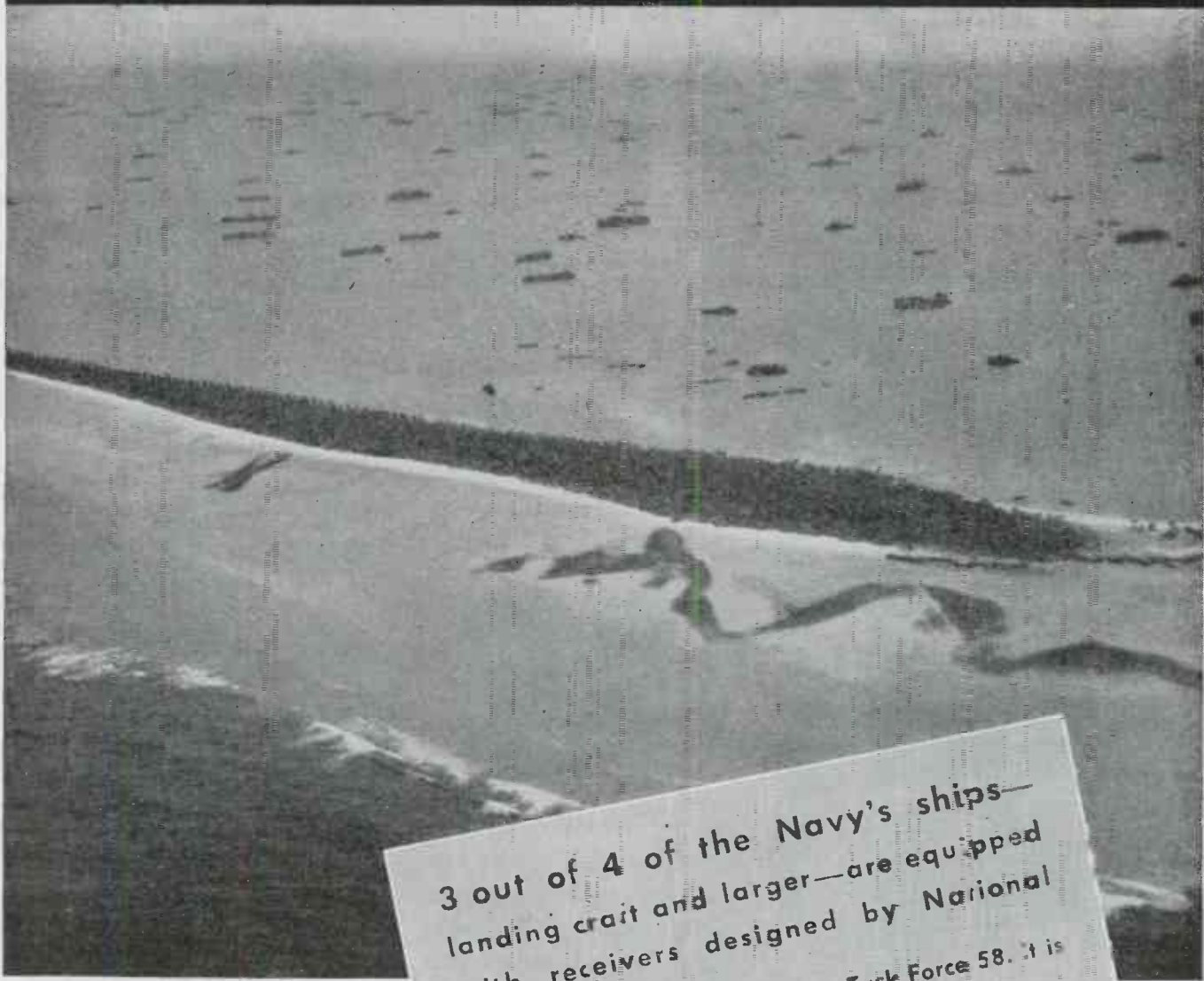

OFFICIAL U. S. NAVY PHOTOGRAPH

3 out of 4 of the Navy's ships—  
landing craft and larger—are equipped  
with receivers designed by National

This is a small part of mighty Task Force 58. It is  
more than a lot of ships and a lot of men, it is an  
integrated striking force of terrific power. Radio  
communications have played a vital role in the  
operations for which Task Force 58 has become  
famous.

We are proud that National radio receivers are a  
part of this Force.

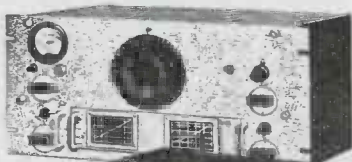

HRO

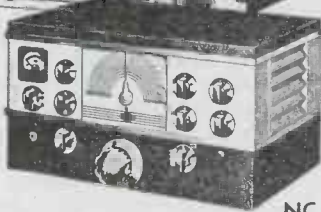

NC-200

## NATIONAL COMPANY

MALDEN



MASS., U. S. A.

NATIONAL RECEIVERS ARE IN SERVICE THROUGHOUT THE WORLD



# GREEN

## A ball player's ball player . . .

. . . that's the kind of player other players admire. Moving over from the ball field to the field of rectifiers, there

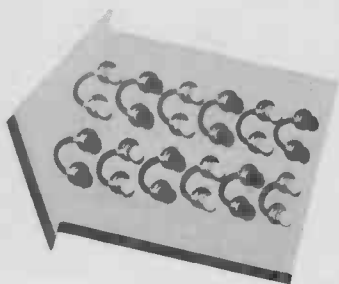

are the versatile Green Rectifier Engineers who've won the admiration of topflight companies with DC problems. General Motors and Bethlehem Steel, for example, choose Green rectifier units, and that makes us kind of happy. The orders that send our spirits soaring are those that come from companies whose engineers *know* rectifiers, *and they include . . .*

### THE MULTI-RECTIFIER MR1

This unit incorporates six selenium rectifier sections which may be quickly interconnected by external links to provide four different ranges of DC power:

- 0-8 volts, maximum capacity . . . . . 100 amperes
- 0-16 volts, maximum capacity . . . . . 50 amperes
- 0-24 volts, maximum capacity . . . . . 35 amperes
- 0-48 volts, maximum capacity . . . . . 18 amperes

On any range, the two panel-mounted voltage control switches offer a range of control in 49 steps, from zero to maximum.

### THE MR2

has double the ampere capacity of MR1 on each range. Otherwise identical with MR1.

WESTERN ELECTRIC • SYLVANIA • ECLIPSE-PIONEER • UTAH • DeJUR-AMSCO  
NATIONAL UNION • CROSLY • R.C.A. • PILOT RADIO • HOWARD RADIO  
BELL TELEPHONE LABORATORIES • FEDERAL TELEPHONE AND RADIO • BENDIX  
TELERADIO • STROMBERG-CARLSON • GENERAL ELECTRIC • WESTINGHOUSE

We can design and build rectifier units to solve *your* DC problem—any voltage—any current—any application.

**"Rectifier Engineering is our Business"**



SELENIUM • ARGON • MERCURY VAPOR • GRID CONTROL • HIGH VACUUM • XENON

**W. GREEN ELECTRIC COMPANY, INC.**

SELECTRO-PLATERS AND ALL TYPES OF RECTIFIER EQUIPMENT

GREEN EXCHANGE BUILDING 130 CEDAR STREET NEW YORK 6, N. Y.

RECTIFIER  ENGINEERS

of one ampere. With dynamic coupling, see figure, the cathode-follower used as the modulating tube is capable of supplying these large grid currents without an appreciable decrease in the cathode potential and, consequently, in the dc grid bias of the modulated tube. As soon as the oscillator grid current drives the cathode of the cathode follower more negative, its plate current increases. This is equivalent to the statement that the greater part of the oscillator grid-current flows through the cathode-follower tube and does not affect the cathode potential.

### Limiting Stable Electron Current

J. R. Pierce (Journal of Applied Physics, October, 1944).

The limiting current beyond which homogeneous, one-dimensional electron flow is unstable is considered, assuming the electronic charge to be neutralized by the presence of positive ions. For parallel planes across which  $V_0$  volts are applied and which are a distance of  $L$  cm apart, the limiting current density in amperes/cm<sup>2</sup> is equal to  $104 \times 10^{-6} V_0^{3/2}/L^2$ . For a long conducting tube capped by grids on both ends, the limiting current in a direction parallel to the axis is equal to  $160 \times 10^{-6} V_0^{3/2}$ . These limiting currents are roughly 6 times as great as in the absence of ions.

### FACSIMILE TODAY

(Continued from page 120)

means that a Saturday Evening Post story in Saturday Evening Post type, of 5,000 words, could be put into the homes within your service area in five minutes, or a 60,000 word book could be put there in an hour if you wanted to run it that fast.

"It can do that particular thing at relatively low cost, and it can do it on a standard AM broadcast channel or a standard FM broadcast channel. Thus facsimile becomes a part and, to my mind, a very important part of the FM growth which we all anticipate.

"What, then, is needed to start facsimile broadcasting services rolling? Probably the most important thing is standardization. The second thing that is necessary is FCC action with respect to the rules under which facsimile broadcasting may be carried on. The third thing that is necessary is the release by the War Production Board of manpower and materials.

"The standardization is well under way. Recommendations as to the channeling and form of regulations are well under way, and you know as much about when the War



# Cathode Ray Tubes For War and Post-War

**A**MONG the many types of tubes produced by North American Philips for war purposes is the 5-inch cathode ray tube illustrated here. The problem with this type tube was to produce it in volume with evenly coated screens having no pinholes or other defects.

The ability to produce, in volume, NORELCO cathode ray tubes that meet rigid specifications, is the result of experience gained by an organization with a background of over half a century of research and development in the electrical field.

Although NORELCO tubes now go to our armed forces, a list of tube types we are especially equipped to produce will be sent on request.

North American Philips will have post-war facilities available for the development and production of tubes for projection television; also amplifier, transmitting, rectifier and special purpose tubes.

Write today for interesting booklet on "How and Why Cathode Ray Tubes Work" and the brochure describing the background of North American Philips in the science of electronics.

• When in New York, be sure to visit our Industrial Electronics Showroom.



**Norelco** Electronic Products by

OTHER PRODUCTS: Quartz Oscillator Plates; Searchray (Industrial X-ray) Apparatus, X-ray Diffraction Apparatus; Medical X-ray Equipment, Tubes and Accessories; Tungsten and Molybdenum Products; Fine Wire; Diamond Dies.

**NORTH AMERICAN PHILIPS COMPANY, INC.**

Dept. D-5, 100 East 42nd Street, New York 17, N. Y.

Factories in Dobbs Ferry, N. Y.; Mount Vernon, N. Y. (Metalix Div.); Lewiston, Me. (Elmet Div.)

Designed for



Application

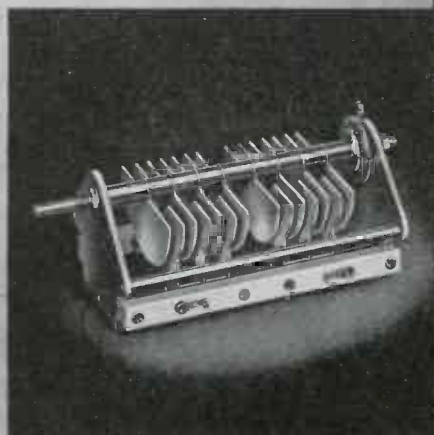

### 16000 Series

#### Transmitting Condensers

A new member of the "Designed for Application" series of transmitting variable air capacitors is the 16000 series with peak voltage ratings of 3000, 6000, and 9000 volts. Sturdy construction, thick, rounded, polished aluminum plates with 1 3/4" radius. Constant impedance, heavy current, multiple finger rotor contactor of new design. Available in all normal capacities in single and double sections.

**JAMES MILLEN  
MFG. CO., INC.**

MAIN OFFICE AND FACTORY  
**MALDEN  
MASSACHUSETTS**



Production Board will release materials and men as I do.

"With respect to those standards, it might interest you to know that WELD made a survey of something like 1,600 users of facsimile, people who had actually seen it in operation as it was prewar.

"Of those 1,600, something like 90 per cent said they would like to have facsimile if it were faster, if it contained visible recordings, if it had a four-column format, 8 in. wide, let us say—four 2-in. columns. All of those things and more have now been provided by the growth of facsimile development, and there is no reason to worry about making them available to the public from a technical point of view.

"The probable standards which, as in television, will make it possible for any facsimile recorder to receive broadcast facsimile from any facsimile transmitter, may well call for 9-in. paper in a continuous roll revolving or feeding through the machine and writing down programs in 4-column format.

"The definition will probably be about 100 lines per inch, possibly a bit higher, but those 100 lines per inch permits the reproduction of newsprint, and while it is easier to read than it is to read newsprint in the newspaper, it is adequate. The chances are that facsimile programs will be put out on a somewhat larger type basis, possibly 10-point instead of 6- or 7-point that is common in newspapers.

"The speed is likely to be from 32 to 40 sq. in. per minute, which would correspond to about 600 to 800 words of text per minute. That is higher than the average reading speed of about 300 words per minute; but since it takes less time to absorb pictures than it does text, it may well be a good plan to have its actual paper speed higher than is necessary for text alone."

### International Communications

The Navy, as represented by its secretary, James B. Forrestal, wants a single "chosen instrument" to handle all international radio communications. The Army is definitely against the proposition; Federal Communications Commission favors it but with limitations. According to the Navy plan, a corporation to be run by 20 directors, five appointed from the government and 15 from private business, would be created to handle all international communications, be they broadcast point-to-point, press or what have you. In advancing the proposal, Secretary Forrestal pointed to the fact that other governments operate under monopolistic principles. He believes that the United States might well do so for reasons of expediency and efficiency.



## DO YOU NEED A *Neutralizing Condenser* FOR 45,000 VOLTS BREAKDOWN?

Here it is! With one inch spacing and rounded edges on all adjacent parts; this new type TN condenser has a capacity range of 33.1 to 12.6 mmf. Rough adjustment of capacity is made by moving the outer cylinder within the clamp. Precision settings covering a total range of 12 mmf are secured by rotation of the tuning control shaft which comes out at an angle of 90° to the lengthwise axis of the condenser. The location of this shaft may be changed radially in steps of 45°. The 12 inch scale shown in the above illustration will indicate the approximate dimensions.

A smaller model is available, having a voltage breakdown rating of 35,000 peak volts and a capacity range of 26.0 to 7.2 mmf. Both models can be supplied with larger capacity ratings if desired: Spun and cast aluminum are used in the construction of both models. Connections are made direct to the aluminum castings and leads may come off at any angle. The Johnson line includes a complete range of sizes of similar condensers down to the model N-125, rated at 9,000 peak volts Breakdown.

Write for further information.



**JOHNSON**  
*a famous name in Radio*

F. Johnson Co. Waseca, Minn.

ELECTRONIC INDUSTRIES • May, 1945

## COLD CATHODE OSCILLOGRAPH

(Continued from page 92)

eye. In order to observe the beam on the screen, the target must be taken out of its path by turning the target knob.

The cathode ray starts out in a direction perpendicular to the surface of the cathode: the position of this surface depends upon a more or less crude adjustment controlled by the lateral knobs at the cathode assembly. The optimum condition exists when the core of the cathode passes through the center of the anode opening. This will result in the brightest obtainable and most uniformly round image on the screen. To obtain this, a magnetic cross field, generated by the "upper deflecting coils" is sometimes utilized as a vernier to the mechanical adjustment.

After optimum alignment has been obtained, the ray must be focused by means of the lower focusing coil. When this coil is energized and the current adjusted for best concentration, the spot may shift somewhat from its original position. This shift is caused by a small lateral field component set up by this coil below the central aperture; it does not affect the adjustments made at the upper part of the instrument.

### Adjusting beam intensity

The upper focusing coil needs be used only when highest beam intensity is required. The adjustment of the upper coil current is best made while the lower coil is de-energized. Raising the current will increase the brightness and size of the spot on the screen and also may shift it from its original position. This shift must be compensated for by the action of the upper deflecting coils which are to be controlled suitably step by step while the concentration coil current is increased so as to keep the ray in its original location. After optimum setting is obtained, the lower coil is also brought into action. The latter, however, will now no longer be able to focus the beam to such a sharp spot as obtained without the upper coil.

Phenomena of about 1 to 20,000 microseconds duration can be recorded on stationary film. The time axis of the stationary film is about 3 in. long. However, if the phenomenon lasts longer than 2,000 microseconds, better resolution is obtained by using the rotating film drum which carried a film 18 in. long and has a maximum speed of one inch per 500 microseconds (7,000 rpm).

A rotating film drum carries a fast moving film, which provides a range of recording that lies be-

# FROM THE HOUSE OF JACKS

... and other radio and electronic components!

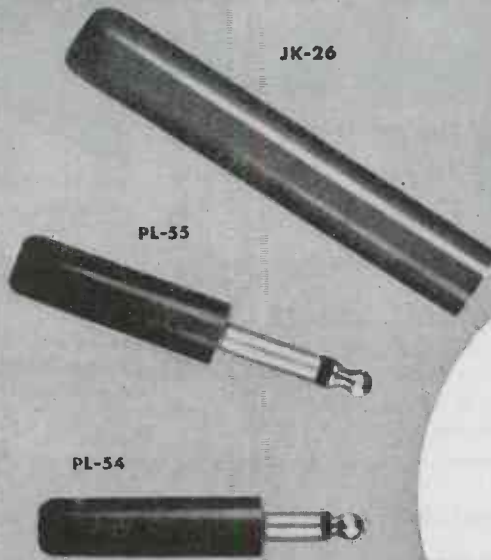

America's largest producer of JK-26 jacks. All models built to strict Signal Corps specifications.

### Experience for Sale!

Amalgamated Radio, pioneers in the field, maintain experimental and development laboratories for post-war radio and television equipment. Our components are completely engineered in a self-contained factory equipped with tools of our own design. Years of specialized experience assure high quality products, at low cost. Inquiries are invited.

ADDITIONAL JACKS & PLUGS FOR IMMEDIATE DELIVERY  
JK-55 JK-48 PL-291 PL-291A PL-204

## AMALGAMATED RADIO TELEVISION CORP.

476 BROADWAY • NEW YORK 13, N. Y.

## What Time Operations

are you controlling or wish to control

### ELECTRICALLY?

Advise us and our Engineers will forward you the proper interesting Bulletin covering this particular case, free of obligation.

We specialize in this subject

Unquestionably we can streamline this equipment to look better—do a more efficient job—be more accurate and reduce your expense.

Write today for one of these interesting Bulletins.

**The R.W. CRAMER COMPANY Inc.**  
(Electrical Timing Headquarters)  
CENTERBROOK CONNECTICUT



# VACUUM TUBE VOLTMETER

RF — AC — DC

The result of  
10 years of Vacuum  
Tube Voltmeter  
Engineering.

## MODEL VM-27

1-3-10-30-100 volts full scale.  
Peak response, r.m.s. calibration.

HIGH IMPEDANCE—4 megohms at 50 cycles, 60,000 ohms at 100 megacycles. 7 megohms for d-c.

ACCURATE—Better than 2 percent on d-c and 60 cycles thru 50 megacycles.

SELF-CONTAINED—115 or 230 volt 50-60 cycle line operation.

## RF PROBE

Interchangeable probe included for convenience and efficiency in making AC and RF measurements. Input capacity 5 micro farads. Ruggedly mounted 6H6 tube in balanced circuit. Complete voltmeter with probe \$150 net f.a.b. Flushing, N. Y.

## ALFRED W. BARBER LABORATORIES

34-04 Francis Lewis Blvd.

Flushing, N. Y.

IMMEDIATE  
DELIVERIES

### ACCESSORIES

To increase VM-27 range to 1000 volts.



### 10X AC MULTIPLIER MODEL ACM-27

Input impedance even greater than probe alone. Flat response from 20 cycles to 200 megacycles. \$17.00 net f.a.b. Flushing, N. Y.



### 10X DC MULTIPLIER MODEL DCM-27

5 megohms input resistance. \$8.00 net f.a.b. Flushing, N. Y.

### Rotating film drum

For other film speeds, a rotary inverter is used where the rotating film drum must be held at a constant speed over a wide range, up to 7,000 rpm. A 110 to 125-volt dc source is needed for the inverter required to operate the rotating film drum above 3,550 rpm. The inverter changes dc into ac of variable frequency which drives the film drum three phase, 2-pole induction motor at corresponding speed.

In the recording of power circuit phenomena, it is not undesirable to have the record on the film drum extend over several revolutions. The resulting oscillograms are easily analyzed despite the overlapping of lines. In the recording of phenomena of more irregular pattern, such as encountered in ignition circuits, it is desirable to have the film exposed for only one revolution. This is accomplished by the "Single Revolution Exposure Control."

The voltage which is to be measured—or a selected portion of it—must appear at the deflecting electrodes 1 and 2 of the oscillograph tube. Unidirectional voltages up to 2,000 or oscillatory voltages up to a 1,200 crest can be measured directly. Higher voltages must be reduced by suitable means. Resistance dividers are commonly used when the load added by the divider does not materially affect the phenomenon under investigation and where the voltage under test is not sustained so long as to overheat the divider.

### Power supply

As will be seen in the complete circuit, the 110-volt, 60 cycle power supply feeds three separate valve rectifiers, namely: (a) the 50 kv rectifier supplying the cathode voltage; (b) The 8 kv rectifier supplying the oscillograph relay and timing circuit, and also furnishing the dc calibrating voltage; (c) The 400-volt rectifier, supplying the oscillator and the film drum exposure control.

The 110-volt ac circuit also feeds the Megavac (oil vacuum) pump, the molecular pump, the battery charger and the rotating film drum. A 12-volt battery supplies current to all oscillograph concentration and deflecting coils.

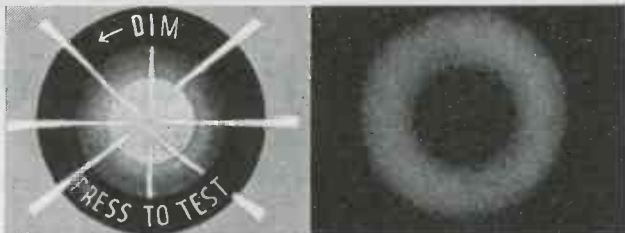

CORRECT LIGHT... DAY or NIGHT...CORRECT LIGHT

## DIALCO "Vari-Dim" PILOT LIGHT #V.M.400

5 DISTINCTIVE FEATURES:—In daytime this unit emits concentrated penetrating light which is visible thru surrounding brightness . . . A turn of the knurled head produces soft diffused light which is ideal for night operation. No effect on operator's vision . . . Field of visibility is a full 150°, 60° more than required minimum . . . Press-to-test — light finger-tip pressure actuates the bulb testing circuit . . . Accommodates screw-base or bayonet base bulbs which can be quickly discharged by finger-tip pressure . . . Assemblies supplied complete with required lamps. Consult us about your problem.

Write for Catalogue



## DIAL LIGHT CO. of America, Inc.

900 BROADWAY • NEW YORK 3, N. Y.

Telephone: ALgonquin 4-5180-1-2-3

BACK THE INVASION—BUY MORE BONDS NOW!

BACK THE INVASION—BUY MORE BONDS NOW!



**When Wire Coils Must Be**

**OVEN-BAKED FASTER**



## **FORMEX\*** *Still Won't Crack*

**because the insulation on Formex magnet wire is highly resistant to heat shock**

One way to speed coil production is to use higher temperatures and faster cycles in the baking process. Ordinary enameled wire can't stand such treatment, but Formex magnet wire can!

The superior toughness of the insulation on Formex enables it to withstand far more abuse in coil manufacture than other wires—in baking, bonding, winding, forming, and handling. This greater toughness affords you an opportunity to reduce rejects while maintaining top-speed production.

Because it needs no fibrous covering, and because it is available in rectangular and square shapes throughout a wide range of sizes, Formex makes possible more compact windings with resultant savings in weight and materials.

As the world's largest user of magnet wire, General Electric makes the same sort of comparisons of installed costs as you might make. These comparisons show that, even

in those few cases where the price of Formex is slightly higher than the price of conventional magnet wire which it replaced, the higher first cost is definitely offset by lower costs of manufacturing the completed coil or installed winding.

Ask your G-E representative to show specifically how you can benefit by using Formex. *General Electric Company, Schenectady 5, N. Y.*

*Round wire sizes: No. 8 Awg to .001 in.*

*Rectangular wire: Full range of sizes*

\*Trade-mark Reg.  
U.S. Pat. Off.

**Buy all the BONDS you can—  
and keep all you buy**

**GENERAL  ELECTRIC**

508-24-1210



## THERMAL STABILITY

(Continued from page 95)

negative-coefficient capacitance as well, to about 0.0025.

The effect of a certain percentage change in inductance is a linear shift, that is proportional to the frequency, as indicated in curve  $\Delta L$  in Fig. 3. Percentage changes in the value of C, however, follow an entirely different variation law, as indicated in the curve  $\Delta C$  in this figure. Also, as will be shown, changes in  $\Delta C_b$  follow a different law, the above cube rule. A combination of all three circuit parameters produces a wide variety of drift relations, as might be seen by looking at the resultant curve  $\Delta f$  obtained by adding together the three individual curves that are shown in Fig. 3.

The curve for  $\Delta C/c = .01$ , Fig. 3, is obtained from the table on page 95. Although all values are assumed, they are of a magnitude that can possibly occur in practice.

In other words, if the tuning capacitor can be assumed to have a fixed thermal coefficient so that  $\Delta C/C$  is a constant, the frequency shift would follow a curve plotted from the data in the last column.

The previous analysis has been concerned with the frequency drift in oscillators caused by thermal variations. In the first place, the setting of the oscillator may not be the only factor that determines the frequency that will be received. Also, tube voltage parameters can cause substantial changes in frequency, but this latter is largely a design factor, involving mainly the location of the tap on the oscillator coil. This problem will not be considered here.

### Drift compensation

If the oscillator frequency is higher than the incoming frequency, its thermal drift is sometimes assumed to be compensated partially by the drift of the if stages. The extent to which this takes place depends upon the relative frequencies of the oscillator and the if. An .001 per cent change in frequency in a 55 megacycle oscillator is equivalent to a .005 per cent change in the if (11 megacycle) stages of the receiver. In the latter case, however, there is a fixed frequency shift at any temperature variation, while in a variable frequency oscillator the drift is rarely constant over the range. Although keeping the oscillator frequency higher than the input frequency will only produce a partial correction, it still should be considered in any design since it is well to have all factors work toward improving conditions rather than making them worse.

It is hoped that this review of some of the common causes of fre-

## HOW *Durant* MACHINES COUNT ACCURATELY and SPEEDILY WITH UNITED CINEPHONE ELECTRONIC CONTROLS

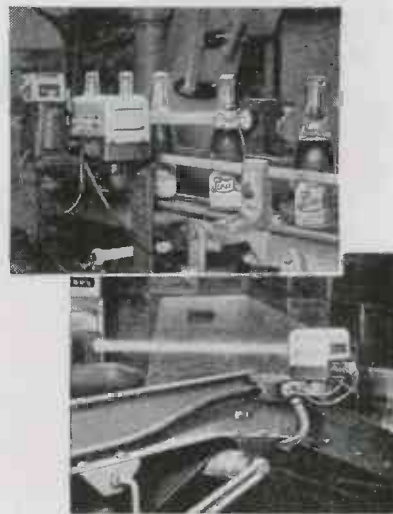

In the field of counting mass-produced articles Electronic devices insure the utmost accuracy, reliability, and economy. In the business of bottling, where profits are a fraction of a penny on each unit, the system devised by the Durant Manufacturing Company maintains a stock count at all times from the initial bottling process through a count of the cases as they leave the factory for shipment. This is only one of the many ways in which United Cinephone Electronic Controls are used in modern production; a necessity in the forthcoming postwar era of highly competitive business.

OTHER APPLICATIONS of United Cinephone Electronic Controls are almost without limit. If you have a problem of measuring, gauging, counting, sorting, heating, or some other operation in your plant, which is costly and unreliable, you will want to investigate the possibility of solving the problem ELECTRONICALLY. That's where our extensive experience and facilities in Electronic design, engineering, and manufacturing can be of invaluable help. Your inquiry will be welcome.

Electronic fields we cover include:

1. Industrial Controls
2. Aircraft Communications
3. Laboratory Test Equipment
4. Radio and Audio Equipment

## UNITED CINEPHONE CORPORATION

28 NEW LITCHFIELD ST.  
TORRINGTON, CONNECTICUT



# STRENGTH

There's satisfaction in buying antennae from Snyder. There's solidity to the organization—there's quality to their products—there's a definite price advantage. Make your next order to Snyder.

ANTENNAE

by

**SNYDER**  
MANUFACTURING CO. • PHILADELPHIA

COMPLETE MANUFACTURERS  
FROM START TO FINISH

quency drift will point out possible corrective methods when a given circuit must be improved. There is nothing that is so bothersome as to have to readjust the tuning of an FM or television receiver after each 5 or 10 minutes operation during the first half hour's operation, to keep the signal tuned in.

From tests at several points in the tuning range, it is usually possible to discover whether improvements should be made in certain components or whether a ceramic compensator with a definite drift rate can be used, or whether a bi-metallic strip is applied to alter the inductance (as by shifting the permeability tuning slug) of either the oscillator coil, or the if transformer coils.

### RADAR SYSTEM

(Continued from page 80)

across the gap will prevent energy from being transferred to the output cavity and consequently damaging the receiver.

Some antenna arrays suitable for radar use are stacked dipoles with an untuned reflector; a radiator with tuned reflectors; and the dipole with parabolic reflector. In the case of the parabolic reflector very narrow rf beams can be produced where the diameter of the reflector is large in comparison to the wavelength. In the microwave region where wave guides are practical, the antenna may take the form of horns, or other impedance matching wave launcher.

### Radar receivers

Since radar frequencies are high it is difficult to obtain sufficient amplification. The superheterodyne principle may be used and components of high stability and sensitivity are required. A block diagram of such a receiver is shown in Fig. 10. In general the power rf signal is fed directly to the mixer tube. The mixer and local oscillator are located close to the T junction of the transmission line in order that the received rf energy may be converted to a lower frequency before being passed on to the remaining elements of the receiver. Such a receiver is typical of UHF practice. The mixer is a non-linear element such as a diode, or mineral crystal. The frequency conversion elements must be located close to the transmission lines to minimize rf losses. Multiple frequency conversion is essential to high gain if amplifiers.

The output of a conventional second detector is fed into a wide band amplifier typical in many respects to the video amplifier in television receivers. The output of this amplifier is connected to the cathode ray indicator system. (Turn page)



**It's FREE! It's NEW!**

# CONCORD BUYING-GUIDE and REVISED LISTINGS Radio Parts

Just published! Concord's great, new 68-page Buying-Guide and latest 1945 Revised Listings of standard lines of Condensers, Transformers, Resistors, Tubes, Test Equipment, Repair and Replacement Parts, Tools, and hundreds of other essential items. Page after page of top-quality radio and electronic parts, and a special 16-page Bargain Section offering hundreds of hard-to-get parts at important savings. Mail the coupon now for your FREE copy. Use it to get what you need—and get it fast—from Concord.

**Quick Shipment from CONCORD  
CHICAGO or ATLANTA**

Concord carries vast stocks. Concord ships to you *at once* from the nearest shipping warehouse, CHICAGO or ATLANTA. Concord invites you to consult our technical experts on special requirements. Concord can expedite any "essential" order and speed action. Concord now serves the United States Government, Institutions, Industry—and can serve YOU, whether you want one part or a hundred. Telephone, wire, or write your needs. And rush this coupon for the new 68-page Buying-Guide. It's FREE.

 <p><b>AUTO-LITE RELAY</b> Solenoid relay similar to relays on autos with push-button starters. 8.5 to 14 volts D.C., with heavy double make contacts. 3 1/2" x 3 3/8" x 2 1/4". A14516. Specially priced, <b>\$1.19</b></p>	 <p><b>MIDGET POWER TRANSFORMER</b> Pri. 117 volts, 60 cycles. Secondary 6.3 volts @ .5 amps., 130 volts @ 150 M. A., 50 volts @ 65 M. A. Size 3 1/4" x 3" x 2 1/2". A5959. Your cost, <b>98c</b></p>
 <p><b>6" PM SPEAKER</b> Ideal for AC-DC radios, P. A., and intercom replacements. 5 B 7 0 0 0. Your cost, <b>\$1.98</b></p>	 <p><b>TAPPED RESISTOR</b> Vitrous resistor, 90 watts, 6.4 ohms resistance tapped in 20 steps of .32 ohms ea. 5B197. Your cost, each, <b>89c</b></p>
 <p><b>HOOK-UP WIRE</b> # 20 solid rubber covered. Red or yellow. 100-ft. coils. Specify color. Your cost, each, <b>49c</b></p>	<p><b>CONCORD RADIO CORP.</b> <i>Lafayette Radio Corporation</i> CHICAGO 7, ILL. 901 W. Jackson Blvd. ATLANTA 3, GA. 265 Peachtree Street</p>
 <p><b>KURMAN RELAY</b> Type 223C34, S.P.D.T. contacts. 2.5 v. D.C., 8 MA, 300 ohm coil. 5B4020. Specially priced, <b>\$2.50</b></p>	 <p><b>AUDIO REACTOR</b> Sealed. .15 Hy at O. D.C. current. Con 2" x 2" x 2 1/4" with 4 1/2" mtg. inserts. 5B5010. Your cost, <b>\$2.95</b></p>

## CONCORD RADIO CORP.

*Lafayette Radio Corporation*

CHICAGO 7, ILL.  
901 W. Jackson Blvd.

ATLANTA 3, GA.  
265 Peachtree Street

**Mail Coupon Today for FREE BOOK!**

Concord Radio Corp.  
901 W. Jackson Blvd., Dept. J-55  
Chicago 7, Illinois  
Please RUSH FREE copy of  
CONCORD'S new 68-page  
Buying-Guide and Revised  
Listings, just off the press.



Name \_\_\_\_\_  
Address \_\_\_\_\_  
City \_\_\_\_\_ State \_\_\_\_\_



# DUMONT CAPACITORS

FOR DEPENDABLE RADIO REPAIRS

SOLD ONLY THROUGH  
EXCLUSIVE JOBBER  
TERRITORIES...

DUMONT ELECTRIC CO.

34 HUBERT ST. NEW YORK, N. Y.



NOTICE: Sales Representatives, Some Territories Open.

**NEED SMALL, INTRICATE  
METAL STAMPINGS  
TO CLOSE TOLERANCES?**



**GOAT Precise-Formed  
METAL STAMPINGS**

**HOW GOAT SAVES YOU  
TIME AND MONEY**

Goat specializes in the design and fabrication to close tolerances of small, intricate, drawn, formed, stamped metal and alloy parts. Expert tool design, quality control, and modern manufacturing techniques can save you time and money on parts like those illustrated above.



**GOAT METAL STAMPINGS, INC.**

AN AFFILIATE OF THE FRED GOAT CO., INC.  
314 DEAN STREET, BROOKLYN 17, N. Y.

ENGINEERS  
SEND US  
YOUR  
PROBLEMS

The presentation of time intervals through the use of a cathode ray tube is fundamental. The sweeping of a cathode ray beam at uniform and accurately known velocity is standard practice, particularly in the case of television.

In radar, the simplest form of indicator is a cathode ray tube, horizontal sweep generator and provision for synchronization of the sweep. The output of the wide band amplifier in the receiver is connected to the vertical deflection system of the CR tube. The initial and echo pulse are then delineated and appear as in Fig. 2. Locally generated precise-timed pulses can be superimposed on the screen for accurate determination of the echo delay interval, (and thus the range).

Another possible indication system to combine range and azimuth or range and elevation could employ the raster pattern of television. For example, the CR spot motion in one direction can be used to indicate range as just described. The spot deflection at right angles can be synchronized with the angular movement of the antenna beam. Any echo pulse from the receiver is then used to modulate the grid of the CR tube and thereby produce a bright spot at the range and azimuth position where the reflecting object is located. An example of this system is shown in Fig. 11. A similar raster coordinate system with target spots controlled by grid impulses has been used for television studies.<sup>3</sup>

A block diagram of the essentials of a radar indicator system is given in Fig. 12. In many respects it is identical to the horizontal synchronization and deflection circuits of a television receiver. The indicator gate is a rectangular pulse applied to the CR tube grid when the forward sweep is made. The spot is biased to cut-off at all other times. Horizontal and vertical blanking signals do a similar job in television.

- 1 The Cathode Ray Oscillograph in Radio Research. Watt, Herd, Bainbridge-Bell. Chapter 3.2. Revista Grafica, Enero, 1944. Observaciones de la Ionosfera en la Plata—Malvarez—p. 19.
- 2 Einrichtung zur Bestimmung des Abstandes reflektierender Flächen, insbesondere zur Bestimmung der Flughöhe von Luftfahrzeugen. DRP 726461. Filed Sept. 24, 1938, issued Oct. 14, 1942 (Siemens & Halske.) Patzold & Ernst.
- 3 A Method and Equipment for Checking Television Scanning Linearity. V. J. Duke—RCA Review, Oct. 1941, p. 190.

## MEETING SPECS

(Continued from page 85)

made lower, so much the better, and often by the intelligent analysis of control charts and by on the job observation it is possible to eliminate an inspection position or combine it with another, making both part time. The test for this is obvious: if no defects are found there

ALL THIS, AND

# electronic switching, TOO!

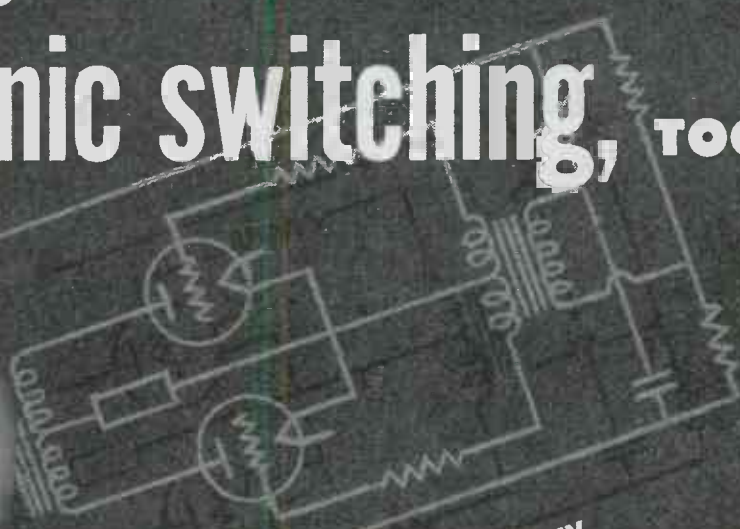
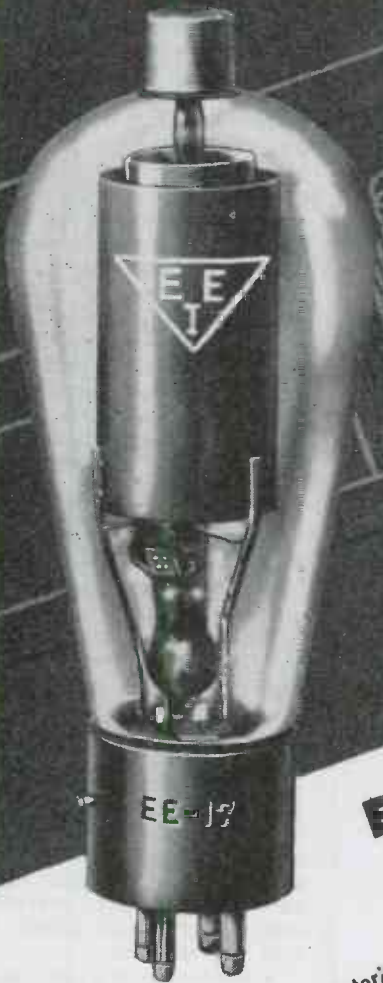

- HEAVY PLATE CURRENT CAPACITY
- CONTINUOUSLY VARIABLE OUTPUT
- HIGH INVERSE VOLTAGE RATING

## E-E Type 17 Rectifier

*... for greater efficiency!*

The electrical characteristics of the E-E 17 grid controlled rectifier have resulted in its wide adaptability in industrial applications. At condensed mercury temperature of 20 to 60° C, peak plate current is 2.0 amp.; peak inverse voltage 7,500. Heating Time is 30 seconds, deionization 1,000 micro-seconds and ionization time 10 micro-seconds.

Desirable as the above characteristics are, the full measure of E-E17 efficiency must include consideration of application scope by virtue of efficient grid control. This feature permits continuously variable output—an extremely important factor in industrial application. It also makes possible effective on and off control of output—for example in transmission keying, induction heating control, etc. For exact fulfillment of requirements, other E-E grid controlled rectifiers provide a full range of characteristics, completely covered in the comprehensive E-E Data Book. Write for it today.

### ELECTRONIC ENTERPRISES, INC.



GENERAL OFFICES: 65-67 SEVENTH AVENUE, NEWARK, 4, N. J. EXPORT DEPT. 25 WARREN STREET, NEW YORK CITY, N. Y., CABLE ADDRESS: SIMONTRICE, N. Y.

# SUPER-WETTING KWIKFLUX SPEEDS PRODUCTION



*Fast Flowing . . . No Lumping  
Or Pitting of Solder*

KWIKFLUX accomplishes 25% to 50% higher wetting action than the fluxes now on the market, and has almost 100% higher penetration in deep joints. It works perfectly with direct gas flame, hydrogen, acetylene—muffle (direct and indirect) and induction heating.

KWIKFLUX is used for brazing, hard soldering and welding of Stainless Steel, Iron, Copper, Brass, Bronze, Platinum, Gold, Silver, Monel Metal, Nickel, German Silver and other ferrous or non-ferrous metals and alloys. It will not blacken brass or copper, and is suited to either automatic or manual operations. Fast, efficient action assures improved quality and finish.

MEETS GOVERNMENT AND ALL RIGID  
STANDARDS AND SPECIFICATIONS

For more than 12 years, our tested research improvements have been passed on to our customers. This service has been in operation during the war period.

WRITE FOR LITERATURE

Data sheets describing KWIKFLUX in detail—advantages, properties, characteristics and price—will be sent promptly on request. There is no obligation.

SPEC

## KWIKFLUX SPECIAL CHEMICALS CO.

32-34 IRVING PLACE NEW YORK 3, N. Y.

OUR NEW PRICE  
SCHEDULE EFFEC-  
TIVE JAN. 1ST, 1945  
PLACES KWIKFLUX  
ON AN ALL-INCLU-  
SIVE COMPETITIVE  
BASIS.

### Features:

- (1) Perfect with both Low and High Melting Point Hard Solders.
- (2) Excess Flux washes off clear in hot water—serves cleaning and finishing time.
- (3) Does not lump or pit solder. Forms smooth film easily washed off, leaving surface beneath bright and shiny.
- (4) Faster Fluxing Actions—saves time, gas and electricity.
- (5) Fumes are fixed because KWIKFLUX is neutral. Increases production efficiency.

SEND FOR FREE  
TRIAL JAR

is no use inspecting! It is in this type of analysis and in tracing back the cause of defects that a good visual inspection foreman proves himself.

When the equipment has passed the mechanical inspection group successfully, it goes to the electrical inspection or testing section. Like the visual inspection group, the testing section should be organized with job leaders reporting to a foreman. Personnel, however, would be entirely different as it is usual to employ ex-amateurs or men with radio servicing experience for testing work.

It cannot be emphasized too strongly that enough testing equipment should be provided to do more than the maximum required by the production schedule and to provide it in the form of well conceived, ruggedly built and efficient equipment. Such equipment will have to stand a lot of concentrated daily usage for months on end, and much time of testers—nowadays hard to obtain—production delays and irritation will be avoided by such thorough planning and construction that all important difficulties will have been foreseen and ironed out in advance.

No cost figures can be given for electrical testing as often the testing involves calibrations and charts which add direct value to the product. The number and nature of tests usually will be arrived at in conjunction with the Inspection Services. In setting up a production line, this problem should be thoroughly considered in advance and adequate provision of space and handling facilities made to prevent confusion. Here the old rule of "a place for everything and everything in its place" definitely will pay dividends.

A minimum of paper work should be required of the quality control organization, but certain items are necessary, and others are definitely advisable. Certainly chassis passing through a series of production, inspection and test operations should have tags attached to them to indicate inspections, tests and repairs performed on the set. Furthermore control, not only of the production but of the performance of individual operators requires that at important inspection and test positions a sheet should be kept showing throughput and the number and nature of defects encountered.

In consolidating this information, it usually is not necessary to know how many times any given set has been tested and repaired. Each set presented for test can be considered the same as a fresh set. In this way the quantity of sets put through any test position will be greater than the finished product shipments by the number of retests. The total quantity tested of course shows the load on the test position.

## Wanted ENGINEERS

Radio  
\*Electrical  
Electronic  
\*Mechanical  
\*Factory Planning  
Materials Handling  
Manufacturing Planning

Work in connection with the manufacture of a wide variety of new and advanced types of communications equipment and special electronic products.

Apply (or write), giving full qualifications, to:

R.L.D., EMPLOYMENT DEPT.

### Western Electric Co.

100 CENTRAL AV., KEARNY, N. J.

\*Also: C.A.L.  
Locust St., Haverhill, Mass.

Applicants must comply with WMC regulations

RADEX

# RADEX

CHICAGO

In future peace-time production, Radex will uphold its war-won reputation by the scope and caliber of its service to the radio and electrical industries.

### Radex Corporation

53 W. Jackson Blvd., Chicago 4, Ill.

Mention was made of the need for supplying the test positions with enough good equipment and personnel to more than carry the production schedule. If a complicated set must be put through five test positions and seven per cent are defectives at each position, about 144 sets will have to be tested in the first position to get 100 into the shipping room. If in addition the production line is held up part of the month due to material shortages, even the imposition of a strenuous overtime schedule may not suffice to permit delivery on time. If, however, a little margin of equipment is available the problem will readily be solved.

### Test equipment section

The use of control charts such as are described in American Standards Association bulletins ASA Z11.1, .2 and .3 for charting the percentage defectives or the number of defects per unit is strongly recommended. No elaborate set up need be made for this, and an hour or two a day of a computation minded clerk's time is all that is needed if the managing engineer of the department familiarizes himself with the subject so he can give the work the necessary supervision. Even though these charts have not been used much heretofore on "small" production, they have been found to be applicable and to give immediate notice to the production manager when something is going wrong.

In order to have the adequate supply of good test jigs and equipment needed for sound production line testing, thorough and intelligent preparation for months in advance is required. To this work must be devoted the time of one or more competent engineers and helpers in a test equipment section. The responsibility of this section is to analyze coming test requirements, anticipate needs for test jigs, design and construct them. It must also set up the tests in advance, try them out carefully and eliminate faults and check on the time needed for the test. It must also write a detailed and accurate test procedure. This should be clear and complete in itself so that if the job has to be rerun a year later with different personnel, trouble in setting up and operating the tests will be at a minimum. This test equipment section additionally has charge of the storage and maintenance as well as routine checking of metering equipment.

In view of the exacting nature of this section's work, it should definitely be staffed with the most competent persons available having the temperament of doubting Thomases. If the specifications for a piece of UHF test equipment, for example require a calibrated output of 10 db below 1 milliwatt to



**AMCON**

**AN AMERICAN SOLUTION TO YOUR CAPACITOR PROBLEMS**

**ALL TYPES · BY-PASS AND ELECTROLYTIC**

**DATA SHEETS ON REQUEST**

**AMERICAN CONDENSER CO.**

**4410 No. Ravenswood Ave. Chicago 40, Ill.**

**HEXA CON** *is helping to do the job at* **Westinghouse**



**TYPE P-200 for quick, ample heat and long life...**

One of the major suppliers to the Armed Forces in wartime, and to civilian requirements in peacetime, Westinghouse has consistently specified HEXA CON soldering irons for continuous production needs.

**"BALANCED HEAT"**

Incorporating the exclusive new HEXA CON principle of design, excessive element-impairing heat is dissipated by the patented hexagon-shaped barrel. Over-heating is minimized, efficiency and economy are increased.

**HEXA CON ELECTRIC CO.**  
157 WEST CLAY AVE., ROSELLE PARK, N. J.

**WRITE FOR LITERATURE**  
The HEXA CON is one of the most complete available today; included are a diversity of types and sizes. All are described in fully illustrated literature; write today, no obligation.

**HEXA CON**

**HIGH-QUALITY LONG-LASTING SOLDERING IRONS**

**SERVICE**  
THROUGH THE  
**YEARS!**

1945



America's  
MOST COMPLETE  
Source of Supply

for

RADIO PARTS

RADIO TUBES

INDUSTRIAL

ELECTRONIC EQUIPMENT

AMPLIFIERS

SOUND SYSTEMS

TEST INSTRUMENTS

COMMUNICATIONS and  
BROADCAST APPARATUS

AIRCRAFT and

MARINE EQUIPMENT

F/M—television—A/M



OVER 10,000 ITEMS!  
AT YOUR FINGERTIPS!

PURCHASING AGENTS!  
ENGINEERS!

Send for this  
FREE 800 PAGE CATALOG!

Write today on your company letterhead for this massive 800 page Buying Guide containing everything in radio-electronics. Complete listings of all standard nationally known products in one handy, bound volume! Sent free on request by addressing Box FE.



This Book  
Can Help Answer  
Your Procurement  
Problems!



FOR PROMPT SERVICE  
Telephone BARclay 7-1840

BUY THAT EXTRA BOND NOW  
and SAVE AN EXTRA LIFE!

SUPPLIERS TO

Industrial Manufacturers • Research  
Laboratories • Schools • Colleges  
Government Agencies • Railroads  
Public Utilities • Broadcast Stations  
Hospitals • Shipyards • Police Depts., etc.

**SUN RADIO**  
& ELECTRONICS CO.

212 Fulton Street, New York 7, N. Y.

be produced to an accuracy of  $\pm 2$  db, the test equipment design engineer must have no doubts in his mind about the chain of steps which has been taken to guarantee that figure. It is desirable that all measurements be susceptible of being referred back to some primary standard such as WWV signals and standard inductances, capacities, resistances or standard cells. In addition, a definite program of routine calibration of measuring equipment should be adopted and adhered to rigorously.

#### Helpfulness a need

An organization such as has been described will build confidence in itself not only in the minds of the company's customers, but also within the company itself, and will prove to have definite monetary value, as well as being a business getter.

A word should be added about the policy of such a quality control department. Due to the nature of its work, it is constantly in a position to uncover mistakes made by others in the company. In regard to these it must adopt a selfless attitude of trying to be helpful rather than critical. The curse of any manufacturing organization is glory hunting, and of course such a practice is apt to be prevalent where the top management, itself inexperienced in manufacturing, tends to listen to the best salesman to its eventual sorrow.

#### GUN SOUND RANGING

(Continued from page 89)

The modulator generates a 2,500 cps audio tone, which is modulated by the lower frequencies of the gun muzzle blast picked up by the microphones. This modulated audio tone is then transmitted from the microphones through regular radio sets to a receiver at the central station. There it is demodulated by filtering out the audio tone, leaving the low frequency signal to be recorded.

Also reported recently has been the further refinement of regulation sound ranging equipment. These changes have resulted in lighter, more portable, equipment and greater ease of operation. Lightness and portability have been effected by decreasing the number of components and by a corresponding decrease in the size and weight of elements of the equipment. The recording unit of the new equipment weighs 85 lbs. as against the 450 lbs. of the same units in the older equipment. The number of microphones needed has been reduced from a maximum of eight to a maximum of six and each microphone has been reduced in weight from 25 to 10 lbs. Through the use of styli and electrosensitive paper, photographic material here-

THERE'S A **DRAKE**  
**SOLDERING IRON**  
FOR EVERY TYPE OF  
ELECTRONIC WORK

From that mighty mite



the Drake No. 400 to the high-speed production "honey"



the Drake No. 600-10 there is a high quality Drake Soldering Iron "just right" for the job.

Drake Heat Controls and the Drake "Magic Cup" Stand are important soldering aids.



SEE  
YOUR RADIO  
PARTS JOBBER

**DRAKE ELECTRIC WORKS, INC.**  
3656 LINCOLN AVE. CHICAGO, ILL.

Complete • Authoritative  
Up-to-the-minute

**AVIATION  
RADIO**

by Henry W. Roberts

Introduction by  
Dr. Lee de Forest

For everyone concerned with flying—here in one volume is everything you need to know to understand and use aviation radio.

Fully detailed and lavishly illustrated. Over 465 illus. 652 pages.

\$5.00

WM. MORROW & CO., Publishers  
425 4th Ave., New York 16



# 9 Years of Continuous Service!

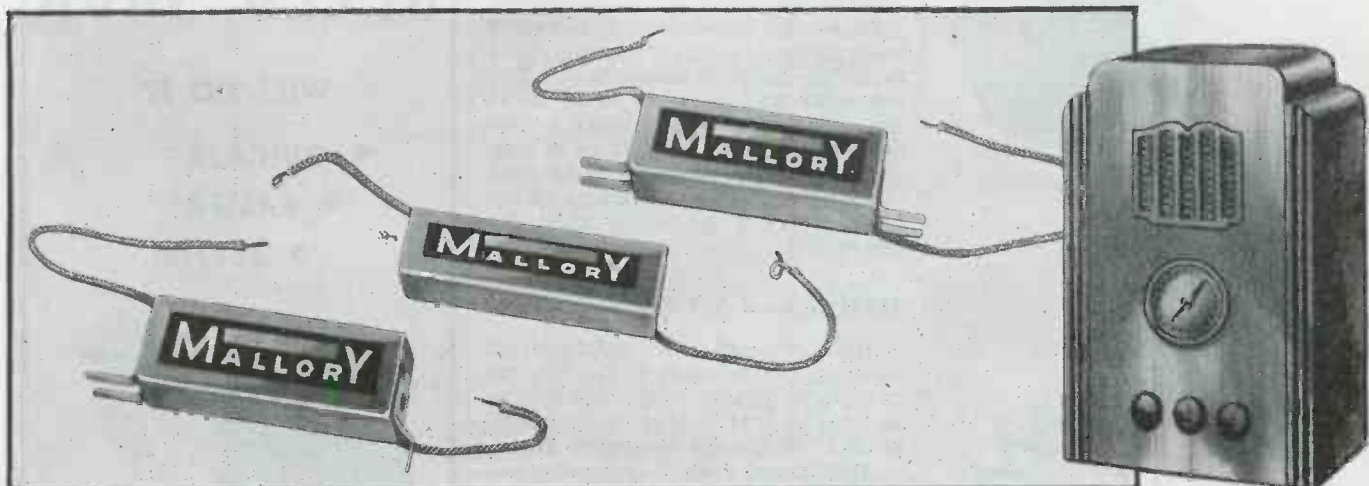

These three Mallory Capacitors are in excellent condition after nine years of service in a radio receiver.

## With these MALLORY Capacitors

RECENTLY the owner of an early model radio believed it advisable to replace the three Mallory Capacitors which were installed over nine years ago. Tests showed that these condensers were in excellent condition—ready for further use after nine years of service!

This case history is no guarantee, of course, that every Mallory Capacitor will last a decade. It does show how dependability and long life are built into condensers by Mallory precision workmanship.

Under wartime conditions, in military applications where severe vibration and extremes of humidity and temperature are common, dry electrolytic capacitors made by Mallory have undergone the most rigorous tests imaginable. Results in the field have proved Mallory quality repeatedly—and have suggested improvements both in materials and designs.

Mallory has long pioneered in developing capacitors with increased operating temperature ranges . . . remarkable reductions in size for rated capacity . . . and greater efficiency over a longer life. Today Mallory research is pointing toward even better capacitors, while Mallory continues to build the best available.

See your nearest Mallory Distributor or write today for your free copy of the latest Mallory catalog, for more data on dry electrolytic capacitors.



P. R. MALLORY & CO., Inc., INDIANAPOLIS 6, INDIANA

A large advertisement for Mallory capacitors. On the left, there are two rectangular capacitors and two cylindrical ones. In the center, the text reads 'P. R. MALLORY &amp; CO. Inc. MALLORY Electrolytic, Film and Paper CAPACITORS'. On the right, there are three cylindrical capacitors, one of which is labeled 'MALLORY A.C. MOTOR STARTING CAPACITOR'.



**High-Voltage  
CONTROLS**

★ The ingenious Clarostat Series 60 Hi-Voltage Coupler provides either 3,000 or 10,000 volts breakdown insulation between the control proper and its shaft and mounting.

This coupler is available with Clarostat Midget Controls Series 37 (composition-element) and Series 43 (wire-wound). Also with the large Series 58 wire-wound controls. Likewise with Clarostat series 42 multiple tandem controls.

Especially desirable for controls used in high-voltage circuits such as television equipment, cathode-ray oscillographs, and many electronic applications. Neat. Unit mounts as readily as usual control. And SAFE where high voltages are involved.



★ Write for DATA...



CLAROSTAT MFG. CO., Inc. • 285-7 N. 6th St., Brooklyn, N. Y.

tofore necessary for recording has been eliminated. About 250 lbs. of such photographic material had been needed previously for 3 months' operation of the equipment.

Improved effectiveness has also been secured through the increased range of the new microphone. The old mike had a range of 15 to 25 cps. The new mike covers a frequency range of from 15 to 60 cps, enabling the equipment to be used for ranging on mortar blasts which have a higher frequency than artillery guns.

### Hollywood SMPE Meet

The fifty-seventh semi-annual technical conference of the Society of Motion Picture Engineers was to be held May 14 to May 18, inclusive, at the Hollywood-Roosevelt Hotel, in Hollywood, Calif. Dramatic advances in wartime military and naval use of motion pictures and in theatre television, motion picture sound recording and reproduction, and motion picture photography and projection were to be presented at nine technical sessions during the five-day conference. The use of film in television programming and the relationship of television and motion picture practices were among topics of scheduled papers.

The chairman of the Pacific Coast Section of the SMPE is H. W. Moyses. Committee chairmen for the convention include the following: Papers—C. R. Daily, chairmen (West Coast), and Barton Kreuger, vice chairman (East Coast); Publicity—E. O. Blackburn (West Coast) and Julius Haber (East Coast); Registration and Information—William C. Kunzmann; Reception and Local Arrangements—Emery Huse; Luncheon and Dinner-Dance—L. L. Ryder; Hotel and Transportation—C. W. Handley; Projection Programs—R. H. McCullough (35-mm) and H. W. Remerscheid (16-mm).

### Measuring Projectile Speed

The latest methods of measuring projectile speeds include direct measurements from enlarged photographs, and measurement of speeds by photo-electric effects, reported Dr. Thomas H. Johnson, Chief Physicist of the Ballistic Research Laboratory, Aberdeen Proving Ground, in a lecture delivered under the auspices of the New York Electrical Society.

In the photo-electric method, projectiles shooting past a photo-electric screen change the intensity of the light falling on it, inducing momentary changes in current. The pulse produced, lasting for a fraction of a second, registers an image on an oscilloscope. The width of this image is measured on a scale calibrated in millisecond intervals. Accuracies to 1/100,000 second are obtainable.

# SPEED IRON

WILL DO IT

- QUICKER
- EASIER
- BETTER

Model B

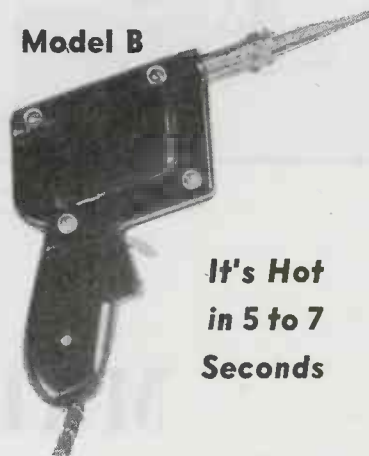

**It's Hot  
in 5 to 7  
Seconds**

**The Only Soldering Iron  
That's Always Ready**

Speed Irons contain a Hi-current, Lo-voltage transformer with its primary controlled by a normally off switch. To the secondary is connected the soldering tip, a length of No. 11 copper. This flexible tip will do readily, jobs formerly difficult or impossible.

# SPEED IRON

100 Watts 115 V. 60 Cycles

PRODUCT OF  
**WELLER MFG. CO.**  
EASTON, PA.

Distributors' Inquiries welcomed. . . . Write Dept. I.

# PLASTIC PARTS

... PRODUCED TO YOUR SPECIFICATIONS

## PRINTING DIE CUTTING CEMENTING

Wide experience by all known processes in the application of printing, engraving, silk screening, die cutting and cementing of all thermoplastics.

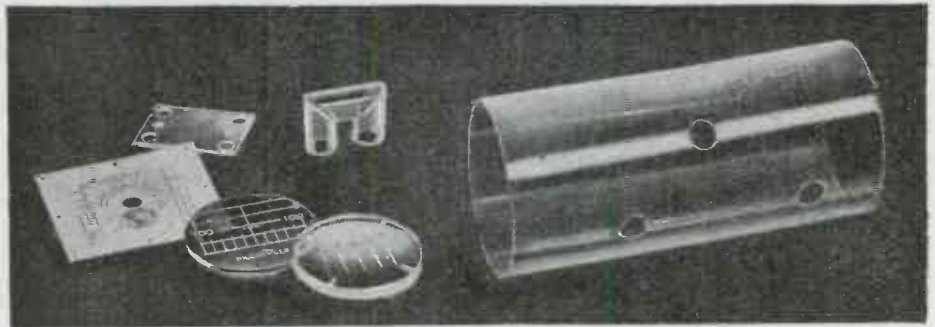

## FORMING

Specialists in deep drawing radio dial windows, embossing, swaging and bending in Acetate, Vinylite and Acrylics.



## MACHINING

Precision threading, screw machine, milling, drilling, turning of Polystyrene, Acrylics, Phenolics, Nylon, Tenite; sheets, tubes and rods; through spindle capacity up to 2½" rod.

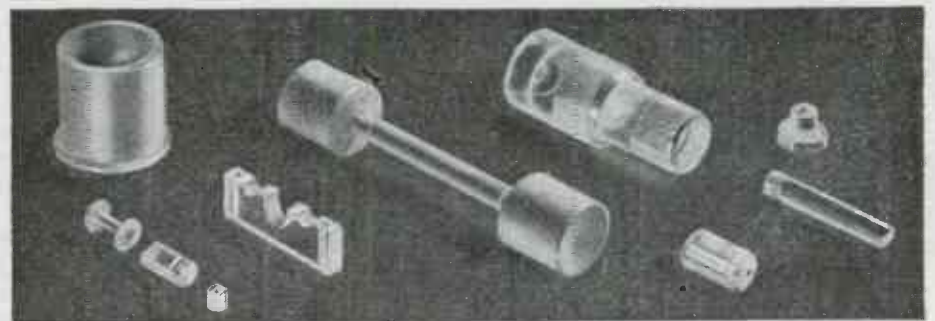

## ASSEMBLY

Our engineers can assist you in problems of design and assembly of your plastic units.



# PRINTLOID, Inc.

93 Mercer Street  
New York 12, N. Y.

*Elinco*  
A.C.  
**DRAG-CUP**  
INDUCTION  
GENERATORS



**BOTH BASE AND FRAME MOUNTED MODELS**

New "Elinco" Drag-Cup Induction Generators are of die-cast aluminum alloy housing anodized in accordance with Army and Navy specifications, and furnished with baked black synthetic enamel.

**OPERATION:**

Generators consist of laminated stator wound two phase, stationary steel pole, and aluminum cup on shaft rotating between stator and pole. With voltage applied to one of two stator phase terminals, rotation of shaft and cup induces voltage at other terminal, voltage lineal with speed. Torque required for rotation approx. 25 grains at 1" radius. For increased voltage where linearity is not important, copper cup may be used.

**SPECIFICATIONS:**

Type 68: Applied voltage 115 v. 60 c. AC, generated voltage with resistive load 100,000 ohms varies from 0.15 v. max. with cup stationary, to 1.20 v. min. at 1,000 RPM, and to increase at uniform rate up to 6,000 RPM.

Type 101: Generates from 0.15 v. max. with cup stationary to 3.65 v. min. at 980 RPM, and 20.0 v. at 5,600 RPM.

MODELS CAN BE VARIED TO MEET SPECIAL REQUIREMENTS

*Electric Indicator Co.* 112 PARKER AVE.  
STAMFORD, CONNECTICUT

**NEW BOOKS**

**Electric Power  
Distribution for  
Industrial Plants**

Published by the American Institute of Electrical Engineers, 33 West 39th St., New York City, \$1.00.

This report is intended to promote good engineering principles in the design of electric power distribution systems for industrial plants and in the selection of equipment for those systems. It is not an A.I.E.E. standard and the recommendations are not mandatory or restrictive.

Report covers basic wiring systems, equipment selection, low voltage distribution principles, including safety, fault current calculations and information on wires and cables.

**The Effective  
Reproduction of Speech**

Published by Jensen Radio Mfg. Co., 6601 South Laramie Ave., Chicago 38, Ill., 25c.

No. 4 in the series of technical monographs published by Jensen, the Effective Reproduction of Speech covers the important factors necessary for intelligibility, particularly at high intensity levels. A number of curves on peak pressures in speech over a frequency band and total power spectrum are given along with data on amplifier ratings, and practical considerations. A bibliography is included at the end.

**Tables for Converting  
Rectangular to Polar  
Co-ordinates**

By J. C. P. Miller, Ph.D., published by Dover Publications, New York, N. Y., 75c, 1944.

A 16-page booklet for computing the radius vector and angle from given polar co-ordinates. The tables are based on the argument  $k$  which is the ratio of the smaller to the larger of the two rectangular co-ordinates. A system of quadrant signs and relative magnitudes of the two co-ordinates permits evaluation of the angle. The method is applicable to calculating machines, the slide rule as well as longhand operation.

**Electronics for Radio  
Men and Electricians**

Published by Coyne Electrical School, Chicago, Ill., \$4.95, 1944.

A practical book on electronics prepared by the instruction staff of the Coyne Electrical School, this volume is divided into 20 chapters, beginning with the foundations of electronics, rectifiers, gas-filled tubes and their applications, vacuum tubes as amplifiers, timing,



*Leads the way*

**SUPERIORITY IN  
SOLDERING IRONS**

ICA Irons embody these important construction features:—

Heating elements wound on high heat-resisting bobbin of machined and threaded Insulex. Winding utilizes special resistance wire. Complete bobbin is impregnated in non-hygroscopic ceramic compound. ICA Irons heat up to operating temperature in three minutes, and in one additional minute surpass the heat peak of ordinary irons. Special air chamber reduces heat losses. Thoroughly insulated. Rubber tube protects cord from excessive wearing and short-circuiting. . . .

Write for full details now.

Write for 48-page Catalogue describing the extensive line of ICA Radio-Electronic Products . . . Also 8-page brochure presenting the ICA Manufacturing facilities.

HEADQUARTERS FOR  
RADIO-ELECTRONIC PRODUCTS

**INSULINE**  
CORPORATION OF AMERICA  
INSULINE BUILDING · LONG ISLAND CITY, N.Y.



CK-1089

CK-1090

# RAYTHEON COLD CATHODE VISUAL GLOW THYRATRONS



● Outstanding recent developments by Raytheon's research laboratories are two visual-glow cold cathode thyratrons, types CK-1089 and CK-1090.

The former is a tetrode incorporating two starter electrodes and so can be operated from a balanced line, whereas the latter is a triode with a single starter electrode for grounded line or unbalanced operation. In addition to normal grid controlled thyatron performance, these neon-filled tubes are engineered to produce a good visual glow near the top of the bulb.

This characteristic, and their small size, make them admirably adaptable to telephone switchboard applications where they can be wired directly as a combined relay and indicator lamp. It is also possible to actuate a separate relay in the anode circuit by the initiation of plate current, which, of course, is coincident with the glow. The resulting simplicity and the reduction in weight and size are highly desirable. Thousands of Raytheon CK-1089 and CK-1090 tubes are now giving dependable service in just such an application—even under the worst climatic conditions. Convincing proof, indeed, that Raytheon builds fine tubes... tubes that you should consider for your postwar products!

### TYPICAL CIRCUITS

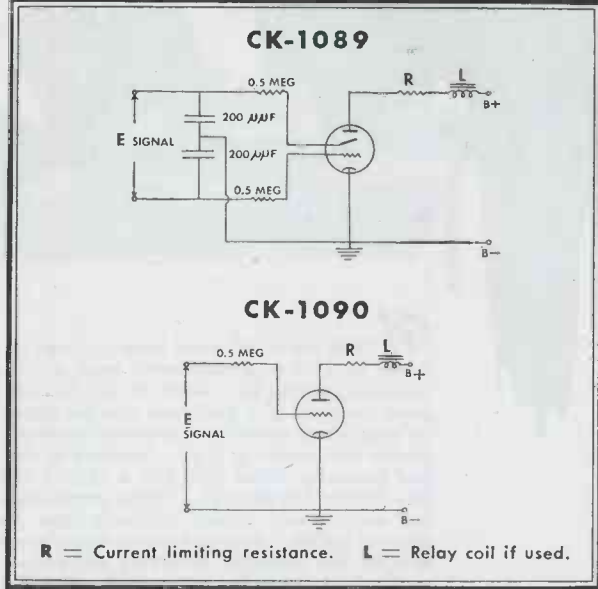

SPECIFICATIONS OF CK-1089 AND CK-1090	
Minimum Peak Anode Breakdown Voltage (No Signal)	225 volts
Peak Positive Starter-Anode Breakdown Voltage	75 min. volts 170 max. volts
Across Starter Electrodes on CK-1089	
Starter Electrode to Cathode on CK-1090	
Approximate Starter Electrode Voltage Drop	90 volts
Maximum Peak Cathode Current	20 ma
Maximum Average Cathode Current	15 ma

# RAYTHEON

RADIO RECEIVING TUBE DIVISION  
Newton, Mass. • Los Angeles • New York • Chicago • Atlanta

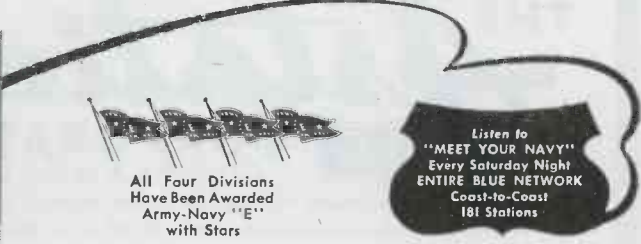

All Four Divisions  
Have Been Awarded  
Army-Navy "E"  
with Stars

Listen to  
"MEET YOUR NAVY"  
Every Saturday Night  
ENTIRE BLUE NETWORK  
Coast-to-Coast  
181 Stations

DEVOTED TO RESEARCH AND THE MANUFACTURE OF TUBES FOR THE NEW ERA OF ELECTRONICS

The Wonder of it All



NEVER has man's mind been so taxed as it is today ... and never have his accomplishments been greater. In supplying the demands created by a world at war, products that were scarcely even dreamed of a few years ago are today realities ... and it all happens so smoothly, so precisely, so naturally, that we scarcely realize the wonder of it all. Research in every field of endeavor has moved us ahead fully half a century in time. So it is with The Astatic Corporation. While producing important essentials for wartime use, Astatic engineers have also planned for the postwar period. Among Astatic's many new and improved products for the detection, recording and pickup of sound will be a zephyr-light pickup for phonograph and radio phonograph sets as important to improved phonograph performance as FM will be to radio. Now, as never before, the human voice and instrumental artistry of the entertainment world will be reproduced from modern recordings with tone fidelity and true-to-life realism to bring a great, new listening audience "closer to the stars."

"You'll HEAR MORE from Astatic"



THE **Astatic** CORPORATION  
 CONNEAUT, OHIO

IN CANADA: CANADIAN ASTATIC LTD., TORONTO, ONTARIO

ASTATIC Crystal Products manufactured under Brush Development Co. patents.

## NEW BOOKS

(Continued from page 234)

welding controls, use of high frequencies, photo tubes and circuits, cathode ray oscillograph, and a chapter on maintenance and trouble shooting of electronic equipment.

The book is very well illustrated with a variety of photographs of actual equipment in conjunction with circuits and charts illustrating text material.

The book is intended for home study and field reference for the electrician and radio man.

### Radio Fundamental Principles and Practices

By F. E. Almstead, K. E. Davis and G. K. Stone, published by McGraw-Hill Publishing Co., New York, N. Y., \$1.80, 1944.

This 220-page book is basic in nature. It includes chapters on electronic theory, direct current, alternating current, vacuum tubes, meters, characteristics of resonant circuits, power supplies, receivers, oscillators and transmitters. Wave propagation, antennas and transmission lines are included in the book.

A large number of illustrations including circuits and photographs, round out the text.

The Symbol



of Time Tested QUALITY!

- Every Illinois Condenser bears the label of "TIME TESTED QUALITY" . . . manufacturing the best in capacitors is our business . . . satisfying you is our desire . . . look for the "Illinois" symbol of excellence when selecting paper and electrolytic capacitors.

ILLINOIS CONDENSER COMPANY

1160 NORTH HOWE STREET  
 CHICAGO 10, ILLINOIS

# COLE

STEEL EQUIPMENT COMPANY

Experience and "know-how" are why so many of America's leading manufacturers depend upon "Cole Steel Equipment" for

*sheet metal fabrication*

We welcome tough assignments . . . instrument housings . . . water-test boxes . . . chassis; some made to extreme precision, others to gauge limits. Send us your blueprints!

Send for our Brochure  
*"The Plant Behind Your Plant"*

349 Broadway, New York 13, N. Y.

Factory: Brooklyn, N. Y.



**COLE STEEL  
OFFICE EQUIPMENT**

will again be available  
after the war

# Another Conant first!

A New Rectifier Assembly  
that Eliminates  
Temperature Variations

Here's important news for users of rectifier type instruments. Conant has done it again! This new instrument rectifier application makes possible for the first time complete freedom from temperature errors. AC values are read on the same linear scale as DC values.

You'll be amazed at the vastly improved frequency response achieved by this new development. This remarkable assembly can be furnished in any of three Conant series (500, 160 or 160-C).

Available to original purchasers of Conant Instrument Rectifiers license free. Write today for details.



**CONANT**

*Instrument Rectifiers*

**ELECTRICAL LABORATORIES**

6500 O STREET, LINCOLN 5, NEBRASKA, U. S. A.

20 Vesey St., New York 7, New York  
85 E. Gay St., Columbus, Ohio  
600 S. Michigan Ave., Chicago 5, Ill.  
1215 Harmon Pl., Minneapolis 3, Minn.

2017 Grand Ave., Kansas City 8, Mo.  
1212 Camp St., Dallas 2, Texas  
378 Boulevard N. E., Atlanta, Ga.  
4018 Greer Ave., St. Louis, Mo.

1526 Ivy St., Denver, Colo.  
4214 Country Club Dr., Long Beach 7, Cal.  
Export Div., 89 Broad St., N. Y. 4, N. Y.  
50 Yarmouth Rd., Toronto, Canada

## NEW BULLETINS

### Paper Capacitors

A new 56-page, profusely illustrated paper dielectric catalog just issued by the Sprague Electric Co., North Adams, Mass., has been designed to serve as a guide to the selection of components for industrial uses. Included are details and dimensions for Sprague cardboard and metal tubular types, bathtub types, large and small rectangular units, cylindrical container units, hermetically sealed types, ignition capacitors, screw-mounted types, radio interference suppression filters, donut-shaped capacitors, 3-terminal network types, fluorescent lamp capacitors, paper dielectric capacitors for ac applications, etc. Also included are details on Sprague energy storage capacitors for welding, flash-photography, and similar uses; Sprague Vitamin Q capacitors for high temperature uses, including the hermetically sealed units in glass tubes; and the Sprague glass-to-metal seals for many types of capacitors and Sprague Koolohm resistors.

### Electrical Tapes

A new 24-page catalog published by the Minnesota Mining and Mfg. Co., St. Paul, Minn., has a center spread, is made up in the form of a chart which gives a complete resume of the relative properties of 18 different types of Scotch electrical tapes. In addition to listing the type of backing, tensile strength, thickness and characteristics such as stretch, adhesion, insulation, dielectric strength, electrolytic corrosion-factor, chemical stability, electrolyte content and melting point, the chart includes samples of each tape which can be lifted off for closer examination. Below the chart, additional supplementary data on each of the 18 tapes is listed for the convenience of tape users. The book is profusely illustrated. It contains about 50 actual photographs of tape applications with a description of the operation shown in each photo.

### Mica Trimmers

In a 12-page catalog the case for the use of standard parts in post-war radios and similar electronic equipment requiring mica compression trimmers is set forth. In it are listed and clearly illustrated all the standard type trimmers. Complete specifications are given for each type including capacity curves and outline drawings showing every essential dimension. Automatic Manufacturing Corporation, 900 Passaic avenue, East Newark, N. J., is the publisher.



# SALT WATER MIKES



Marine microphone assembly. Plastic and metal parts designed, made and assembled by Remler to meet Navy and Merchant Marine specifications.



## PLUGS & CONNECTORS

Signal Corps - Navy Specifications

Types :		PL			NAF	
50-A	61	74	114	150		
54	62	76	119	159		
55	63	77	120	160		1136-1
56	64	104	124	291-A		
58	65	108	125	354		No.
59	67	109	127			212938-1
60	68	112	149			

PLP		PLQ		PLS	
56	65	56	65	56	64
59	67	59	67	59	65
60	74	60	74	60	74
61	76	61	76	61	76
62	77	62	77	62	77
63	104	63	104	63	104
64		64			

OTHER DESIGNS TO ORDER

**ONE REMLER ASSIGNMENT** is the production of amplifying and transmitting systems for our Navy and Merchant Marine. Systems are complete—from shock-proof microphones, built to resist the corrosive action of salt air and water to transmitters and bull-horn speakers for baby Flat Tops. • Remler was organized in 1918 to manufacture ship wireless. Present activities in marine communications are a logical development of early activities in this field. The facilities and experience of this organization are at your disposal.

Further assignments in radio and electronics invited. Consult—

REMLER COMPANY, LTD. • 2101 Bryant St. • San Francisco, 10, Calif.

# REMLER

SINCE 1918

*Announcing & Communication Equipment*

# RADIART VIBRATORS

*The Choice of Discriminating Servicemen!*

**Highest Accuracy, Dependability and Performance.**

The Radiart Reputation was founded on performance—is being maintained by outstanding service on military electronic apparatus—will guarantee full satisfaction on all Radiart Post-War Products. . . . Contact Radiart Distributors for full information and a copy of the Radiart Vibrator Catalog—the most complete Vibrator Catalog published.



## Radiart Corporation

3571 W. 62nd. St.

CLEVELAND 2, OHIO

## NORTON

### Electrical Instruments



**SWITCHBOARD  
& PORTABLE**



**AMMETERS  
VOLTMETERS**

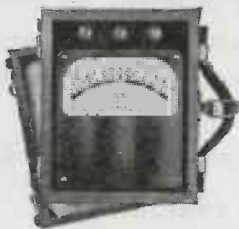

Norton Instruments are precision built to maintain accuracy under exacting conditions. Hand calibrated to meet your exact needs. Widely used in the Electronic Industry for testing and production equipment. Send for catalog.

## NORTON Electrical Instrument Co.

85 HILLIARD ST., MANCHESTER, CONNECTICUT

### Variable Capacitors

Variable capacitors produced by the Hammarlund Mfg. Co., Inc., 460 West 34th St., New York City are illustrated in a new art advertising pamphlet just issued. The text and photographs are designed to emphasize the care in workmanship, excellence in engineering and numerous applications of these products. Seventeen models are illustrated and the availability of special designs is featured.

### Radio Towers

Two new booklets, pretty thoroughly covering the construction, erection and engineering features of radio masts and towers, have been published by Harco Steel Construction Co., Elizabeth, N. J. They include technical data, much information and many photographs of towers and masts in a great variety of heights and types, many of them very easily and quickly erected without skilled help.

### Sub-zero Pyrometer

A new type of pyrometer, designed especially for checking piezoelectric crystals in sub-zero ranges, is illustrated and described in a four-page folder issued by Elematic Equipment Corp., 6046 Wentworth Avenue, Chicago. The instrument is supplied with scales in six ranges to fit all normal requirements.

### WANTED

Sales—Service Engineers  
a  
TEXAS ORGANIZATION  
has the following positions  
available—

a combination  
Sales and Service Engineer  
to contact  
Commercial Broadcast Stations.

Also—a combination  
Sales and Service Engineer  
to contact  
Police—Utilities—Industry  
on  
F. M. Communications.

Also—a combination  
Sales and Service Engineer  
for  
Industrial Sound Equipment.

Also—Salesman  
to contact  
Geophysical Companies.  
(Our present personnel is familiar  
with this advertisement.)

BOX 5577

**ELECTRONIC INDUSTRIES**  
480 Lexington Avenue  
New York 17, New York



# *Sensitive* **SNAP-ACTION**

**...in a new,  
simplified design**

The new, simplified construction of the Struthers-Dunn Type 79XAX Sensitive Snap-Action Relay makes it particularly suitable for a wide range of applications because of its ease of adjustment. Snap-action contacts eliminate the erratic, undependable action normally encountered in ordinary sensitive relays when a slowly varying coil current tends to balance the armature tension spring, and to hold closed the normally closed contacts.

The armature of the 79XAX almost completes its travel in either direction before the contacts snap into the new position. This feature permits an unusually broad range of use from vacuum tube circuits, to overcurrent protection, pulsing circuits, and jobs where extremely close differential or extreme sensitivity of operation is required.

The standard adjustment using 60 ampere turns in the coil at approximately .02 watts results in contact pressures of 5 grams with contacts rated 5 amperes, 115 volts a-c; or 0.5 amperes, 115 volts d-c, non-inductive. Contact ratings up to 10 amperes, 115 volts a-c may be obtained with 100 or more ampere turns and a corresponding increase in power. A sensitivity of 0.005 watts, with 30 ampere turns, is obtainable with reduced contact pressures and ratings, and at an increase in price of the unit.

**STRUTHERS-DUNN INCORPORATED**  
1321 ARCH STREET, PHILADELPHIA 7, PA.

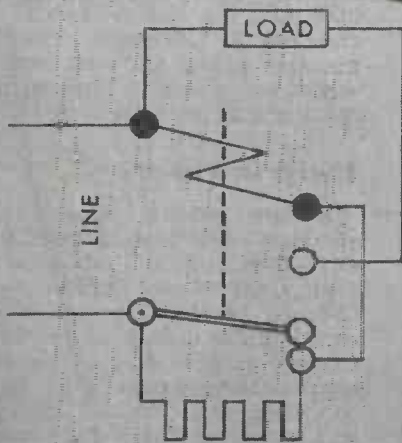

## **A TYPICAL CLOSE DIFFERENTIAL APPLICATION**

In using the Struthers-Dunn 79XAX Relay, extremely close differential between pick-up and drop-out may be obtained for potential operation as shown above. The resistor is chosen so that, when the armature closes, the coil current is automatically reduced to a value just sufficient to hold it closed. Any further decrease in voltage will cause the relay to return to its normal de-energized position as shown.

# STRUTHERS-DUNN

## 5,312 RELAY TYPES

DISTRICT ENGINEERING OFFICES: ATLANTA • BALTIMORE • BOSTON • BUFFALO • CHICAGO • CINCINNATI • CLEVELAND  
DALLAS • DENVER • DETROIT • HARTFORD • INDIANAPOLIS • LOS ANGELES • MINNEAPOLIS • MONTREAL  
NEW YORK • PITTSBURGH • ST. LOUIS • SAN FRANCISCO • SEATTLE • SYRACUSE • TORONTO • WASHINGTON

# LOOKING FOR ENGINEERS

An unusual opportunity to undertake engineering activities in design and development of ultra-high frequency electronic products.

Prior to the war, this Corporation was among the leading producers of Electronic equipment for Industrial application.

Now engaged as Prime Contractors on urgent War Contracts, involving interesting research and development. We need engineers with experience in designing and engineering VHF-UHF Electronic products, and with ambition.

Large projects in the field of Ultra-high Frequency and advanced Electronic applications are scheduled to follow in the post-war period, insuring security and fine environments to all our co-workers.

Write to L. R. Ripley, President, explaining your experience in detail. Your communication will be treated in complete confidence and no further investigation will be made without your express permission.

**United Cinephone Corporation**  
Torrington, Connecticut

## Microphone Types

A new Electro-Voice catalog, with a simplified reference level conversion chart, has been published by the Electro-Voice Corp., 1239 South Bend Avenue, South Bend 24, Ind. Basic operating principles of microphones are explained and new types of special purpose microphones developed for voice and sound transmission are featured. Poly-directional, dynamic, velocity and carbon microphones are described from applications to specifications. Diagrams giving mechanical dimensions and photographs illustrate each model.

## Vacuum Capacitors

An eight-page folder on vacuum capacitors has been issued by Industrial and Commercial Electronics, Belmont, Cal., and includes catalog data on various sizes of units from six to 110 mmfd. The folder includes prices and also brief descriptions of several types of transmitting and rectifier tubes.

## Electric Timers

A new electric timer bulletin (No. 1100) has been released by the C. H. Stoelting Co., Industrial Division, 424-P North Homan Avenue, Chicago 24, Ill. The bulletin describes table and wall model stop clocks, precision chronoscopes, combination timers and impulse counters, stop watch controllers, and spring wound X-ray timers.

## PAX Telephone Systems

A pamphlet descriptive of simplified private automatic telephone systems for general office and factory use has been issued by Kellogg Switchboard and Supply Co., 6650 South Cicero Avenue, Chicago. Systems are available in standard sizes having capacity for handling from 10 to 1,000 lines.

## Radiophone Directory

A directory of 72 pages listing over 1000 Motorola radiophone systems that have been put in use during the past four years has been issued by Galvin Mfg. Co., 4545 Augusta Boulevard, Chicago. Included are the FCC call letters, frequency, power rating and number of units in each installation.

## Silicone Varnishes

Silicone varnish put up in a 50 per cent solution in Solvesso No. 2, a high flash naphtha, is described in a booklet now being distributed by Dow Corning Corp., Midland, Mich. Properties and applications are briefly given and there are included two samples of Silicone treated cloth.

*Transformer  
Engineers  
Devoted to*



## RESEARCH•DEVELOPMENT

● As leaders in the field of design and development of specialized transformers, Electronic Engineering Co. has established an enviable reputation for solving the most difficult transformer applications. With complete electronic laboratories and the finest engineering talent available, Electronic Engineering Co. is devoted exclusively to the production of specialized transformers for the armed forces.

**ELECTRONIC ENGINEERING CO.**  
3223-9 WEST ARMITAGE AVE., CHICAGO 47, ILLINOIS  
"SPECIALIZED TRANSFORMER ENGINEERS"

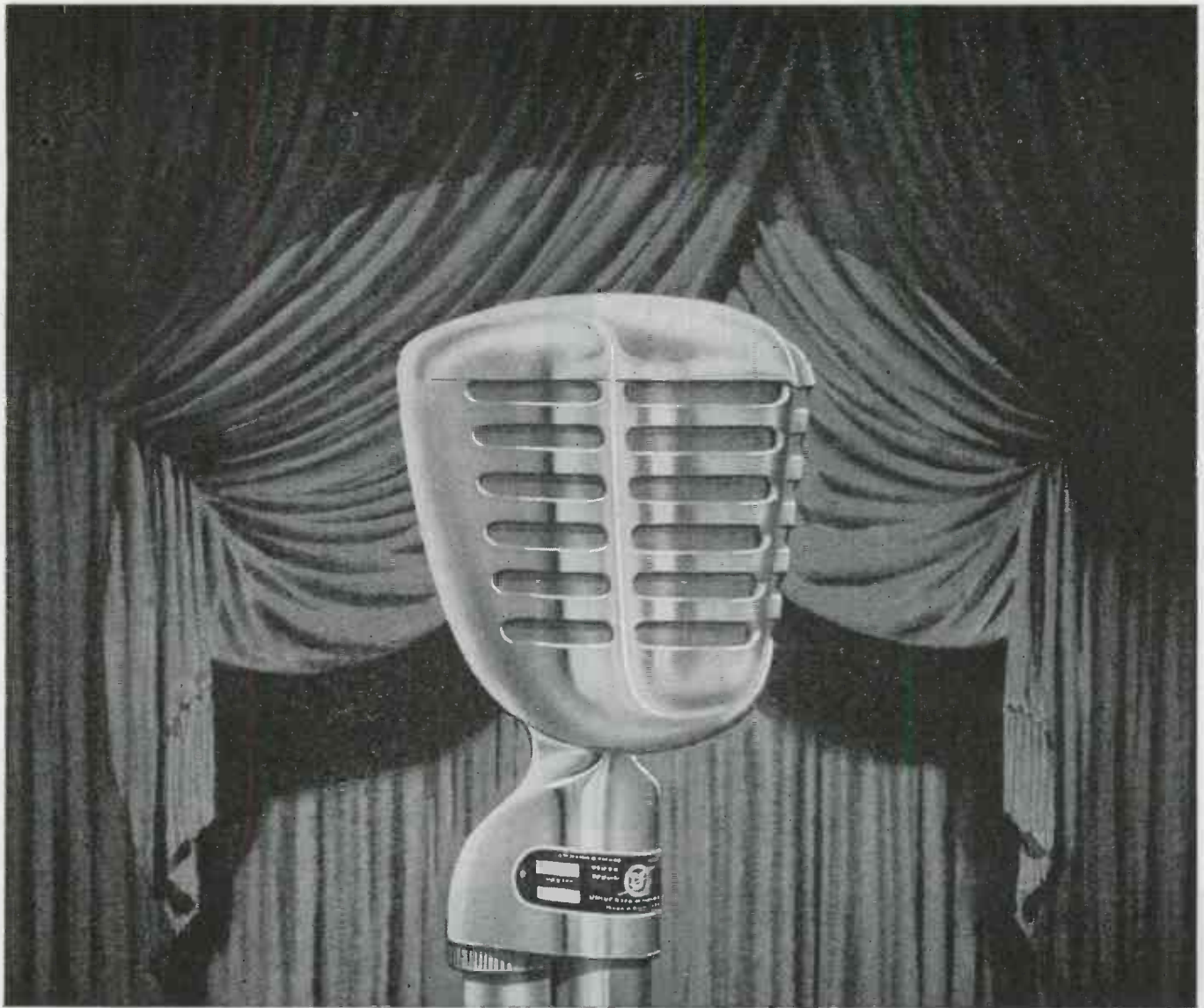

## UNIVERSAL'S NEW D-20 MICROPHONE



The stage was set for something new and here it is. Universal's new D-20 Microphone . . . soon on your radio parts jobbers' shelves to fill your essential requirements . . . uses Universal's "Dynoid" construction . . . A dynamic microphone of conventional characteristics built to fill the utility requirements of war time plus advance styling of the many modern things to come. Orders placed now with your Radio Parts Jobbers will assure early delivery when priority regulations are relaxed.

*Write for Bulletin 1458 covering this new microphone.*

**<FREE** — *History of Communications Picture Portfolio. Contains over a dozen 11" x 14" pictures suitable for office, den or hobby room. Write factory for your Portfolio today.*

**UNIVERSAL MICROPHONE COMPANY**  
INGLEWOOD, CALIFORNIA



# AGASTAT

## ELECTRO-PNEUMATIC RELAY



**COMPACT:**  
4 IN HIGH  
2 $\frac{1}{2}$  IN DEEP  
2 $\frac{1}{2}$  IN WIDE

**WEIGHT:**  
1 $\frac{1}{2}$  POUNDS

ELIZABETH A'G'A NEW JERSEY  
AMERICAN GAS ACCUMULATOR COMPANY

### Electronic Equipment

Concord Radio Corp., Chicago and Atlanta (formerly Lafayette Radio Corporation), has just published a comprehensive 68-page guide book featuring hundreds of items available immediately in single units or in large quantities. It lists and offers standard lines of condensers, resistors, transformers, tools, testers, tubes, and other essential components and equipment. A special feature is the 16-page special values section.

### Threaded Inserts

The Rosan locking system for threaded inserts and studs in metals, plastics and wood is the subject of a four-page pamphlet published by Bardwell & McAlister, Inc., Box 1310, Hollywood, Cal. The pamphlet describes the technical features of the method, gives instructions regarding its use under various conditions, and illustrates many typical applications.

### Load Ratio Control

A voltage regulator for use on power transformers to change taps without interrupting the load and to keep line voltage at proper level is presented in a new bulletin on load ratio control by the Allis-Chalmers Mfg. Co., Milwaukee 1, Wis. The bulletin also shows applications of load ratio control in autotransformers, main windings, grounded neutral, multiple-winding transformers, and with series transformers.

### Induction Heating

Ajax Electrothermic Corp., Trenton, N. J., is distributing an informative booklet describing a variety of applications of induction heating at medium and high frequencies. Applications to large melts of steel and other metals as well as to the heating of small objects are illustrated. Some tables are given indicating relation between size of equipment and time of heat.

### De-Burring Process

A new bulletin describing Roto-Finish, an accurate mechanical process for de-burring and finishing metal parts, has been issued by the Sturgis Products Co., Sturgis, Mich. The bulletin shows how mechanical de-burring and finishing may be performed by one operator, permitting transfer of skilled help to other vital production jobs. Accuracy of the process is illustrated and described, with information presented on the closely controlled cutting actions that provide fine surface finishing to heavy grinding cuts.

## CARTER DYNAMOTORS

*Preferred in World Famous  
Communications Equipment*

THOUSANDS of Carter Products are faithfully providing dependable, efficient service in leading communications equipment all over the globe. Send for latest Catalog of CARTER PRODUCTS Today.

**Carter Motor Co.**  
*Chicago, Illinois*

1609 Milwaukee Avenue

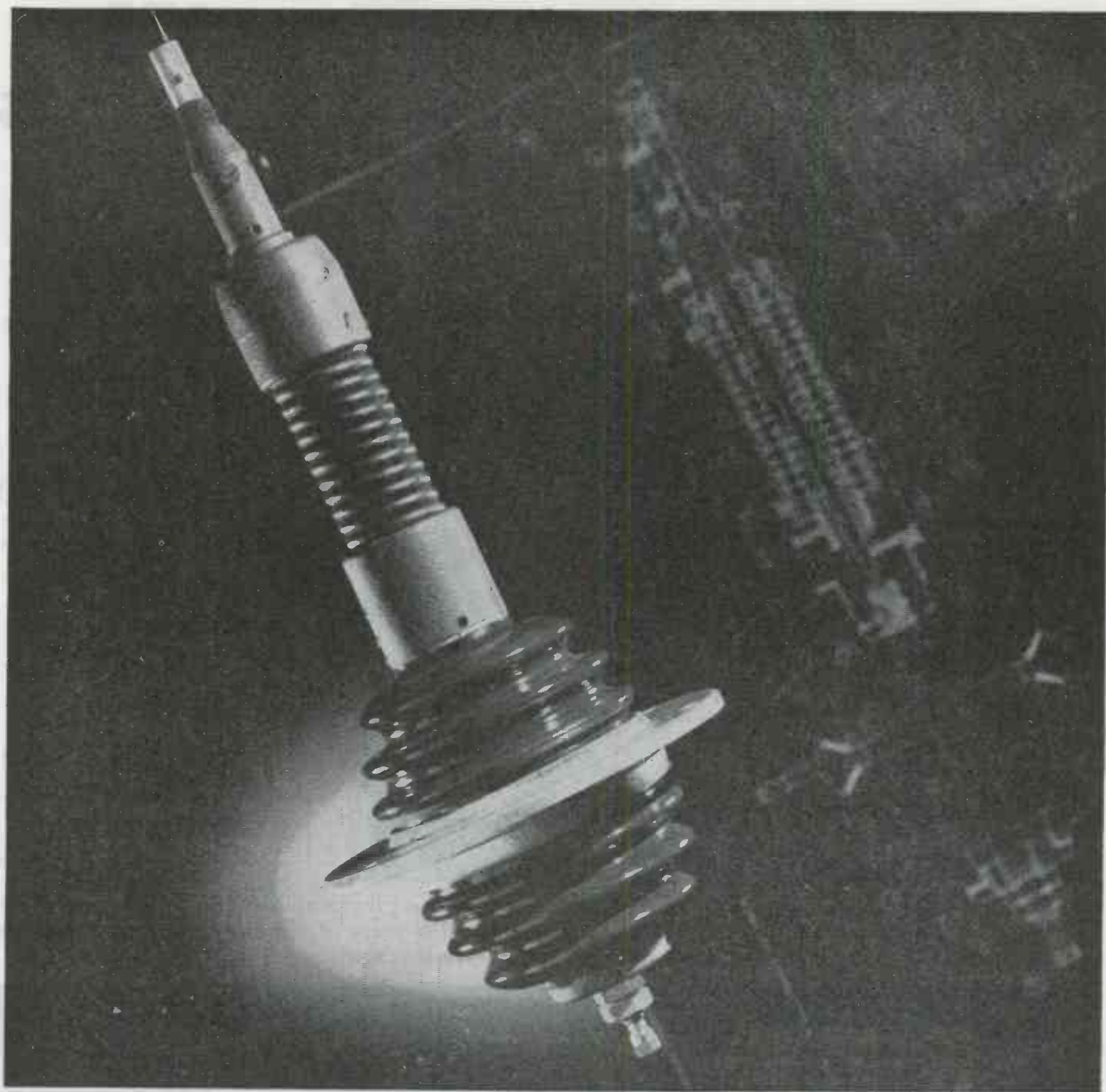

## LAPP-DESIGNED, LAPP-BUILT—TO DO A SPECIFIC JOB

This is an antenna base insulator for use on a communications center transmitter. It is one of several Lapp designs for transmitter and receiver mast bases for military vehicular radio—on jeeps, halftracks, tanks and other rolling equipment.

Whether or not this special-purpose gadget has application to anything you build or propose to build, there's a moral in it for you. In this case, as in hundreds of others, an original and impractical design was modified by Lapp engineers—to provide a part that meets all electrical and mechanical requirements, and that Lapp can build economically and efficiently.

Lapp engineering talent and Lapp production methods are such that we can say, "If it's an assembly that can be made of porcelain or steatite and metal parts, tell us what

the requirements are and how you think it might be made; Lapp will tell you how it can best be made—and will make it." Our right to that claim has been proved over and over in military electronic production; it's going to be a competitive advantage to smart post-war electronic producers. *Lapp Insulator Co., Inc., LeRoy, N. Y.*



# ATR VIBRATORS

## FEATURE:

- Longer Life
- Precision Construction
- Improved Performance

## INCLUDE ALL TYPES:

- Hermetically Sealed
- Light Duty (Auto radio)
- Heavy Duty (Inverter)
- Non-Synchronous
- Synchronous
- Shunt Coil
- Driver Coil
- 6 to 220 Volt D. C. Input

**INQUIRIES INVITED**



ATR Vibrators, the heart of vibrator-operated power supplies, are proven units of the highest quality, engineered to perfection. They are backed by more than twelve years of vibrator design and research, development and manufacturing—ATR pioneered in the vibrator field.

# ATR

*Preferred Precision Products*

- Vibrators
- Vibrator-Operated and
- Rectifier Power Supplies

**ATR LOOKING AHEAD!** Though now engaged in vital war work, with the immediate aim of victory, ATR is looking ahead. Our organization is being geared for the postwar requirements of the Radio-Electrical Industry. At present, only priority rated orders are being filled. However, we suggest that your postwar orders be anticipated and placed with us for prompt delivery after V-E Day. Write for catalog number 244. Backed by 14 years of "know how," **DEPEND ON ATR.**

## AMERICAN TELEVISION & RADIO CO.

*Manufacturers of Quality Products Since 1931*

**ST. PAUL, MINNESOTA, U. S. A.**



# PROTECTION

ALL THE WAY **UP**  
AND **DOWN** WITH

# THORDARSON

HERMETICALLY SEALED  
UNITS



DIRECTION FINDING



RADIO-RADAR



SONIC RANGE FINDER



Thordarson pioneered with multi-terminal glass headers, thus insuring dependable service under all manner of conditions... in the tropics... high in the air... beneath the sea... *complete protection "from top to bottom"*! Your post-war transformers for communications and all types of electronic and industrial services will be available with Thordarson's hermetic seal.



## THORDARSON

TRANSFORMER DIVISION  
THORDARSON ELECTRIC MFG. CO.  
500 WEST HURON STREET, CHICAGO, ILL.

*Transformer Specialists Since 1895*  
ORIGINATORS OF TRU-FIDELITY AMPLIFIERS

# 50th ANNIVERSARY

## JONES 400 SERIES PLUGS and SOCKETS



P-406-CCT

A medium size Plug and Socket that fulfills practically every requirement in the public address, radio and kindred fields. Socket contacts are of phosphor bronze, cadmium plated.



S-406-AB

Plug contacts are of hard brass, silver plated. Insulation is of molded Bakelite. All Plugs and Sockets are Polarized.

Made in 2, 4, 6, 8, 10 and 12 contacts. Caps are of steel with baked black crackle enamel. A quality item at popular prices. Send today for catalog No. 14 listing complete line of Jones Electrical Connecting Devices—Plugs, Sockets and Terminal Strips.

**HOWARD B. JONES COMPANY**  
2460 W. GEORGE ST. CHICAGO 18

## ELECTRONIC PARTS

SEND FOR YOUR COPY OF OUR MASTER BUYERS GUIDE *Now!*

**LONG ISLANDERS**  
*try our*  
**Jamaica Branch**

Whether you need a single Electronic Part in a hurry to finish that Laboratory test . . . or a complete stock for your assembly line.

Call, wire or write **HARRISON**  
Serving the Industry Since 1925

**HARRISON RADIO CORPORATION**  
12 WEST BROADWAY • NEW YORK CITY 7  
Telephone — WOrld 2-6276 • Cable — HARRISONRAD  
JAMAICA BRANCH—172-31 Hillside Ave.—REpublic 9-4102

## World-Wide Organization

Through the formation of a \$2,000,000 corporation uniting their efforts, electronic scientists of International Telephone and Telegraph Corp. functioning in America and numerous other countries will be grouped in a world-wide organization, with headquarters in the



E. M. DELORAINE

United States. Announcement of the corporation, formed in Delaware as International Telecommunication Laboratories, Inc., was made late in March by Colonel Sophenes Behn, president of I.T.&T. and chairman of the board of directors of the new company. The scientific corporation was created to make possible ultimately an exchange of inventions and closer coordination of I.T.&T.'s world-wide electronic research work, including advancements in radio, television, and other branches of the communications arts and the aids to aerial navigation which they will afford in the postwar era.

E. M. Deloraine, internationally known scientist and general director of Federal Telephone and Radio Laboratories, New York, is president of the organization. The corporation is owned jointly by I.T.&T. and a subsidiary, International Standard Electric Corp. Among the other officers elected were Harold H. Buttner and Douglas B. Baker, vice-presidents; Paul F. Swantee, comptroller; O. C. Buchanan, treasurer, and C. Douglas Webb, secretary.

Because International Telephone and Telegraph Corp. has research and development laboratories in New York as well as in London and

Paris and numerous manufacturing companies and communications operating systems in many parts of the world, the need of a single organization to coordinate the scientific work of these widely separated groups is obvious. International Telecommunication Laboratories, Inc., will concentrate upon initiating inventions, developing them, and providing an interchange of information on postwar activities among System Laboratories, and manufacturing and communication subsidiaries.

International Telecommunication Laboratories, Inc., comes into existence against an impressive background of technical accomplishment by I.T.&T. laboratories. In England and France, the laboratories of the associated and licensee companies of the System have made many notable contributions to the advancement of communications.

The New York laboratories of Federal Telephone and Radio Corp., since their formation in 1941, have concentrated on technical development work for the armed forces of the United Nations. These laboratories have made a number of outstanding electronic contributions to the war effort, including the development of marine direction finders designed to meet specific requirements of the United States Navy; direction finders which provide radio bearings for military airplanes; the radio instrument landing system for aircraft now adopted by the U. S. Army Air Force and Civil Aeronautics Administration as standard. They have also contributed aerial navigation systems providing aid to the operation and guidance of airplanes in flight. They have further provided giant 200 kilowatt vacuum tubes for the Office of War Information's powerful new shortwave transmitters.

Although I.T.&T.'s American, French and English laboratories

When the impressive group of buildings that will house International Telecommunication Laboratories is completed the arrangement will look like this. Work will be concentrated on initiating inventions and developing them on a world-wide basis



# PACKED WITH POWER

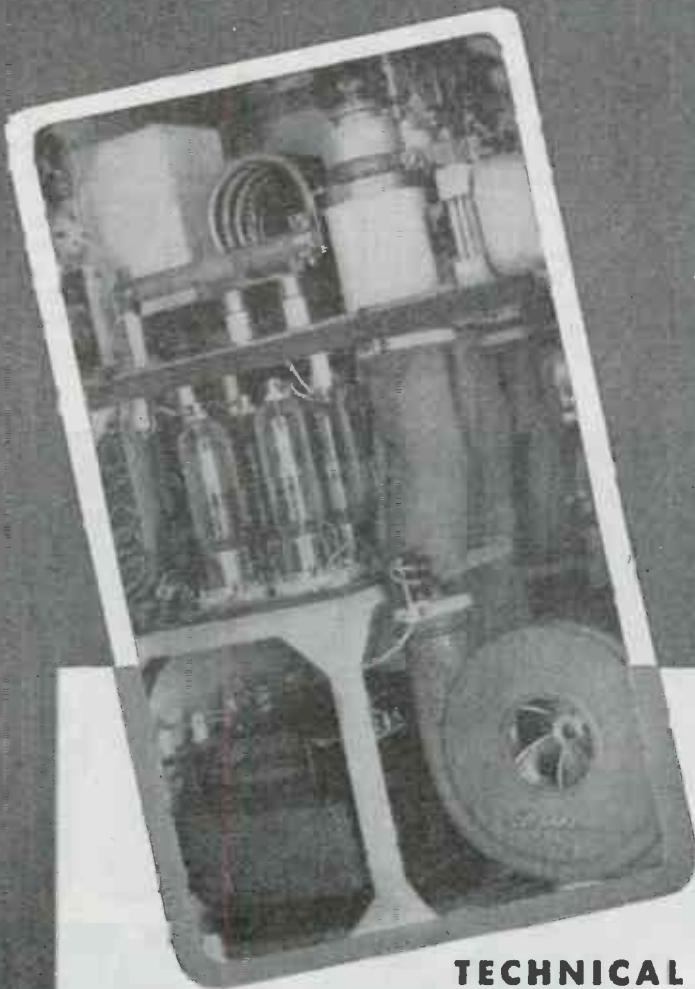

## THE NEW **Thermatron** "HEATMASTER" ELECTRONIC DIELECTRIC HEAT GENERATOR 5 KW OUTPUT\*

Looking into electronic dielectric heating applications for **your** business? Specify the 5 KW "Heatmaster" — get enough power. Many important production savings through use of high frequency heating have been passed up due to insufficient power in making initial tests.

### TECHNICAL DATA

**OUTPUT**—5 KW plus.  
**INPUT**—8 KVA (approximate).  
**LINE VOLTAGE**—220 vol., 60 cycle, 3 phase.  
**FREQUENCY**—30 mc. — 15 mc., 5 mc. optional.  
**HEAT OUTPUT**—Up to 17,000 BTU's per hour.

**OUTPUT CIRCUIT**—Permits heating of loads of widely varying characteristics with a minimum amount of adjustment.

**TUBES**—New long-life external anode tubes.

**SIZE**—24" wide; 28" deep; 59" high.

**WEIGHT**—Approximately 1000 lbs.

Completely self-contained, ready-to-use. A compact power-packed model, particularly designed for heavy-duty where floor space is at a premium. Will heat a 3.3 pound preform in one minute or a 5 pound preform in 90 seconds. Its generous capacity also makes it suitable for rugged general purpose production use as well as research requirements involving substantial power.

Complete specifications of the new THERMATRON "Heatmaster" and other standard models from 500 watts to 30 kilowatts contained in our new circular sent on request. Custom equipment up to 125 KW designed and built.

*\*All Thermatrons rated on output*

## **Thermatron** Division

### **RADIO RECEPTOR COMPANY, Inc.**

251 WEST 19th STREET

NEW YORK 11, N. Y.

Engineers and Manufacturers of Airway and Airport Radio Equipment  
SINCE 1922 IN RADIO AND ELECTRONICS

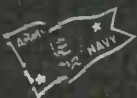

**PREMAX**

*Premax  
Antennas*

**Tested in War...  
Ready for Peace**

**PREMAX PRODUCTS**  
DIVISION OF CHISHOLM-RYDER CO., INC.  
NIAGARA FALLS, N. Y.

The story of Premax in action . . .  
Photos . . . Diagrams . . . Commercial,  
Military, Naval, Amateur . . . just off the press.

*Premax Products*

**Division Chisholm-Ryder, Co., Inc.**  
4503 Highland Ave., Niagara Falls, N. Y.

**El-Menco**  
MOLDED  
MICA  
CAPACITORS



**IMMEDIATE DELIVERY**

ALL SIGNAL CORP ORDERS BEARING  
INSPECTION AT SOURCE; INSPECTED  
ON PREMISES & SHIPPED IMMEDIATELY

All R.M.A. or JAN C-5 color coded  
A complete stock is ready for immediate  
shipment of quantities, ranging from 500  
to 5,000 of each capacity in regular MICA  
CAPACITORS in 5%, 10% and 20% tol-  
erance and silvered MICA CAPACITORS  
in 2%, 5% and 10% tolerances.

Write for  
price sheets and complete information

*Territory  
open for  
JOBBERS*

SEND FOR OUR  
SPECIAL INITIAL  
ORDER OFFER

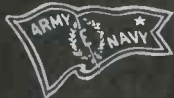

**ALBERT ROTHENSTEIN**  
*National Distributor*  
135 LIBERTY ST. New York 6, N.Y.

are completely engaged today in aiding our war effort, the formation of International Telecommunication Laboratories, Inc., is in anticipation of the important role I.T.&T. expects to play in providing improved international communications in the postwar period.

### **Airplanes Lay Field Wire**

Climaxing months of research and experiment, officials of the Air Technical Service Command and the Bell Telephone Laboratories have revealed in detail their process of laying up to sixteen miles of telephone wire over any type of terrain under battle conditions from a twin-engined C-47 cargo airplane at the Ft. Dix Army Air

Base, New Jersey. In a few minutes the C-47, flying at an altitude of only 200 ft. and a speed of some 125 miles per hour, threw off a 36-in. parachute carrying one end of the wire ballasted with a 20-lb. weight, laid out the wire over a six-mile course, dropped the other end at a designated point, and a conversation was established over the wire.

In the airplane a number of coils of special telephone wire, previously wound by a small automatic machine to look something like a ball of twine at a grocery store, only larger, were lined up across the cargo floor. Cased in wooden boxes, the coils, each holding two miles of wire, were connected to-

*(Continued on page 254)*



Looking inside the airplane at the series of special containers for the reels of wire that are fed out through the pipe illustrated in the lower view

Consult

# KARP

FOR DEPENDABLE SHEET METAL PRODUCTS . . .

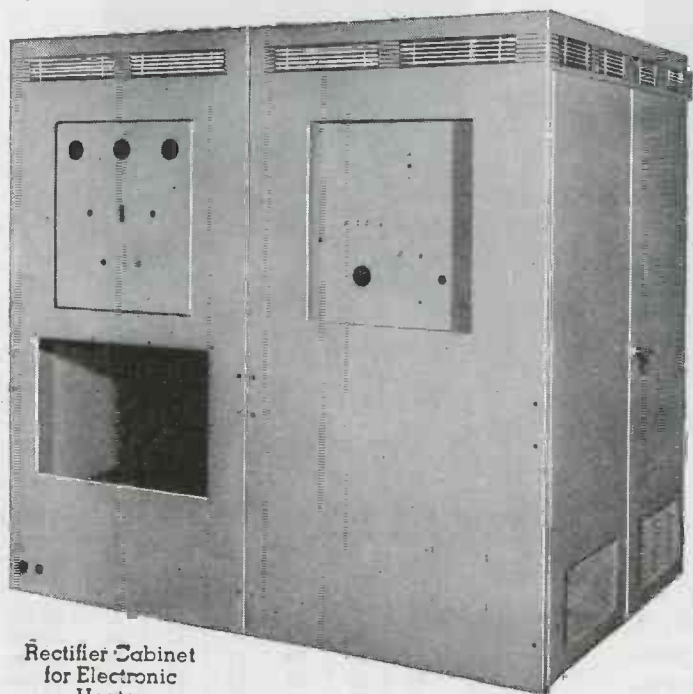

Rectifier Cabinet  
for Electronic  
Heater

**KARP** craftsmen, thoroughly skilled and experienced in sheet metal work, individually construct each job to customers' specifications. Complete, modern facilities make possible any manipulation of the material in all stages of manufacture—from the making of the dies, through the fabricating and finishing. Hundreds of stock dies, already on hand, reduce or eliminate the cost of dies. Moreover, **KARP** goes over your plans with you . . . makes recommendations if they are necessary . . . and suggests means of expediting deliveries. Consult a **KARP** engineer or local sales representative when you require highly dependable sheet metal products—whether they be steel, brass, aluminum, monel, stainless steel or an alloy.



Spare Parts Box with Partitions and Removable Tray



Portable Battery Case



Amplifier Cover

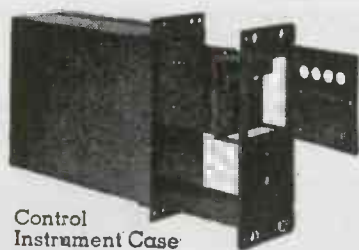

Control Instrument Case (open)



## KARP METAL PRODUCTS CO., INC.

126 30th STREET

BROOKLYN 32, N. Y.

# Specify MALLORY Rectopower<sup>†</sup> Supplies for Dependable DC in Eleven Rated Capacities



COMPACT, rugged and durable, Mallory Rectopower Supplies provide dependable DC power for manufacturing, testing, operating and repairing electrical and electronic equipment. A Rectopower Supply may also be used for economical, efficient taper charging of batteries or battery carts.

Featuring a *variable voltage output*, the Rectopower has low ripple characteristics—3% at full load, lower at light load.

*Long Life—silent operation—rugged construction*—these are characteristics of the Mallory Magnesium-Copper Sulphide Dry Disc Rectifiers used in each Rectopower unit. Completely sealed, with no moving parts, this rectifier assures years of trouble-free service—no maintenance costs.

*Stationary Type Rectopower*—8 Rated Capacities—requires no special foundation and may be quickly mounted in the most convenient location.

## AC INPUT 115 VOLT 60 CYCLE SINGLE PHASE

Type	Volts	Amps.	DIMENSIONS (ins.)				Approx. Weight
			Width	Depth	Unit Height	Height Overall	
6VA10	6	10	14	10	15	18	20 lbs.
12VA10§	12	10	14	10	15	18	32 lbs.
24VA10§	24	10	20	12	15	18	60 lbs.
32VA10§	32	10	20	12	15	18	75 lbs.
6VA25‡	6	25	17	14	24	28	45 lbs.
12VA25‡	12	25	17	14	24	28	72 lbs.
24VA25‡‡	24	25	24	16	24	28	140 lbs.
32VA25‡‡	32	25	24	16	24	28	175 lbs.

‡Fan cooled.

§Can be furnished for dual operation, i.e., half voltage, double current.

## PORTABLE RECTOPOWER SUPPLIES 3 Rated Capacities

TYPE VA1500	TYPE VA3000	TYPE VA4500
AC input 208 or 230 volts, 3 phase. DC output 10-16 volts at 100 amperes, or 20-32 volts at 50 amperes. Size: 18½" wide, 16½" deep, 46" high. Weight approximately 365 pounds.	AC input 208 or 230 volts, 3 phase. DC output 10-16 volts at 200 amperes, or 20-32 volts at 100 amperes. Size: 18½" wide, 16½" deep, 46" high. Weight approximately 375 pounds.	AC input 208 or 230 volts, 3 phase. DC output 10-16 volts at 300 amperes, or 20-32 volts at 150 amperes. Size: 19½" wide, 17½" deep, 48" high. Weight approximately 470 pounds.
460 volt, 3 phase, 60 cycle units available upon request. When ordering specify types VA1500A, VA3000A or VA4500A.		

For complete information, see your nearest Mallory Distributor, or write us today.

<sup>†</sup>Rectopower is the registered trademark of P. R. Mallory & Co., Inc., for rectifier power supply units.

P. R. MALLORY & CO., Inc.,  
INDIANAPOLIS 6, INDIANA

<sup>\*</sup>Rectostarter is the registered trademark of P. R. Mallory & Co., Inc., for rectifier units for use in starting internal combustion engines.

P. R. MALLORY & CO. Inc.  
**MALLORY**  
RECTIFIERS

MAGNESIUM COPPER SULPHIDE RECTIFIERS—  
STATIONARY AND PORTABLE D. C. POWER SUPPLIES—  
BATTERY CHARGERS AND AVIATION RECTOSTARTERS\*



ALL THE

Stability

THE NAME IMPLIES!

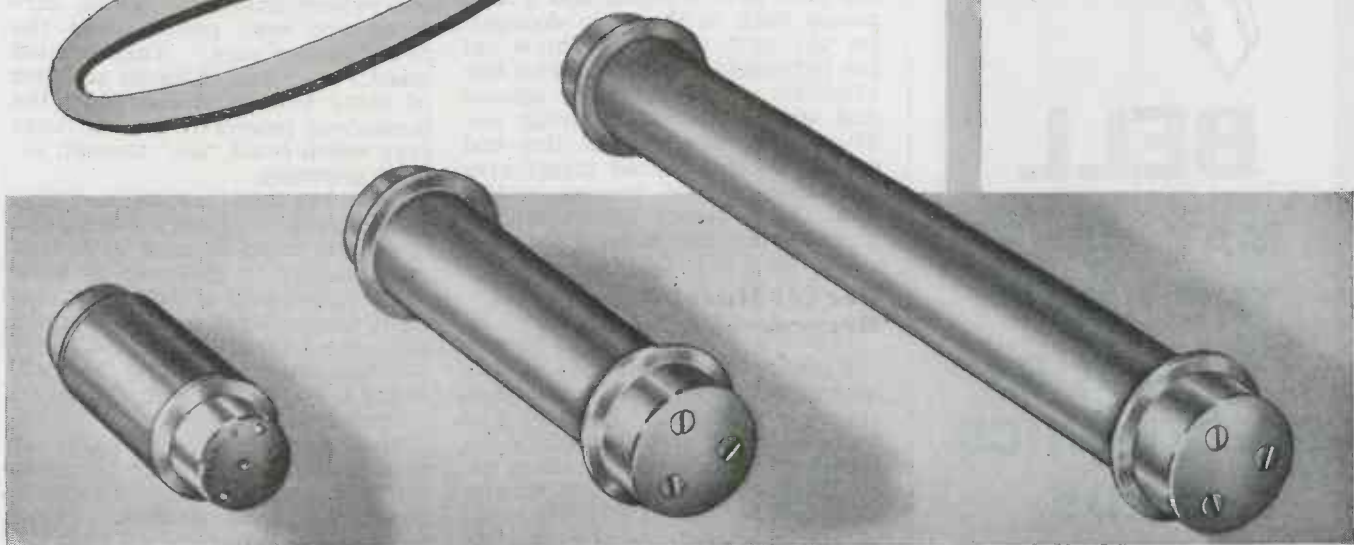

## WESTON TUBULAR RESISTORS

WESTON tubular resistors . . . widely used since their introduction over a decade ago . . . furnish another outstanding example of sound engineering coupled with engineering foresight. For no new 'hurried' resistor design was needed in order to meet exacting military specifications that called for protection against tropical humidity, arctic and high working temperatures, and salt air. The WESTON tubular resistor met these new specifications . . . and in a rugged, non-fragile design tried and proved throughout the years. These resistors conform to and are approved under joint Army Navy Spec. JAN-R-29. Bulletin A-12 gives complete specifications. Send for your copy . . . Weston Electrical Instrument Corp., 666 Frelinghuysen Ave., Newark 5, N. J.

Weston  
Instruments

ALBANY • ATLANTA • BOSTON • BUFFALO • CHICAGO • CINCINNATI • CLEVELAND • DALLAS • DENVER • DETROIT • JACKSONVILLE • KNOXVILLE • LOS ANGELES • MERIDEN  
MINNEAPOLIS • NEWARK • NEW ORLEANS • NEW YORK • PHILADELPHIA • PHOENIX • PITTSBURGH • ROCHESTER • SAN FRANCISCO • SEATTLE • ST. LOUIS • SYRACUSE

In Canada, Northern Electric Co., Ltd., Powerlite Devices, Ltd.

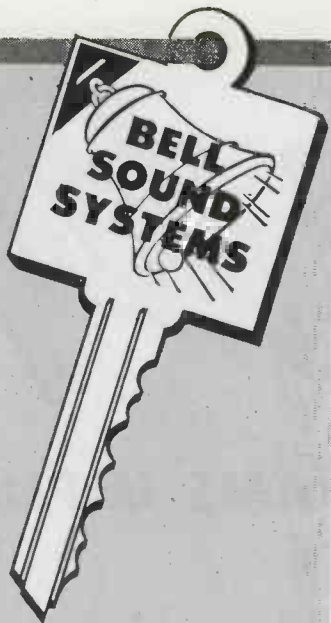

# BELL MAY HAVE THE "Key" TO YOUR ELECTRONICS NEEDS



The right use of electronics may unlock new possibilities for your postwar product, or open the way to new efficiency on your production line. Bell engineers may have the key—the electronic answer—to your needs! BELL's wide experience in designing and building electronic assemblies and controls—from the earliest developments right through to the latest types—qualifies them to serve you. Your inquiry will not obligate you in any way.

AMONG PRESENT BELL PRODUCTS ARE—Electronic Sound Devices — Intercommunicating Systems—Industrial Voice-Paging and Broadcasting Equipment—Permanent and Portable Amplifying Systems—Recording and Disc Playing Units — Electronic Controls — Operating Sequence Recorders — Other Special Devices.

**BELL SOUND SYSTEMS, INC.**

1195 Essex Ave. Columbus 3, Ohio  
Export Off. 4900 Euclid Ave., Cleveland 3, Ohio

(Continued from page 250)

gether. The containers were placed one behind the other in a line extending diagonally across the cargo floor from the doorway forward toward the pilot's compartment.

Beginning with the first container at the doorway, wire from the outer turns of the coil was drawn through container openings and spliced to wire in the core of the second coil. Splicing was repeated between succeeding boxes until all coils were spliced together to form a continuous length of wire.

A short tube was thrust out of the doorway and attached to the front opening of the first box. As the plane approached its target area where the line was to start, the pilot gave a signal and a man moved back to the open doorway. On the next signal he threw out the parachute and weight with line attached. The parachute opened and started the wire paying out. The weight dropped the line end quickly to the desired target area and the pay-out process settled down to a steady thrumming of wire leaving the plane.

## Pocket Model Wire Recorder Designed

A pocket sized recorder using wire magnetization with the Armour Research Foundation principles has been designed in an experimental model. Tentative specifications include a recording time of 66 minutes using a ¼ lb. of 0.004 wire; 2¼ hours of recording time is also possible with a ½ lb. of 0.003 wire. The speed of the wire is 1¼ ft. per second. The experimental unit weighs



Pocket recorder in use shows light weight, compact construction

approximately 3 lb. and has overall dimensions of 7¾ x 4 x 1¾ in. This model records only, does not play back. It is entirely self-contained, being battery operated; a compact microphone which may be held in the hand or worn on a coat or

clipped to the side of the recorder permits convenience in recording speech. After a spool has been recorded on the pocket machine, it is rewound and played back on a standard type of wire recorder playback instrument.

## 50th Anniversary of X-Ray

One hundred years ago March 27, Wilhelm Roentgen, discoverer of X-rays, was born, and exactly 50 years ago, November 8, he made his discovery of that ray which has since proven a boon to mankind and industry. Roentgen called his discovery X-ray because he was at a loss to otherwise define this unknown quantity of great penetrating power. At the time, newspapers everywhere published stories, cartoons and even poems about the new "wonder rays." They printed ghastly skeletons of hands and feet of living persons and extolled the mysterious powers of these strange rays which could "see" through almost anything.

No one at that time dreamed that within half a century Roentgen's invention would be used by American industry in this war to build the toughest kind of fighting equipment—ships, airplanes, guns, tanks and even ammunition—to pulverize German cities, including Munich, where the professor once carried on his research.

Roentgen's discovery makes it possible to detect flaws in ordnance before it reaches the battlefield, reveals such faults in metal as blow holes, tears, shrinkage cavities, inclusions and cracks; faults which could not be detected by the keenest eyes.

Perhaps second to Roentgen in X-ray development is that of Dr. W. D. Coolidge, who until a month or two ago, when he retired, was director of General Electric's research laboratory in Schenectady. The Coolidge tube is world famous, used in hospitals and by industries all over the world.

## Shock-proof unit

The husky glamour boy of industrial radiography today is General Electric's 1,000,000-volt shock-proof unit. In 15 minutes it can inspect steel plates 8 inches thick. A few years ago radium, at \$135,000 a gram, was the only source of the same kind of shortwave-length radiation. Now radiation from this powerful X-ray machine is equivalent to that produced by 8½ lb. of radium, with the machine itself costing only a small fraction of what radium would cost even at the current rate of only \$30,000 a gram.

A year ago, General Electric announced an even larger X-ray, one of two million volts, which will take pictures through 8 inches of steel in one minute. Only two or three of these have been made but results



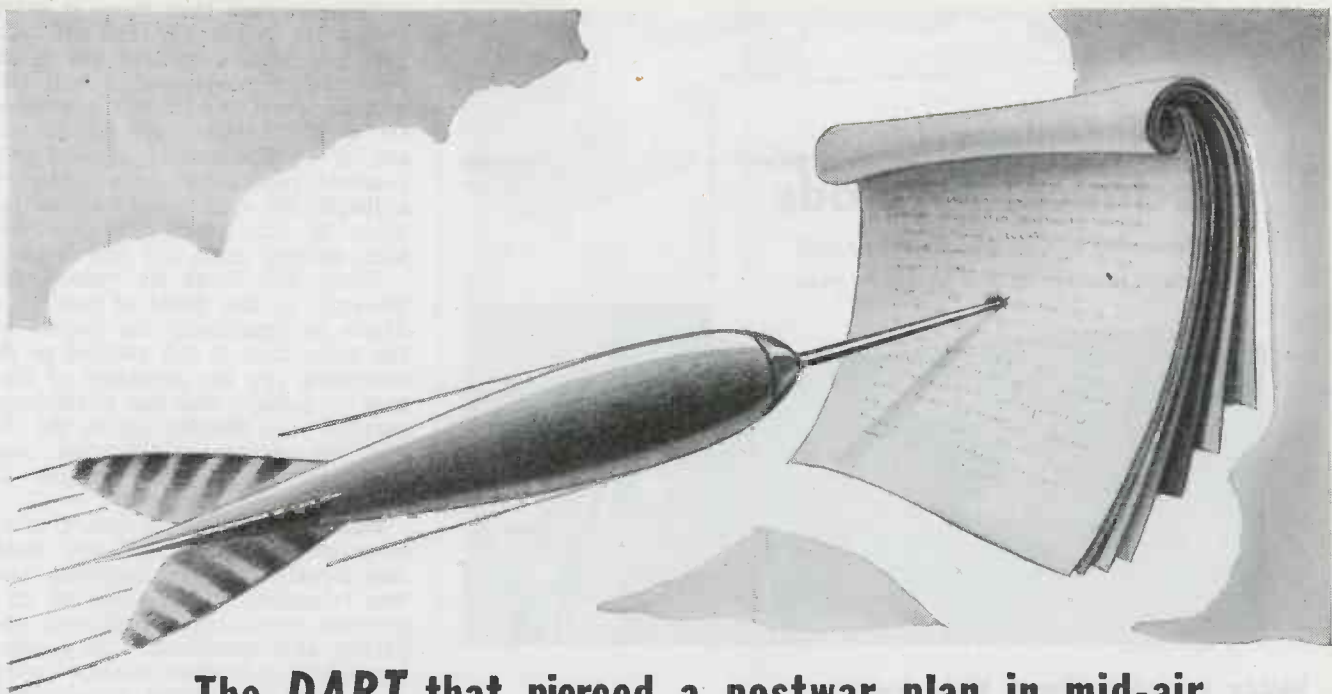

## The DART that pierced a postwar plan in mid-air

Coming in to work on the bus each morning, the man read his newspaper. This morning was no exception. And he smiled to himself as he read the headlines. *Americans Hammering Germany from the West . . . Russians Closing In from the East.* That sounded good. The war would soon be over . . .

As he put away his topcoat and hat, the feeling of satisfaction clung to him. “. . . well, soon as we lick Germany . . .” and he mentally surveyed his own postwar plan.

Even at noontime, when the people of the plant were to be addressed by a young veteran just back from the Pacific, the man was still optimistic. He listened attentively to the stories of brave men and strange lands.

- The khaki-clad youth told his audience about the islands and the jungles and the mountains . . . about fighting and living conditions.
- Calmly, he spoke of the basic nature of the Japanese . . . how they are taught that it is an honor to die for the Emperor . . . and why few Japanese soldiers have ever surrendered.
- And he told of the resentment among many of the men in the Pacific area about the feeling at home that the war would be over—as soon as Germany was defeated. If that was so, why did hell break loose around them every day?

To the man who had smiled at the headlines that morning, these words were the dart that pierced his postwar plans in mid-air. Of course, he had always been conscious of the fact that we were fighting Japan. But that seemed a matter of cleaning up details . . . and good old MacArthur would take care of them. But now, he wasn't so sure. And he began to think. There was more to go, he reflected solemnly, much more to go . . .

*There are many people like this man . . . people who are tempted to forget that Germany's defeat won't mean the end of the war. Military authorities predict that the fight with Japan will be a long, painful struggle . . . perhaps more costly than any we have yet experienced. This, then, is no time for rejoicing. Final victory will be a hard-earned commodity purchased only by consistent working, fighting, sacrificing.*



*American Radio Hardware Co., Inc.*

152 MACQUESTEN PARKWAY SOUTH

MT. VERNON, NEW YORK

MANUFACTURERS OF SHORT WAVE • TELEVISION • RADIO • SOUND EQUIPMENT

HAVE YOU INVESTED ALL YOU CAN IN THE SEVENTH WAR LOAN DRIVE?

## Ingenious New Technical Methods

Presented in the hope that they will  
prove interesting and useful to you.



### Highly Versatile "Pencil Weld Gun" Welds Cold... Corrects Flaws and Defects ... Saves Man Hours, Materials

The Pencil Weld Gun, used with its Vibra-Weld Transformer, offers simplicity and versatility never before known in the industry. Equally effective in correcting flaws and defects in both ferrous and non-ferrous metals—for welding cold, without setting up stresses or crystallization.

Simple in Operation, the Pencil Weld Gun requires but a few moments' practice to achieve results formerly unobtainable with any method. Utilizing a combination of air, high amperage and low voltage, the weld never exceeds 125° to 130° F. The gun uses a pure aluminum or nickel rod, which is applied directly to the defective area. When the surface has been finished and polished off, it is impossible to detect the repair. Easy to use, as gun peens and welds simultaneously. The Pencil Weld Gun and Vibra-Weld Transformer can be used wherever 220 volt single phase electricity and air outlets are available.

Unavailable, however, is Wrigley's Spearmint Gum. As the makers of Wrigley's Spearmint are unable to continue manufacture of the product up to their quality standards under present conditions, the only unqualified protection they can give to the consumer and the dealer alike is to keep the Wrigley's Spearmint wrapper empty. While they advertise this empty wrapper, none is being made and any found on the market is old production of a perishable product.

You can get complete information from  
Mid-States Equipment Company  
2429 South Michigan Avenue, Chicago 16, Illinois



Close-up of new Pencil Weld Gun

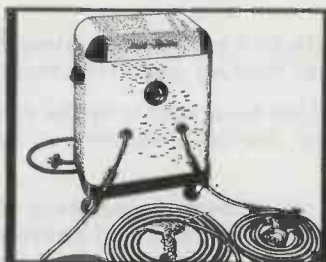

Pencil Weld Gun with Vibra-Weld  
Transformer

Z-66

have been such that there is every indication this bigger tube will soon gain the popularity and use of its one million predecessor. And two million is not the limit, for already Dr. E. E. Charlton and his associate, W. F. Westendorf, also of G-E research laboratory, have perfected a 100,000,000-volt X-ray but particulars of this giant are shrouded with secrecy until the war is over.

X-ray still finds its widest use, however, in the fields of medicine. There is practically no region of the body that is not subject to its searching eye for detection of disease or injury, and the physicians, surgeon and dentist utilize the X-ray for accurate diagnosis and prognosis in a large number of cases.

During the first 20 years after Roentgen's discovery, X-ray work was largely done in hospitals and was relegated to all kinds of employees—electricians, engineers, orderlies and occasionally to a photographer or trained nurse. Today it is done by trained technicians, under the supervision of a radiologist, who is a physician especially skilled in the interpretation of X-ray images of the body, and in other medical uses of X-radiation.

#### Father and son

Robert Machlett, founder of Machlett Laboratories, was an early follower of Roentgen. He developed Roentgen's original discovery to make it one of science's greatest boons to mankind. Robert Machlett died in 1926 as a direct consequence of burns incurred during his experiments in shielding future operators from the destructive force of the X-ray, a true martyr to the cause of science and humanitarianism. His son, Raymond R. Machlett, a Cornell graduate engineer, has followed in his father's footsteps, as head of the company which his father founded, in his own right has probably contributed more to the development of the X-ray than any other living person. Recently, Machlett Laboratories developed and produced the first precision sealed-off 2-million volt X-ray tube. This is but one of many "firsts" attributable to Mr. Machlett's genius as a research engineer and scientist in the field of electronics.

#### Expands research

Since the United States entered the war, Machlett Laboratories, in addition to stepping-up production of shock-proof X-ray tubes for the medical departments of the Army and Navy, as well as those of our Allies, has expanded its research and manufacturing facilities to include the extensive production of highly important secret communication tubes and electronic devices, principally for the Navy. The company was one of the first to receive the coveted Army-Navy "E."

ELECTRONIC INDUSTRIES • May, 1945

## Permanent Magnets

All Shapes, Sizes and Alloys. Alnico magnets cast or sintered under G. E. license. Chrome, Tungsten and Cobalt magnets stamped, formed or cast.

### THOMAS & SKINNER

STEEL PRODUCTS CO. • INDIANAPOLIS, IND.

42 YEARS' EXPERIENCE



# RAYTHEON VOLTAGE STABILIZERS

**Provide Stabilized Voltage  $\pm 1/2\%$  WITHIN 2 CYCLES**

All precision as well as other types of electrical equipment requires steady, uniform voltage for accurate operation. Raytheon Voltage Stabilizers meet this need by providing accurately controlled voltage to  $\pm 1/2\%$  of 1%.

Entirely automatic in operation, the Raytheon Voltage Stabilizer requires no maintenance, no adjustments. Simply incorporate it into new products or equipment already in use and it will take care of itself providing uniformly stabilized voltage.

Raytheon Voltage Stabilizers provide these advantages: Stabilize voltage at any load within their ratings . . . Hold constant varying AC input voltage to  $\pm 1/2$  of 1% — within 2 cycles . . . Control wide AC input variation — 95 to 130 volts. Write for Bulletin DL48-537. It gives the complete story.

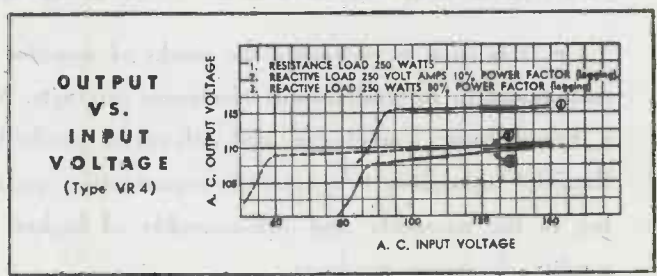
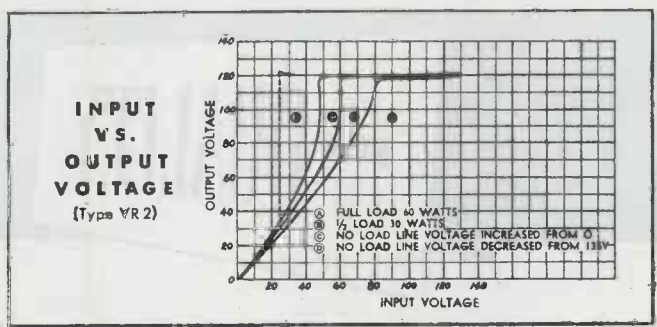

Tune in the Raytheon radio program: "MEET YOUR NAVY," every Saturday night on the Blue Network. Consult your local newspaper  for time and station



# RAYTHEON

MANUFACTURING COMPANY

Electrical Equipment Division  
190 WILLOW STREET, WALTHAM, MASS.

The coveted Army-Navy "E," for Excellence in the manufacture of war equipment and tubes, flies over all four Raytheon Plants where over 16,000 men and women are producing for VICTORY.

Devoted to research and manufacture of complete electronic equipment; receiving, transmitting and hearing aid tubes; transformers; and voltage stabilizers.

on the job for **TIMING PRECISION**



**SIGNALLING**

**TIMER**

A new Timer designed to give the highest degree of precision control. The Series S Timer will command visual and audible attention the instant a time interval is completed. This Signalling Timer provides for the automatic closing or opening of a circuit at the end of elapsed time. As an indication of the versatility of the Signalling Timer, it will also operate additional buzzers, bells or lights at remote locations.

**FEATURES OF SERIES S SIGNALLING TIMER**

**Rugged construction**  
**Compact—**  
5 x 5 x 3 1/2 inches

**Dial calibration 1 second**  
to 5 minutes  
**Maximum Interval 1 minute**  
to 3 hours

**Motor, slow speed—**  
self-starting  
**Pure silver contacts**

Write for Bulletin A14

**INDUSTRIAL TIMER CORPORATION**

110 EDISON PLACE



NEWARK, NEW JERSEY

FOR **QUALITY**

**RADELL-BUILT PRODUCTS**

• It is easy to recognize the marks of superior craftsmanship in Radell-built electronic products. With a broad basic knowledge and advanced production skill, Radell Corporation is a versatile organization specializing in the assembly and sub-assembly of highest quality electronic products.

**COMPLETE FACILITIES FOR AUDIO WORK**

**RADELL** CORPORATION

6323-37 Guilford Avenue, Indianapolis 5, Indiana

**“Variety” Plugs Engineers**

Radio is set to enter a new era, what one prominent radio man calls the “engineering cycle,” as soon as the war’s over, reports “Variety,” theatrical newspaper, in its usual breezy style.

Dozens of top ranking engineers who are in the armed services or engaged in warplant activity, says the publication, are being tabbed quietly by networks and independents alike for some of the highest paid jobs in the industry. The scramble for this valuable talent is already under way, although in some instances the engineers concerned are not themselves aware that a fat contract awaits them as soon as it looks they may be free to listen to an offer from private civilian, non-war enterprise.

Radio biggies will agree, although off the record, that the industry had gone through an engineering slump that set in in the late twenties.

**“Cycle” reckoning**

Allowing for individual deviations, the “cycle” reckoning stacks up something like this: The twenties was the era of radio engineering “growing pains,” and much was accomplished in bridging the gap between the one-lunger and the 50,000-watter on the transmission end, as well as between the crystal set and superheterodyne in reception.

“But once that period of early experimentation and improvement was over,” said one prominent radio man, “the industry settled back on its haunches and let the commercial boys take over.

“If you examine radio’s record in the thirties, you’ll find that was the second phase, the era of the advertising salesman and business promoter. In a way, no one was to blame. Industry had invested heavy dough in developing radio; it was entitled to a break. But the pendulum had certainly swung too far. Public service was given only lip service. Engineering development was at a minimum, except in laboratories where the public hadn’t the slightest inkling about the exciting new processes under development.

**Strict security**

“By the end of the thirties, both the engineer and the program director started to come back into their own. But then the war period came. Even before we were actually in the war, all radio engineering experimentation had to be put under strict security wraps.

“The war has helped radio tremendously. Not only because, like so much other business, it made profits—allowing it to reinvest surplus profits in public services. It helped programmatically because



# ARAT ISN'T DEAD WHEN HE'S CORNERED...

That's when he begins to fight—*desperately*.

This war isn't won yet—even though we have the two-legged rats cornered.

It's going to take a lot of hard blows before they're knocked out for keeps.

Our boys aren't letting up over there—Don't let them down over here.

Buy *bonds* and more *bonds*.

Give *blood* and more *blood*.

Stay on your war job—

Until the last shot is fired.

\*\*\*\*\*  
Here at Kenyon, we're proud to play our small role on the stage of a BIG war. That's why EVERY Kenyon transformer used by our fighting forces throughout the world reflects only the highest precision craftsmanship. Kenyon workers are doing their share — bringing Victory closer by turning out top quality transformers uninterruptedly—and as fast as possible!  
\*\*\*\*\*



THE MARK OF

EXCELLENCE

**KENYON TRANSFORMER CO., Inc.** 840 BARRY STREET  
NEW YORK, U. S. A.



## HELPING SOLVE MICROPHONE PROBLEMS IS HIS BUSINESS!

The Turner Company is proud of its thoroughly experienced staff of representatives. This competent group is qualified in every field of microphone application. These men are ready to study your electronic communications problems NOW. You are invited to call in your nearest Turner Representative for expert advice and suggestions in selecting the right microphone for your purpose. He is at your service whether you need job lots or single units. Call him today!

### BOSTON

Henry P. Segel Co.  
221 Columbus Avenue  
Boston, Mass.

### GREELEY

Gordon G. Moss  
P. O. Box 428  
Greeley, Colorado

### LOS ANGELES

David N. Marshank  
Marshank Sales Co.  
2022 West 11th St.  
Los Angeles 6, Calif.

### CHICAGO

Royal J. Higgins  
600 S. Michigan Avenue  
Chicago 5, Ill.

### HENDERSONVILLE

Herb Erickson Co.  
P. O. Box 179  
Hendersonville, N. C.

### MILWAUKEE

Irvin I. Aaron  
4028 N. 16th St.  
Milwaukee 9, Wisc.

### CLEVELAND

Earl S. Dietrich  
707 Hanna Bldg.  
Cleveland 15, Ohio

### JENKINTOWN

D. M. Hilliard  
Box 246  
Jenkintown, Pa.

### NEW YORK

Wm. Gold  
53 Park Place  
New York 7, N. Y.

### DALLAS

Ernest L. Wilks  
1212 Camp St.  
Dallas 2, Texas

### KANSAS CITY

Edw. B. Lundgren  
516 Mfgs. Exch. Bldg.)  
Kansas City 6, Mo.

### SEATTLE

Verner O. Jensen Co.  
2607 2nd Avenue  
Seattle 1, Washington

### DETROIT

Fred J. Stevens  
15126 E. Warren Ave.  
Detroit 24, Michigan

### MONTREAL

Sni-Dor  
Radioelectric Ltd.  
455 Craig St., W.  
Montreal, Quebec

EXPORT REPRESENTATIVES

AD AURIEMA, INC.

89 Broad Street, New York 4, N. Y.

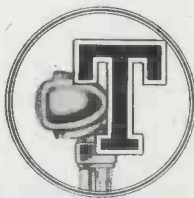

# The TURNER Company

C E D A R R A P I D S , I O W A

Pioneers in the Communications Field

the American listener had become accustomed to finer, and more consistent public service programs—and he will have to continue getting it after the war, or he'll let us hear from him in no uncertain terms. And the war has brought about tremendous progress in radio engineering.

"The program director and the writer are already in their own now, and will keep their place after victory. Parenthetically, some of the biggest names in radio have found out how dependent they are upon writers suddenly yanked away from them by the armed services—and the writer, from here on in, is going to command greater respect than ever.

"But on the engineering end, the biggest things are going to happen after the war—and the engineers are going to be topdog in radio. Some people in radio are trying to kid themselves by saying that there are no new real developments, of real value to industry as a result of the war. They are either deluding themselves—or are trying to delude others.

### Secret hearing

"In Washington, recently, the FCC had six members of the radio industry sit in on a secret hearing where Government engineers really told something. Of course, the six men were sworn to secrecy, and are maintaining silence. But all you have to do is watch the faces of these men when you talk to them about new developments. They don't say anything, but you know they're hep to plenty.

"That's why, very quietly, radio people are out scouting for the best engineering talent they can acquire for postwar work. The engineers will be able to write their own ticket. The new era, the engineering cycle, is going to be the biggest thing in radio yet."

### Plated Coatings

Some ten or twelve metals and alloys are in extensive commercial use as electro-plated finishes, reports H. L. Farber, Westinghouse Electric & Mfg. Co., Mansfield, Ohio.

The choice of a given kind of plated coating depends to a large extent on the application or use to which the plated article is to be put. Plating coatings are used for decoration, protection or mechanical reasons, or a combination of purposes. More specifically, a coating may be used essentially for appearance and show; for protection from corrosion or rust; for some mechanical or special purpose such as wear resistance; or for building up an area to correct dimensions or possibly as a suitable surface for soldering or brazing to other parts.

# 25 YEARS

*Specialization in*

# RELAYS

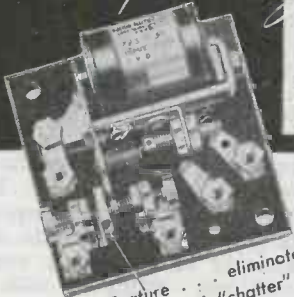

New Feature . . . eliminates "bounce" and "chatter"



Microphone Hummer

Twenty-five years' experience in solving all types of Relay Problems . . . Complete facilities for Designing, Engineering, Manufacturing . . . Specialists in producing Relays of exceptional power and sensitivity for Aircraft, Intercommunications-Systems, Electronic Devices. Exclusive Kurman features provide greater dependability, longer life, more precise performance . . .

Send data for quotations. Write for new descriptive Bulletins.

## KURMAN ELECTRIC CO.



35-18 37th STREET • LONG ISLAND CITY 1, N. Y.

MacRae DOES A GREAT JOB • MacRae  
 MacRae DOES A GREAT JOB • MacRae  
 MacRae DOES A GREAT JOB • MacRae  
 MacRae DOES A GREAT JOB • MacRae  
 MacRae DOES A GREAT JOB • MacRae  
 MacRae DOES A GREAT JOB • MacRae  
 MacRae DOES A GREAT JOB • MacRae  
 MacRae DOES A GREAT JOB • MacRae  
 MacRae DOES A GREAT JOB • MacRae  
 MacRae DOES A GREAT JOB • MacRae



For advertising and book rates consult your agency or write  
**MacRae's Blue Book**  
 A DIRECTORY OF AMERICAN INDUSTRY  
 79 E. HURON STREET CHICAGO 11, ILL.

# Kahle

## ENGINEERING COMPANY ELECTRON TUBE MACHINERY

All types, standard and special design.

Specialists in equipment and methods for the manufacture of:

- |                    |                |
|--------------------|----------------|
| RADIO TUBES        | NEON TUBES     |
| CATHODE RAY TUBES  | PHOTO CELLS    |
| FLUORESCENT LAMPS  | X-RAY TUBES    |
| INCANDESCENT LAMPS | GLASS PRODUCTS |

On Production or Laboratory basis

1307-1315 SEVENTH ST., NORTH BERGEN, N. J., U. S. A.

### PRODUCTION MANAGER

#### Unusual Opportunity for Unusual Man

A well-known manufacturer of high quality radio sets and electronic equipment requires a man with a good basic knowledge of electronics production and planning. He will have complete charge of our plant, and will get all the cooperation he needs to do his job efficiently. We are prepared to offer an interesting proposition, present and post-war, to the right man. Please provide background and full particulars in first letter. Box 5526.

ELECTRONIC INDUSTRIES  
 480 Lexington Avenue  
 New York 17, New York

Small Capacity—  
Individual  
Operator



# SOLDER POTS

for  
110 volt  
AC or DC



Available in two sizes—Model 200 with 1 3/4 pound capacity and Model 250 for 2 pound melts. They are particularly adapted to tinning small wires and leads, and similar operations. A single-heat, porcelain nickel-chrome heating element heats the pot. Element can be quickly and inexpensively replaced when necessary. Can be had for 220 V. operation. Low Cost! Economical! Efficient!

**LECTROHM**  
INCORPORATED

5139 West 25th Street, Cicero 50, Illinois  
 Division of The National Lock Washer Co., Newark, N. J.

# CONSIDER THE NEW DRAKE No. 75 AP

*Underwriters Approved!*

TRADE demand has caused Drake to produce this new totally enclosed candelabra screw base 1" pilot light assembly. The unit is approved by the underwriter's laboratories for 75 watt, 125 volt service. Designed to house the Mazda S6, 110 volt, 6 watt candelabra screw base lamp. Can be supplied with lamp installed. The unit mounts in a 1" hole and is regularly furnished with a 1" diameter faceted colored glass jewel. It is also supplied with a steel lock washer which holds the unit firmly to the panel. Mounts on any thickness panel up to 1/2".



Although designed to operate on 110 volt circuits, this assembly can readily be used on 220 volt circuits by connecting our #116 wire wound resistor in series with the pilot light.

Lamps are easily removed with our S6 lamp remover. Anyone who has to maintain, or install in production, large numbers of S6 lamps, will find the S6 lamp remover a great convenience.



## Socket and Jewel Light Assemblies

# DRAKE MANUFACTURING CO.

1713 WEST HUBBARD ST., CHICAGO 22, U.S.A.

# WOKMAR

*Manufacturers of*

**RADIO, ELECTRICAL AND  
ELECTRONIC COMPONENTS**

**ELECTRONIC PRODUCTS MFG. CORP.**  
DEXTER, MICHIGAN

Specialized coatings are used for heat resistance or to resist chemical attack by foods or drugs.

Protective plated coatings may be divided into two classes depending on the method of preventing corrosion. Cadmium and zinc are used extensively on parts where appearance is not important but where extremely good resistance to rust is desired. These metals are anodic to the base metal and are sacrificed in themselves. The life of such coatings is nearly a linear function of time in the salt spray or corrosive atmosphere to which they are exposed, and depends on thickness of deposit used. This type of coating is usually required on parts which are subject to outdoor exposure or extremely corrosive conditions. Films of .0005 in. or less are usually sufficient.

### **Shield for base**

Resistance to corrosion is also afforded by a number of other plated metals which are more inert in themselves and serve as a shield for the base metal. Nickel, copper, chromium, tin, silver and gold represent this class of protective films. The finishes of this type must be essentially pore free in order to afford protection to the base metal. Thicker coatings are usually required for good protection; films of .0005 in. or more often—.0010 in. thickness being required. Due to its chemical inactivity this class of coatings is useful in affording good protection in addition to better appearance over long periods of time. However, due to their toxicity, rate of change, and low melting and oxidizing temperatures, cadmium and zinc are not desirable for many uses. Food handling equipment is usually finished with tin or one of the other metals of that type.

The base metal composition and the size and shape of the part determines to some extent the type of plating metal to be used. Some metals are not plateable or require special processes. The aluminum and zinc metals and their alloys are in this class. Other finishes are sometimes more desirable on these metals as, for example, anodizing for aluminum Cronak treatment for zinc.

### **Surface properties**

The surface properties of some base metals preclude the use of certain types of plated coatings. Bright nickel and zinc plating, for example, do not always work to advantage on cast iron parts. Chromium alloys are difficult to plate with most metals except chromium. The size and shape of a part should receive some consideration in choosing a plated coating. This is important since current requirements and throwing power vary with different metals. Cadmium, which



# WANTED!!

by

## LARGE EASTERN TRANSFORMER MFR.

- **EXECUTIVE ELECTRICAL ENGINEER** experienced in the sales and manufacture of magnetic components for Fluorescent and Cold Cathode Lighting.
- **ELECTRICAL ENGINEER** experienced with the design of Ballast and Cold Cathode Transformers.
- **EXECUTIVE ELECTRICAL ENGINEER** experienced in the sales and manufacture of Transformers utilized for the Radio Receiving Set Industry.
- **ELECTRICAL ENGINEER** experienced in the design of Transformers and Reactors for the Radio Receiving Set Industry.

*These positions are permanent, offering excellent Post-War opportunities in a forty-year old transformer manufacturing company. Address replies to*

BOX 5548, ELECTRONIC INDUSTRIES  
480 Lexington Avenue New York 17, New York

**WMC RULES PREVAIL**

## ENGINEERS

wanted for opportunities in modern Long Island mfg. organization. Products are navigation and aircraft instruments, radar and electronic equipment. Experience in similar fields required. Applications invited from electrical, mechanical and tool designers; research, product, project, transformer and motor Engineers. Electrical engineering or mechanical engineering training important. Salary commensurate with experience and ability. Midwest interviews where desired. WMC rules apply. Send complete information about self in first letter.

### SPERRY

GYROSCOPE CO., INC.

Mail Station IW4

81 WILLOUGHBY ST., BROOKLYN 1, N. Y.

Harness  
our ingenuity in  
wiring technique to  
your production  
problems

**MILLER ELECTRIC CO.**

Doing unusual things with wire for war  
127 HIGH STREET • PAWTUCKET • R - I •

# INCREASE PRODUCTION

*with*

# SOUND!

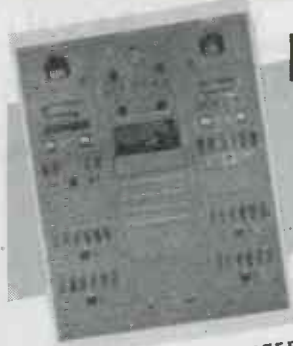

PLANT BROADCASTER



## LET OUR ENGINEERS SHOW YOU HOW!

**E**MERGENCY SERVICE  
Sound Engineers have many successful industrial installations to their credit. Again and again they have demonstrated the amazing efficiency of our Sound Equipment installations to increase production and to promote the safety and happiness of workers. Take advantage of the unusual skill and experience of our sound engineers and our extensive stocks which include all leading, nationally known lines of fine Sound Equipment. Let them show you the need for a Sound System in your plant. The coupon mailed today will quickly bring you complete information.

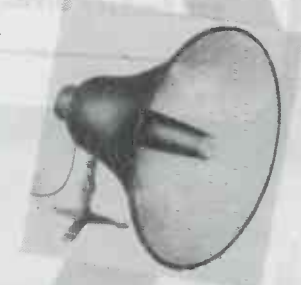

SEND FOR THIS NEW BUYER'S GUIDE

**WALKER-JIMIESON, INC.**

311 S. Western Avenue, CANal 2525, CHICAGO 12

**RADIO SPECIALTIES CO.**

20th & Figueroa, Phone Prospect 7271, LOS ANGELES 7

GENTLEMEN: Please mail me free copies of your booklets on Sound Equipment, and your latest Catalog.

NAME \_\_\_\_\_

COMPANY \_\_\_\_\_

CITY \_\_\_\_\_ ZONE \_\_\_\_\_ STATE \_\_\_\_\_

FOR POST WAR REQUIREMENTS

40 YEARS OF EXPERIENCE AT YOUR SERVICE

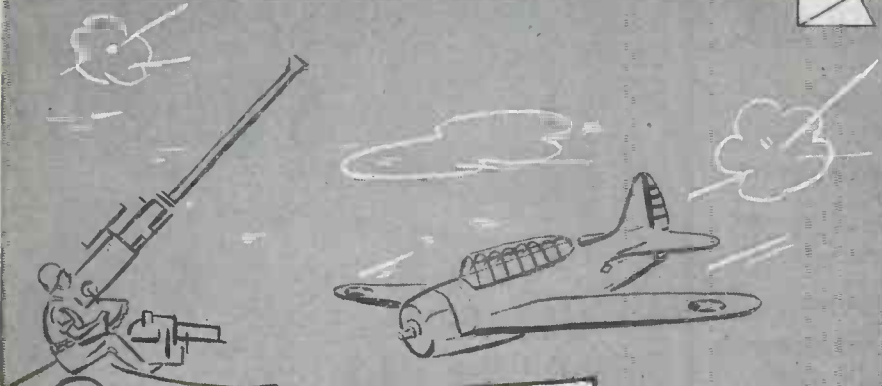

*Willor Makes It!*

... and makes it with a high degree of precision and cooperation born of our concentrated experience in meeting wartime's rigid requirements and schedules. From raw stock to completed items ... Willor service embraces every facility for planned production.

*We Invite Inquiries and Blueprints*

- METAL STAMPINGS
- MACHINE WORK
- LAMINATIONS
- TOOLS AND DIES
- PANEL BOARDS
- PLASTIC PARTS
- MECHANICAL AND ELECTRICAL INSTRUMENTS

**WILLOR**  
MANUFACTURING CORP.

288 Eastern Blvd., New York (54), N. Y.

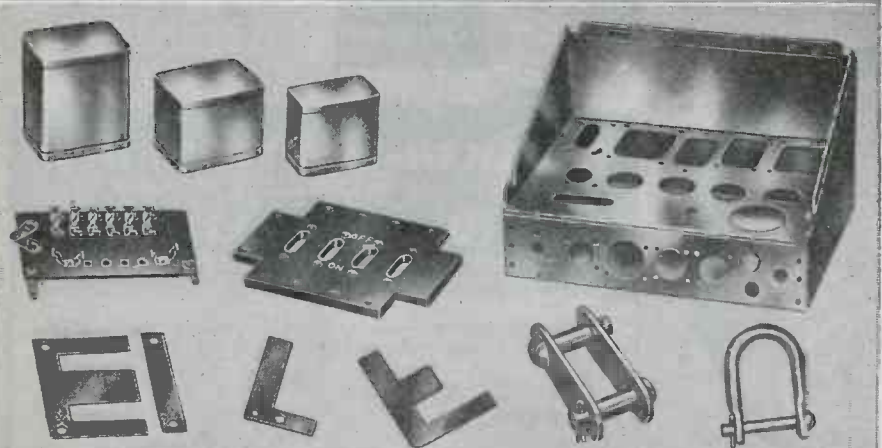
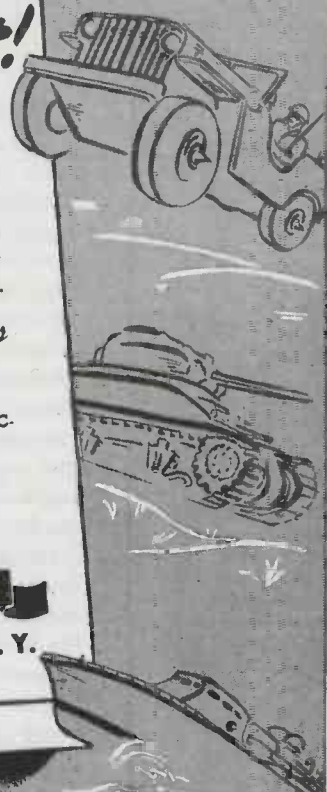

BACK THE ATTACK -- BUY MORE WAR BONDS

costs 95c per lb., has better throwing power than zinc, which costs 16c per lb., and may be more economical in overall cost when used on irregularly shaped parts where special racking and inside or auxiliary anodes are necessary in order to use zinc.

The corrosion properties of the base metal must be considered in choosing the coating. Parts made from non-ferrous metals, such as brass and copper, will normally require less protection than those made of iron or steel.

**Cost of finish**

Another important factor in choosing plated coatings and finishing systems is the cost of the finish to be used. On the basis of metal cost alone, the different metals cover a range of from 6c for zinc to \$50.40 for gold for coatings of one thousandth of an inch on a square foot area. Theoretical metal costs are not the complete story in plated finishes since the labor and chemicals used in the operation usually represent more cost than the metal deposited. It costs 46c to apply the nickel and chromium finish on an electric iron but of this amount 20c or 44 per cent is for grinding and polishing, 2.7c or 6 per cent is for plating materials, 6.5c or 14 per cent is for plating labor, 17.1c or 36 per cent is for buffing and coloring. The size, shape and special requirements of a given part are a factor in the plating cost. On a small zinc plated fuse part where the plating requirements are high and the parts intricate in shape, the finishing cost for metal is less than that for other materials used in the operation and much less than that for plating labor.

**Electrical Engineers Continue to Be Needed**

The United States Civil Service Commission is making an extensive recruiting drive to provide electrical engineers for essential war work in the Signal Corps, in the Bureau of Ships of the Navy Department, in offices of the Rural Electrification Administration, and in various Federal agencies in Washington.

Engineers are needed principally for positions which pay \$2,433, \$3,163 and \$3,828 a year, with overtime pay. Positions paying salaries higher than those mentioned are usually filled by promotion from within rather than by recruitment from outside sources. Experience in the appropriate field of electrical engineering is required in varying amounts, according to the grade of the position. Engineering education may be substituted for all or part of the experience.

In the Signal Corps, radio and electronic, telephone, and telegraph

THE GRAYHILL ROTO-SWITCH HAS BEEN DESIGNED FOR MULTIPLE CONSTRUCTION UP TO 12 POLES, 11 CONTACTS, OR 132 CIRCUITS. THE SOLID SHAFT ASSURES POSITIVE POLE ALIGNMENT IN RELATIONSHIP TO CONTACTS. BULLETIN #101 WILL GIVE YOU FURTHER INFORMATION.

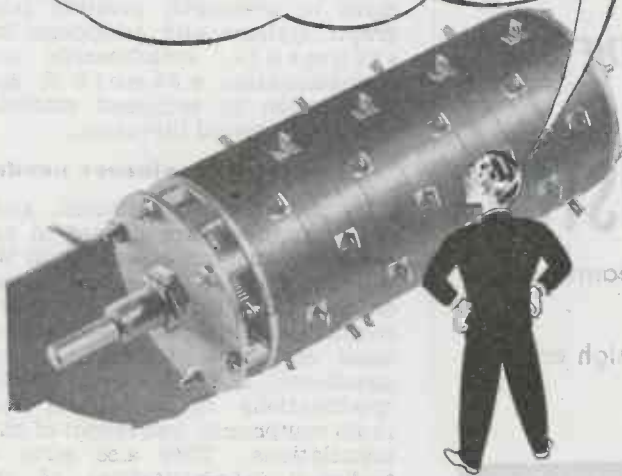

*Grayhill*

9 North Pulaski Road, Chicago 24, Illinois

### OPPORTUNITIES in Present and Postwar Work

Senior and Junior graduate Engineers with one or more years radio experience wanted by an expanding manufacturing division of an established Communication Company. Also, Engineers with practical experience for radio communication plant installation and test in foreign countries. Phone, call or write stating experience, education, present salary, etc., to:

**PRESS WIRELESS, INC.**  
**HICKSVILLE, L. I.**  
ATT: S. A. BARONE, CHIEF MFG. ENGR.

**TERMINALS**  
for  
ELECTRIC WIRES  
**SMALL METAL STAMPINGS**  
in accordance with your blueprints

**PRECISION PARTS**  
from Modern Equipment

**PATTON-MacGUYER CO.**  
17 VIRGINIA AVENUE      PROVIDENCE 5, R. I.

# GRACOIL

"One Good Turn - or a Million"

## A NAME TO LOOK FOR on ELECTRICAL COILS and TRANSFORMERS

Famous for years as  
"COILS by DOYLE"



LAYER-WOUND COIL



LDW VOLTAGE  
TRANSFORMER



GENERATOR  
FIELD COIL



RELAY COIL

★ "GRACOIL" is a new name that you can depend upon, because back of this name stand years of time-tested experience in electrical engineering. The same able craftsmen who established Doyle Coils as leaders in the field now carry on at the same location under the new corporate name—The GRAMER Company.

Be sure that the coil you buy bears the trademark name—"GRACOIL", for only then can you know that you have the best in electro-magnetic windings. Every "GRACOIL" is wound to the specified number of uniform turns from precision-gauged wire. Every "GRACOIL" is fully insulated, thoroughly impregnated, and properly laminated when supplied as a complete transformer. The most rigid inspections and tests make sure that each "GRACOIL" is worthy of the name it bears.

If your design calls for a special electro-magnetic application, let competent "GRACOIL" engineers make specific recommendations for you. Write today!

# GRACOIL

"One Good Turn - or a Million"

The **GRAMER COMPANY**  
(Formerly James W. Doyle, Inc.)

Electrical Coils and Transformers

2732 N. PULASKI RD. • CHICAGO 39, ILL.

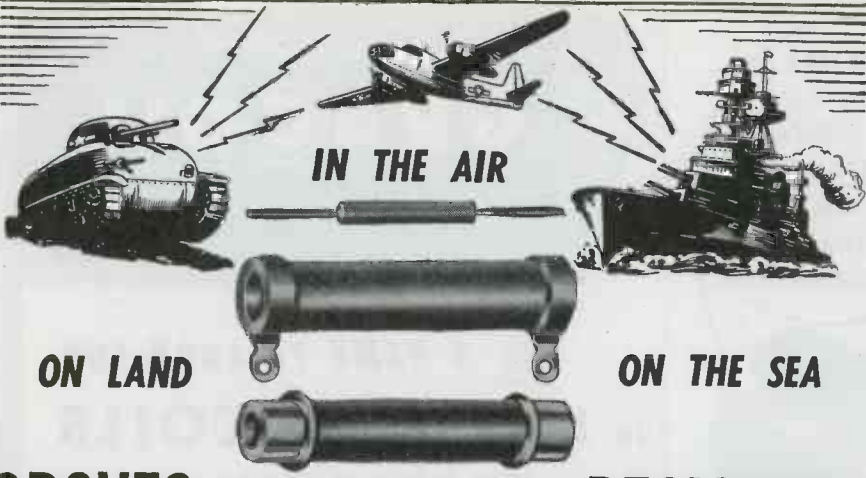

# GROVES *wire wound* RESISTORS

Steadily performing their assigned tasks in the teamwork essential to victory.

Accurate, rugged construction. Available in both high and low temperature coatings.

Catalog upon request

**GROVES**  
CORPORATION

CAPE GIRARDEAU      MISSOURI

engineers are needed for work in the headquarters in Washington, and development laboratories in New Jersey and elsewhere. The varied activities of these engineers include general research; study of radio transmission; design and development of radio transmitting and receiving equipment and radar installations, and the design of installations of radio and interphone equipment in tanks, armored cars, and trucks; design and development of automatic printing telegraph systems and telephone instruments, switchboards and communication networks; and preparation of technical manuals and instructional literature.

### Electrical engineers needed

In the Navy Department, electrical engineers are needed in various bureaus, but especially in the Bureau of Ships, where they work on design of electrical power, intercommunication and radio installations on ships; technical correspondence and procurement specifications for electrical and radio equipment; and layout of ship installations. They also serve as technical representatives of the Navy in conferences with manufacturers on design, development, production and procurement matters and witness and perform tests on equipment or installations.

In the Rural Electrification Administration, electrical engineers are needed in the headquarters at St. Louis and also in the various regional offices. These engineers review plans, specifications and construction contracts for generating stations and transmission systems; inspect installations and give engineering advice and assistance to REA financed cooperatives. They also analyze and prepare power contracts and rate schedules. Some travel is involved in these positions. Engineers are wanted who have had experience in the design and construction of power transmission and distribution lines, in electric rate studies, or in the engineering activities connected with the operation and maintenance of power systems. Experience in an engineering capacity with rural transmission lines or with REA cooperatives is especially desirable.

Engineers not now engaged in war work are urged to consider these opportunities for Federal work. Persons interested should write to the Civil Service Commission for its new folder "Electrical Engineers Serve in Federal War Jobs." Filing application with the Civil Service Commission in Washington is all that is necessary to make their services available for these positions. Appointments are war service appointments, and are made in accordance with War Manpower Commission policies and employment stabilization programs.

## New INLAY PROCESS

### ELIMINATES NAME PLATES ON FRONT PANELS

A proven method for placing durable characters on metal panels, chassis, etc.

- ★ Inlaid baked enamel characters, protected by background finish; resistant to abrasion and salt spray; guaranteed to pass 50 hour salt spray test.
- ★ Front panel will match finish of cabinets.
- ★ Recommended and endorsed by scores of manufacturers of electronic, sound and communication equipment.

PROMPT DELIVERIES—Send us your bare fabricated steel and within two weeks we will return it finished and marked to your complete satisfaction.



ALSO...  
SILK SCREENING on front panels and chassis, either metal or plastic. Sharp clear characters durably printed on finished or unfinished surfaces.



# SCREENMAKERS

64 FULTON STREET • NEW YORK 7, N.Y.

Tel.: REctor 2-9867

**Openings for**  
**RADIO**  
**ENGINEERS**  
**ELECTRICAL**  
**ENGINEERS**  
**MECHANICAL**  
**ENGINEERS**

In the development and production of all types of radio receiving and low-power transmitting tubes. Excellent post-war opportunities with an established company in a field having unlimited post-war possibilities.

Apply in person or in writing to:

Personnel Manager

**RAYTHEON**  
**MANUFACTURING CO.**

Radio Receiving Tube Div.

55 CHAPEL ST., NEWTON, MASS.

**\$1,000 EDITORIAL**  
**AWARDS**

☞ To encourage, through publication, the widest possible dissemination of electronic engineering information of the greatest practical value, Caldwell-Clements, Inc., Publisher of **ELECTRONIC INDUSTRIES**, announces Awards totalling \$1000 for articles or papers having to do with the application of electronic principles.

☞ Three Awards will be made—a First Award of \$600, a Second Award of \$300 and a Third Award of \$100—for articles or papers of outstanding significance that are published in the Editorial columns of **ELECTRONIC INDUSTRIES** during the remainder of the year 1945.

☞ Complete particulars of the Award offer were included in the March issue of **ELECTRONIC INDUSTRIES**. Correspondence with regard to the subject is welcomed by the Editors.

**CALDWELL-CLEMENTS, INC.**

Publisher—**ELECTRONIC INDUSTRIES**

480 Lexington Avenue New York 17, N. Y.



NOS. .0000, .000, .00 AND .0

ARE *Big* PRODUCTS

— big in their importance to the manufacture of precision instruments, for they are the *almost infinitesimal* screws that are used in the assemblies of many of the world's finest mechanical masterpieces.

For more than half a century Waltham has specialized in the production of *precision* screws. Its plant and equipment have steadily modernized and expanded to meet the demands of every period of business development and the exacting needs of three wars.

Waltham is tooled to produce fine screw machine products *for a million uses*— any thread, material or finish— any type head, from  $\frac{1}{64}$ " to  $1\frac{1}{2}$ " diameter.

America's Outstanding Producers of Fine Instrument Screws

Send for catalogue for complete data

**WALTHAM SCREW**  
**C O M P A N Y**  
 77 R u m f o r d A v e .  
 W a l t h a m , M a s s .

## PERSONNEL

(Continued from page 188)



**Dr. Norman A. Skow**, formerly of Bakelite Corp., has been appointed director of research, Synthane Corp., Oaks, Pa. Dr. Skow will devote his energies to research

and development of Synthane plastics for technical applications.

**Edmund A. Laport**, internationally prominent for his development and design of communications equipment, has been appointed chief engineer of the newly organized RCA International Division of Radio Corp. of America. Previously, he was on the staff of the chief engineer of the RCA Victor Division, working with the International Department. In this position he was responsible for engineering of communications systems and special apparatus in the international field. Prior to this appointment, Mr. Laport was chief engineer of the Engineering Products Division of RCA Victor Company, Ltd., of Canada. In this capacity he supervised the design and development of the major radio products of the RCA Victor Canadian Company, including ground and airborne radio, broadcast equipment, general communications equipment for the United Nations, and special apparatus for the Canadian armed forces.

**Norbert Shaeffer**, Hollywood industrial design engineer, has become affiliated with the Universal Microphone Co., Inglewood, Cal., in that capacity. His styling for the company will be in microphone housings and stands designed for sales appeal and consumer acceptance, without losing any of the practical aspects of engineering design.



**Dr. Lloyd Preston Smith**, professor of physics at Cornell University and a leading authority in the field of fundamental electronics, has been appointed associate research director of RCA Laboratories, Princeton, N. J.

His appointment fills a vacancy caused by the death last July of B. J. Thompson.

## METAL-TO-GLASS SEALS

Intricate glass work and tubes  
made to your specification

The Universal X-Ray plant specializes in the production of metal-to-glass seals. Intricate glass seals are made to customers' specifications for electronic tubes, transformers, resistors, capacitors, condensers, vibrators, switches, relays, instruments, gauges, meters, receivers, transmitters, and other scientific apparatus.

A strong metal-to-glass bond assures unflinching protection against rust, corrosion, and extreme climatic conditions in a vacuum-tight seal. Good deliveries can be made on volume orders. Submit your metal-to-glass seal problems to the Universal engineers for recommendations and estimates.

**UNIVERSAL X-RAY PRODUCTS INC.**  
1800-L N. FRANCISCO AVENUE • CHICAGO 47, ILLINOIS



**ZOPHAR**

## Fungus-Proofed Waxes

As a vital service to the Armed Forces we now offer Fungus Resistant Materials. These recently developed products are the answer to Communications requirements where the impregnation or coating of radio parts and equipment are concerned.

ZOPHAR waxes and compounds meet every specification of both the Army and Navy for waterproofing and insulating all electrical and radio components. They also have wide application in packaging of every description.

**ZOPHAR MILLS** INC

112-130—26th STREET  
BROOKLYN, N. Y.

ESTABLISHED 1846

TWO BOOKS EVERY ENGINEER NEEDS

## THE CATHODE-RAY TUBE AT WORK by John F. Rider



In using the Cathode-Ray Tube to its fullest capabilities, it is necessary to understand its theory and functioning. This book explains the various types and what role each element plays.

More than half the book is devoted to the practical applications illustrated with oscillograms.

338 PAGES . 450 ILLUSTRATIONS . \$4.00

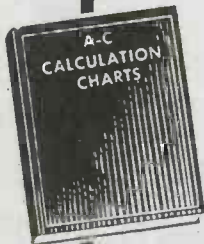

### A-C CALCULATION CHARTS

Faster than a slide rule. It covers all A-C calculations in series circuits, parallel circuits, series-parallel and mesh circuits, at frequencies from 10 cycles to 1000 megacycles. 146 Charts—7" x 11"—Two colors—\$7.50.

**JOHN F. RIDER PUBLISHER, INC.**

404 FOURTH AVENUE • NEW YORK 16, N. Y.

EXPORT DIV.: ROCKE-INTERNATIONAL CORP. 13 E. 40TH ST., NEW YORK

# 1,001 USES

## Condensed Power for Years of Service

VERSATILITY and dependability were paramount when Alliance designed these efficient motors—*Multum in Parvo!* . . . They are ideal for operating fans, movie projectors, light home appliances, toys, switches, motion displays, control systems and many other applications . . . providing economical condensed power for years of service.

## Alliance Precision

Our long established standards of precision manufacturing from highest grade materials are strictly adhered to in these models to insure long life without breakdowns.

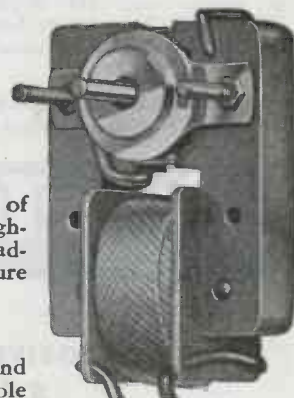

Model "MS"—Full Size Motor Measures 1 3/4" x 2 x 3 1/8"

### EFFICIENT

Both the new Model "K" Motor and the Model "MS" are the shaded pole induction type—the last word in efficient small motor design. They can be produced in all standard voltages and frequencies with actual measured power outputs ranging upwards to 1/100 H. P. . . Alliance motors also can be furnished, in quantity, with variations to adapt them to specific applications.

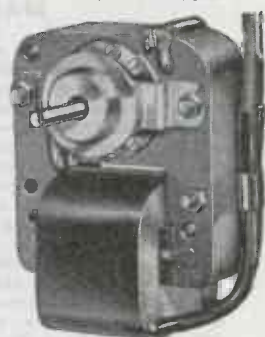

New Model "K"—Full Size Motor Measures 2 1/8" x 2 3/8" x 3 1/8"

### DEPENDABLE

Both these models uphold the Alliance reputation for all 'round dependability. In the busy post-war period, there will be many "spots" where these Miniature Power Plants will fit requirements . . . Write now for further information.

Remember Alliance!  
—YOUR ALLY IN WAR AS IN PEACE

# ALLIANCE MANUFACTURING CO.

ALLIANCE . OHIO

IN TIME OF

# WAR

PREPARE FOR

# PEACE

## PLASTIC BRANDING PLASTIC MOLDING

★ While molding and branding plastics that serve on all battle fronts, Rogan is also preparing for the peace that will follow. Preparing to meet the demand from peacetime industry for the many NEW applications of plastics. And when Peace does come, get Rogan facts on how you can get faster production of plastic parts at less cost.

Write now about your present War plastics and future Peace products.

## by ROGAN



**ROGAN BROTHERS**  
2007 SOUTH MICHIGAN AVENUE, CHICAGO, ILL.

# LASTING

## SMOOTH VOLTAGE CONTROL FOR 3 PHASE A. C. LEADS

Unusual shaft construction of new TH 2X, 2 1/2 A Transtat permits base to mounting, eliminates waste space. Controls smoothly in approximately 0.4 volt increments. Is highly efficient transformer type regulator, staunchly constructed for gruelling service. Excellent component or independent unit, regulates heat, light, motor speed, etc. Delta connected for three phase control or may simultaneously control two single phase circuits.

One piece brush arms have large heat dissipating area. Long brushes have low current density, run cooler. Cores and coils impregnated with vinyl acetate, providing solid insulation between segments of broad, smooth commutators. Companion piece to single unit TH 2 1/2 A Transtat. Bulletin 171-01 has construction details, electrical data. Write for it.



AMERICAN TRANSFORMER CO.  
178 Emmet Street, Newark 5, N. J.

# AMERTRAN

MANUFACTURING SINCE 1901 AT NEWARK, N. J.



NON-CORROSIVE

## Screw Machine Parts

MADE TO CLOSE TOLERANCES

DO your assemblies call for non-corrosive fastening devices or screw machine parts made to close tolerances? Allmetal has the "know how" and facilities to make such items accurately and economically, and to deliver them promptly. We have equipment for tapping, slotting, reaming, turning, stamping, broaching, drilling, threading and centerless grinding . . . and we work not only with stainless steel, but with monel, everdur, duralumin, brass, or other non-corrosive alloys. Write, wire or 'phone for our quotation.

Allmetal Screw Products Co.  
80 Grand St., New York 13, N. Y.

Send for  
FREE CATALOG

This new, 83-page catalog helps you select the correct size and type of non-corrosive fastening device for any particular job. Includes stock sizes, typical specials, engineering data, etc. Make request on company letterhead, please. Write to Dept. D

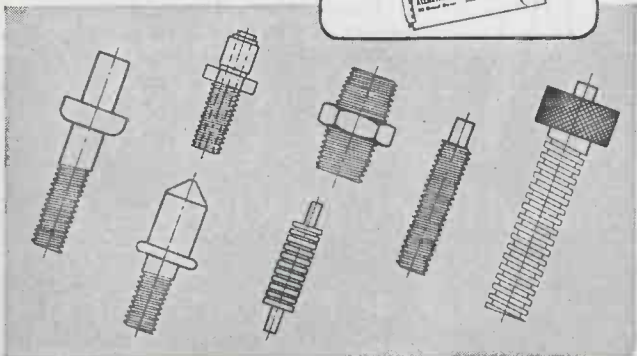

# EISLER EQUIPMENT

... the plus factor  
in tube manufacture



CHAS. EISLER specialized facilities are supplying high-efficiency manual, automatic and semi-automatic machinery for vacuum tube and electronic component production. Hundreds of devices are included — glass tube slicers, stem and sealing machines, flaring units, laboratory apparatus, etc.

(A) No. 161-WH Glass Tube Constriction Forming Machine draws, rapidly, automatically.

(B) No. 16-2S Two-Head Bench Type Flare Machine. Capable of rapid, efficient production. Simple operation.

(C) No. 23-12LD, new type 12 head giant Tipless Stem Machine.

(D) No. 11-TU Glass Tube Slicer, makes clean, sharp cuts—does not require skill.

(E) No. 57-X Laboratory Unit for glass cutting, flaring, stem making, sealing-in, exhausting, basing.

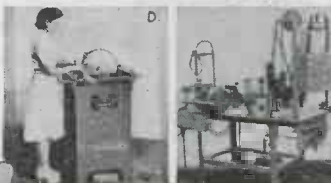
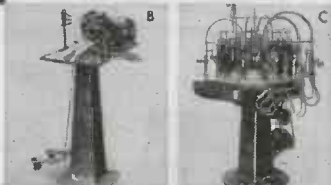

*Chas. Eisler*  
**Eisler**

## ENGINEERING COMPANY

778 SO. 13th STREET, NEWARK 3, N. J.

## WANTED

Electrical Engineer or Engineering Physicist for research position in fundamental and applied electronics. Some industrial experience preferred. Essential work with excellent post-war prospects. Write

## ARMOUR RESEARCH FOUNDATION

37 West 35th Street, Chicago 16,  
Illinois



MOTOR-GENERATOR

# ESCO

INDUSTRIAL  
MARINE  
AIRCRAFT  
ELECTRONICS

A complete line of a.c., d.c., and Universal motors; d.c. and all Freq. a.c. generators; motor-generators; converters; dynamotors; gas & Diesel Elec. plants; explosion proof units; Machines designed for every purpose.

## COMPLETE ENGINEERING SERVICE

Our engineers will be pleased to discuss your problems and aid in the design of machines to meet your requirements.

## ELECTRIC SPECIALTY CO.

214 SOUTH ST., STAMFORD, CONN.



# ELECTRONIC INDUSTRIES

Advertisers—May, 1945

	Page		Page		Page
Accurate Spring Mfg. Co.	133	Drake Electric Works, Inc.	230	Miller Electric Co.	263
Acme Electric Mfg. Co.	198	Drake Mfg. Co.	262	Morrow & Co., Publishers,	
Adams & Westlake Co.	21	Driver-Harris Co.	177	Wm.	230
Aerovox Corp.	70	Dumont Electric Co.	226	Mycalex Corp. of America	149
Aireon Mfg. Corp.	6	DuMont Laboratories, Inc.,		National Co.	217
Air Reduction	138	Allen B.	131, 170	National Vulcanized Fibre	
Ajax Electrothermic Corp.	17	Eicor, Inc.	216	Co.	199
Albion Coil Co.	36	Eitel-McCullough, Inc.	187	New Jersey Jewelers' Supply	40
Alliance Mfg. Co.	269	Eisler Engineering Co.	270	New York Transformer Co.	8, 9
Allied Radio Corp.	138	Electric Indicator Co.	234	North American Philips Co.	
Allmetal Screw Products Co.	270	Electric Soldering Iron Co.,		Inc.	219
Altec Lansing Corp.	126	Inc.	200	Norton Electrical Instrument	
Amalgamated Radio Television		Electric Specialty Co.	270	Co.	240
Corp.	221	Electronic Engineering Co.	242	Ohmite Mfg. Co.	42, 43
American Condenser Co.	229	Electronic Enterprises, Inc.	227	Patton-MacGuyver Co.	265
American Electrical Heater		Electronic Laboratories, Inc.	143	Permoflux Corp.	150
Co.	272	Electronic Products Mfg.		Pioneer Gen-E-Motor Corp.	176
American Gas Accumulator		Corp.	262	Premax Products	250
Co.	244	Elecro-Voice Corp.	58	Press Wireless, Inc.	265
American Lava Corp.	211	Erie Resistor Corp.	146	Presto Recording Corp.	44
American Phenolic Corp.	171	Federal Telephone & Radio		Printloid, Inc.	233
American Radio Hardware Co.,		Corp.	25, 71	Radell Corp.	258
Inc.	255	Fenwal, Inc.	272	Radex Corp.	228
American Television & Radio		Ferris Instrument Co.	68	Radiart Corp.	240
Co.	246	Finch Telecommunications,		Radio Corporation of America:	
American Time Products, Inc.	14	Inc.	190	RCA Victor Division	145,
American Transformer		Formica Insulation Co.	39		Cover 4
Co.	47, 270	Foster Co., A. P.	59	Radio Receptor Co., Inc.	249
Amperex Electronic Corp.	2	Freed Transformer Co.	166	Radio Specialties Co.	263
Amperite Co.	202	General Electric Co.	5, 16, 135,	Radio Wire Television, Inc.	196
Anaconda Wire & Cable Co.	13	168, 169, 179, 191, 223,		Rauland Corp.	66, 67
Andrew Co.	206	General Industries Co.	129	Raytheon Mfg. Co.	235, 257, 267
Ansonia Electrical Co.	29	General Instrument Corp.	157	R-B-M Mfg. Co.	154
Armour Research Foundation	270	Glyco Products Co., Inc.	63	Remler Co., Ltd.	239
Arnold Engineering Co.	38	Goat Metal Stampings, Inc.	226	Revere Copper & Brass, Inc.	7
Associated Electronics Corp.	272	Gramer Co.	265	Rider Publisher, Inc.,	
Associated Research, Inc.	196	Grayhill	265	John F.	269
Astatic Corp.	236	Green Electric Co., Inc.	218	Rogan Bros.	269
Automatic Electric Sales		Groves Corp.	266	Rothenstein, Albert	250
Corp.	180	Guardian Electric Mfg. Co.	117	Runzel Cord & Wire Co.	15
Barber Laboratories, Alfred		Hallcrafters Co.	132	Sangamo Electric Co.	124, 125
W.	222	Hammarlund Mfg. Co., Inc.	123	Schweitzer Paper Co.	73
Barker & Williamson	142	Hanovia Chemical & Mfg. Co.	172	"S" Corrugated Quenched Gap	
Bell Sound Systems, Inc.	254	Hardwick, Hindle, Inc.	182	Co.	189
Bell Telephone Laboratories	12	Harrison Radio Corp.	248	Scovill Mfg. Co.	147
Bendix Aviation Corp.:		Harvey Radio Co.	208	Screenmakers	266
Pacific Division	203	Harvey Radio Laboratories,		Seeburg Corp., J. P.	178
Bentley, Harris Mfg. Co.	195	Inc.	121	Selenium Corp. of America	271
Benwood Linze Co.	163	Hassall, Inc., John	214	Shallcross Mfg. Co.	201
Biddle Co., James G.	18	Heinemann Circuit Breaker		Sigma Instruments, Inc.	208
Bird & Co., Richard H.	150	Co.	153	Slater Corp., N. G.	151
Boonton Radio Corp.	128	Heintz & Kaufman, Ltd.	48	Snow, Inc., Cory	35
Bradley Laboratories, Inc.	183	Hexacon Electric Co.	229	Snyder Mfg. Co.	224
Bridgeport Mfg. Co.	192	Hickok Electrical Instrument		Solar Mfg. Corp.	11
Brush Development Co.	20	Co.	215	Special Chemicals Co.	228
Burgess Battery Co.	197	Houston Radio Supply Co.,		Spencer Wire Co.	34
Burdy Engineering Co.	185	Inc.	154	Sperry Gyroscope Co.	263
Burstein-Applebee Co.	272	Hytron Radio & Electronics		Sperti, Inc.	188
		Corp.	113	Sprague Electric Co.	186
Caldwell-Clements, Inc.	267	Illinois Condenser Co.	236	Stapokole Carbon Co.	213
Cambridge Thermionic Corp.	202	Indiana Steel Products Co.	72	Standard Transformer Corp.	130
Cannon Electric Development		Industrial & Commercial		Steward Stamping Co.	127
Co.	144	Electronics	64	Struthers-Dunn, Inc.	241
Capacitron Co.	194	Industrial Timer Corp.	258	Stupakoff Ceramic & Mfg.	
Cardwell Mfg. Corp.,		Instrument Resistors Corp.	159	Co.	24, 174
Allen D.	204	Insuline Corp. of America	234	Sun Radio & Electronics Co.	230
Carter Motor Co.	244	International Nickel Co.,		Superior Electric Co.	193
Celanese Corp. of America	139	Inc.	62	Surprenant Electrical	
Centralab	28	International Resistance Co.	45	Insulation Co.	200
Chicago Telephone Supply Co.	51	Jefferson Electric Co.	173	Sylvania Electric Products,	
Chicago Transformer Div. of		Jennings Radio Mfg. Co.	140	Inc.	184
Essex Wire Corp.	212	Jensen Radio Mfg. Co.	175	Taylor Fibre Co.	22
Cincinnati Electric Products		Johnson Co., E. F.	61, 220	Templeton Radio Mfg. Corp.	148
Co.	30, 31	Jones Co., Howard B.	248	Thomas & Skinner Steel	
Cinema Engineering Co.	272	Kahle Engineering Co.	261	Products Co.	256
Clare & Co., C. P.	69	Karp Metal Products Co.,		Thordarson Electric Mfg. Co.	247
ClaroStat Mfg. Co., Inc.	232	Inc.	251	Triplet Electrical Instrument	
Cohn & Co., Sigmund	142	Kenyon Transformer Co., Inc.	259	Co.	165
Cole Steel Equipment		Keuffel & Esser Co.	46	Tung-Sol Lamp Works, Inc.	10
Co.	210, 237	Knights Co., James	134	Turner Co.	260
Collins Radio Co.	55	Kurman Electric Co.	261	United Cinephone Corp.	224, 242
Colonial Kolonite Co.	144	Langevin Co.	119	United Electronics Co.	207
Communications Co., Inc.	156	Lapp Insulator Co., Inc.	245	United Screw & Bolt Corp.	50
Conant Electrical		Lavoie Laboratories	115	United Transformer Corp.	74
Laboratories	238	Lectrohm, Inc.	261	Universal Microphone Co.	243
Concord Radio Corp.	225	Leland Electric Co.	33	Universal X-Ray Products,	
Connecticut Telephone &		Macallen Co.	152	Inc.	268
Electric	26	Machlett Laboratories, Inc.	27	Utah Radio Product Co.	161
Continental Electric Co.	23	MacRae's Blue Book	261	Walker-Jimieson, Inc.	263
Cook Electric Co.	54	Magnavox Co.	155	Walsham Screw Co.	267
Cornell-Dubilier Electric Co.	37	Makepeace Co., L. E.	136	Ward Leonard Electric Co.	32
Corning Glass Works	41	Mallory & Co., Inc.,		Webster Chicago Corp.	137
Cornish Wire Co., Inc.	160	P. R.	Cover 2, 231, 252	Webster Electric Co.	158
Corry-Jamestown Mfg. Corp.	52	Marion Electrical Instrument		Weller Mfg. Co.	232
Coto-Coil Co., Inc.	209	Co.	141	Western Electric Co.	205, 228
Cramer Co., Inc., R. W.	221	Measurements Corp.	198	Westinghouse Electric & Mfg.	
Crystal Products Co.	164	Meck Industries, Inc., John	65	Co.	56, 57, 181
		Mec-Rad Division—		Weston Electrical Instrument	
Dalis, Inc., H. L.	214	Black Industries	49	Corp.	253
Daven Co.	Cover 3	Merit Coil & Transformer		Whitaker Cable Corp.	53
Delco Radio Div. of		Corp.	4	Willor Mfg. Corp.	264
General Motors	162	Micamold Radio Corp.	19	Wrigley Co., Wm.	256
Deutschmann Corp., Tobe	162	Micro Switch Corp.	60	Zophar Mills, Inc.	268
Dial Light Co. of America,		Millen Mfg. Co., Inc., James	220		
Inc.	22				
Dow Chemical Co.	167				

NUMBER ONE OF A SERIES

**DC**  
means  
**SC**

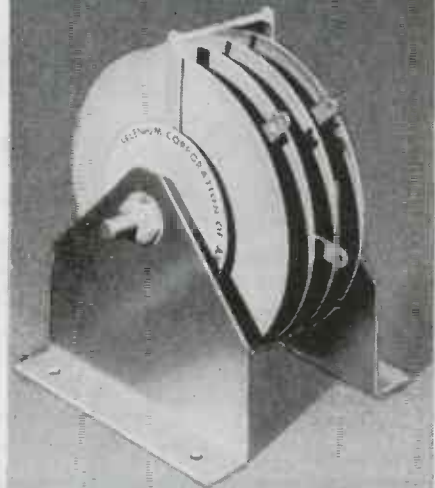

DC means SC... Selenium Control and Selenium Conversion for the practical, profitable performance planned by top flight design engineers. Selenium provides maximum efficiency... unlimited life... negative temperature coefficient... and other characteristics necessary to solve the electronic problems of tomorrow... That's why DC means SC.

SEND FOR BULLETIN

**SELENIUM CORPORATION of AMERICA**

1719 WEST PICO BOULEVARD  
LOS ANGELES 15, CALIFORNIA

EXPORT DIVISION: FRAZER & HANSEN  
301 CLAY STREET, SAN FRANCISCO, CALIFORNIA

IN CANADA: BURELCO LTD., TORONTO 13, ONTARIO, CANADA

**DEPENDABLE**

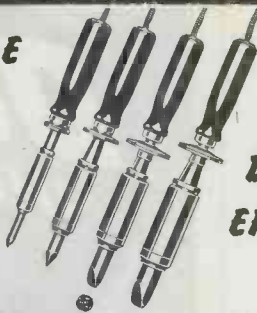

**DURABLE  
EFFICIENT**

# American Beauty



**TEMPERATURE  
REGULATING STAND**

A thermostatically controlled stand for regulating the temperature of an electric soldering iron when at rest. The thermostat is adjustable for various heats.

**ELECTRIC  
SOLDERING IRON**

Preferred by those who measure the value of a tool by the service it renders. Soldering irons are made in 5 sizes and for low as well as standard voltage.

Write for Catalog Sheets.

108-1

**AMERICAN ELECTRICAL HEATER COMPANY**  
DETROIT 2, MICHIGAN, U. S. A.

MEMO:

*Too busy  
this month, making  
Variatens for the  
war effort, to write  
copy for ads.  
Yours truly  
Art Davis*

**CINEMA ENGINEERING CO.**

1508 W. VERDUGO AVE. • BURBANK, CALIF.

## ASSOCIATED ELECTRONICS

**Corporation, Consulting Engineers**

Complete engineering service for industry—electrical, mechanical, chemical, electro-chemical and industrial engineering divisions to handle your product or production problems from start to finish.

132 Nassau Street • New York 7, N. Y.  
251 Kearney Street • San Francisco 8, Cal.

**NATION-WIDE MAIL  
ORDER DISTRIBUTORS  
SINCE 1928**



**RADIO AND ELECTRONIC**

DEVICES For Trade... Industry... Vocational  
... Communication... Public Utility and Ex-  
perimental Applications

**BURSTEIN-APPLEBEE CO.**

1012-14 McGee St. Kansas City 6, Missouri

## LEASE ON LIFE! ... through THERMOSWITCHES

Baby Incubators—essential to maintaining life in babies born prematurely—are temperature-controlled by accurate, sensitive Fenwal THERMOSWITCHES.



Write for catalogue and complete information ... to

**Fenwal** INCORPORATED  
ASHLAND • MASS.

# DAVEN

## ATTENUATORS

The many different networks (illustrated) and the wide selection of characteristics variations comprising the standard lines of DAVEN attenuators, are features of great convenience to the engineer—in Radio Broadcasting, in Sound Recording, Sound Projection, in Television and in the Laboratory Equipment field. Likewise, advanced designing as embodied in recent DAVEN announcements, plus a long standing reputation for making a good product, are facts that merit consideration in your present and post-war plans.

### Balanced Circuits

### Unbalanced Circuits

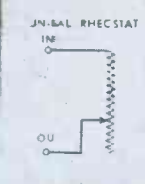
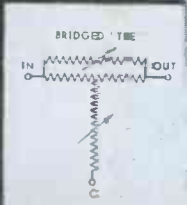
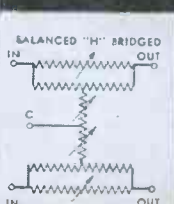
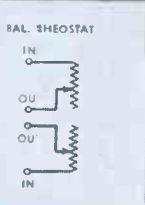
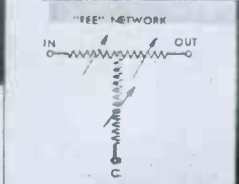
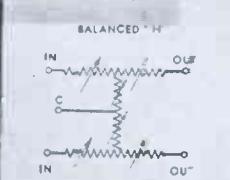
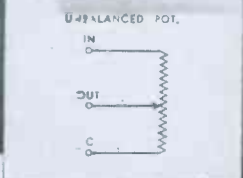
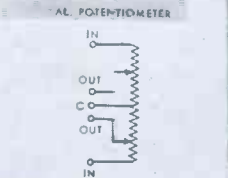
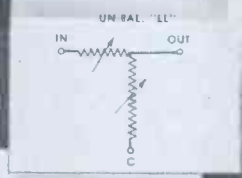
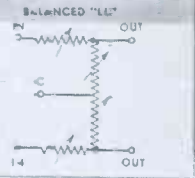
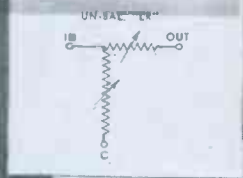
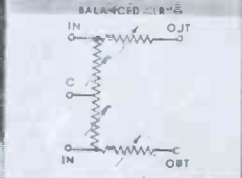
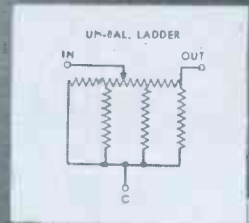
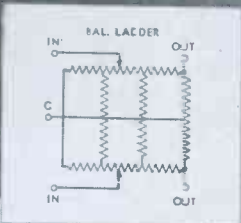

**BETTER DELIVERIES**  
 Several standard types of DAVEN Attenuators are available in moderate quantities for prompt deliveries. 30 to 60 day delivery is being made at this time on many other standard and some special types.

THE **DAVEN** COMPANY  
 191 CENTRAL AVENUE  
 NEWARK 4, NEW JERSEY

BUY MORE... HOLD MORE... WAR BONDS

**NEITHER STRATOSPHERE  
COLD NOR DESERT HEAT  
AFFECT THE RCA-3B25**



**Xenon-Filled Rectifier Tube  
Operates Efficiently Over  
165°C Temperature Range**

FOR applications in which ambient temperature varies widely, the 3B25 has important advantages over mercury-vapor-type tubes. No temperature-control devices are required, arc-back is minimized, and the tube drop remains constant at approximately 10 volts over the entire temperature range from  $-75^{\circ}\text{C}$  to  $+90^{\circ}\text{C}$ .

The RCA-3B25 also will carry higher currents than high-vacuum tubes of the same size—and with much lower tube drop.

The Xenon filling permits operation of the tube mounted in any position. Since the 3B25 is ruggedly constructed to

withstand severe shock, it can be mounted near moving mechanisms without being adversely affected by vibration.

**TECHNICAL DATA**

In single-phase, full-wave operation, a pair of 3B25's will provide 1 ampere d-c output to the filter at 1270 volts. The tube is rated at 4500 peak inverse anode volts and an average anode current of 0.5 ampere.

**General:** Filament volts (a.c.), 2.5; filament current, 5.0 amperes; tube drop (approx.) 10 volts; overall length,  $5\frac{7}{8}$  inches  $\pm\frac{1}{16}$  inch; maximum diameter,  $2\frac{1}{16}$  inches; cap, medium; base, medium 4-pin bayonet; mounts in any position.

**Maximum Ratings (Absolute Values):** Peak inverse anode volts (at 500 cycles or less), 4000; peak anode current, 2 amperes; average anode current, 0.5 ampere; surge anode current for maximum of 0.1 second, 20 amperes; ambient temperature range,  $-75^{\circ}\text{C}$  to  $+90^{\circ}\text{C}$ .

For more complete data, send for free data-sheet on RCA-3B25. Address: RADIO CORPORATION OF AMERICA, Commercial Engineering Section, Dept. 62-31J, Harrison, New Jersey.

BUY WAR BONDS



62-6136-31

**RADIO CORPORATION OF AMERICA**

RCA VICTOR DIVISION • CAMDEN, NEW JERSEY

**THE FOUNTAINHEAD OF MODERN TUBE  
DEVELOPMENT IS RCA**